

# User's Manual

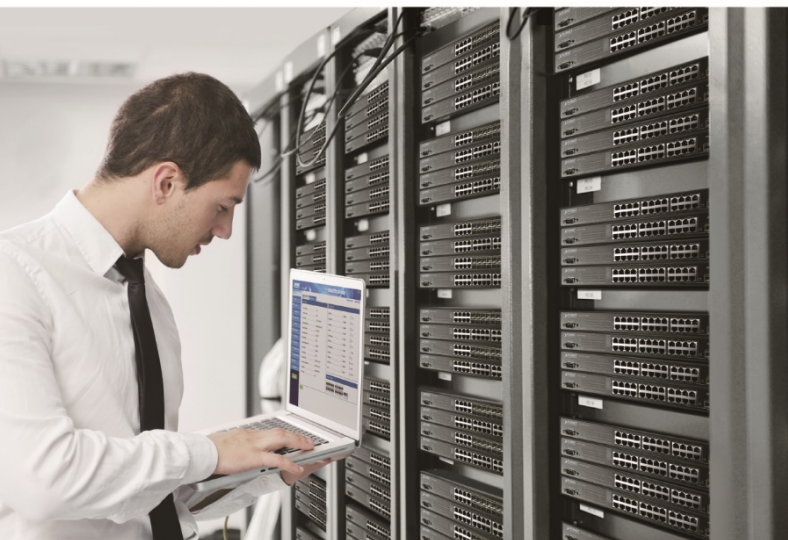

## L3 Industrial Managed Ethernet Switch

▶ IGS-6325 DIN-rail Series



## Trademarks

Copyright © PLANET Technology Corp. 2019.

Contents are subject to revision without prior notice.

PLANET is a registered trademark of PLANET Technology Corp. All other trademarks belong to their respective owners.

## Disclaimer

PLANET Technology does not warrant that the hardware will work properly in all environments and applications, and makes no warranty and representation, either implied or expressed, with respect to the quality, performance, merchantability, or fitness for a particular purpose. PLANET has made every effort to ensure that this User's Manual is accurate; PLANET disclaims liability for any inaccuracies or omissions that may have occurred.

Information in this User's Manual is subject to change without notice and does not represent a commitment on the part of PLANET. PLANET assumes no responsibility for any inaccuracies that may be contained in this User's Manual. PLANET makes no commitment to update or keep current the information in this User's Manual, and reserves the right to make improvements to this User's Manual and/or to the products described in this User's Manual, at any time without notice.

If you find information in this manual that is incorrect, misleading, or incomplete, we would appreciate your comments and suggestions.

## FCC Warning

This equipment has been tested and found to comply with the limits for a Class A digital device, pursuant to Part 15 of the FCC Rules. These limits are designed to provide reasonable protection against harmful interference when the equipment is operated in a commercial environment. This equipment generates, uses, and can radiate radio frequency energy and, if not installed and used in accordance with the Instruction manual, may cause harmful interference to radio communications. Operation of this equipment in a residential area is likely to cause harmful interference in which case the user will be required to correct the interference at his own expense.

## CE Mark Warning

This device is compliant with Class A of CISPR 32. In a residential environment this equipment may cause radio interference.

## Energy Saving Note of the Device

This power required device does not support Standby mode operation. For energy savings, please remove the power cable to disconnect the device from the power circuit. Without removing the power cable, the device will still consume power from the power source. In view of Saving the Energy and reducing the unnecessary power consumption, it is strongly suggested to remove the power cable from the device if this device is not intended to be active.

## WEEE Warning



To avoid the potential effects on the environment and human health as a result of the presence of hazardous substances in electrical and electronic equipment, end users of electrical and electronic equipment should understand the meaning of the crossed-out wheeled bin symbol. Do not dispose of WEEE as unsorted municipal waste and have to collect such WEEE separately.

## Revision

User's Manual of PLANET Industrial L3 Managed Switch

FOR MODELS: IGS-6325-16P4S, IGS-6325-8UP2S2X, IGS-6325-8T8S and IGS-6325-8T8S4X

REVISION: 1.1 (Dec., 2019)

Part No: EM-IGS-6325 DIN-rail Series\_v1.1

## TABLE OF CONTENTS

<b>1. INTRODUCTION.....</b>	<b>11</b>
1.1 Packet Contents .....	11
1.2 Product Description.....	12
1.3 How to Use This Manual.....	19
1.4 Product Features.....	20
1.5 Product Specifications .....	24
<b>2. INSTALLATION .....</b>	<b>34</b>
2.1 Hardware Description .....	34
2.1.1 Physical Dimensions.....	35
2.1.2 Front Panel.....	36
2.1.3 LED Indications .....	39
2.1.4 Switch Upper Panel .....	44
2.1.5 Wiring the DC Power Input .....	46
2.1.6 Wiring the Fault Alarm Contact .....	47
2.1.7 Wiring the Digital Input/Output.....	48
2.2 Installing the Industrial Managed Switch .....	50
2.2.1 Installation Steps.....	50
2.2.2 DIN-rail Mounting.....	51
2.2.3 Wall-mount Plate Mounting.....	53
2.3 Cabling .....	54
2.3.1 Installing the SFP Transceiver.....	55
2.3.2 Removing the SFP/SFP+ Transceiver .....	58
<b>3. SWITCH MANAGEMENT .....</b>	<b>59</b>
3.1 Requirements .....	59
3.2 Management Access Overview .....	60
3.3 CLI Mode Management.....	61
3.3.1 Logging on to the Console .....	62
3.3.2 Remote Telnet .....	63
3.4 Web Management.....	64
3.5 SNMP-based Network Management.....	65
3.6 PLANET Smart Discovery Utility .....	66
<b>4. WEB CONFIGURATION .....</b>	<b>68</b>
4.1 Main Web page .....	71
4.2 System .....	73
4.2.1 Management.....	74

4.2.1.1 System Information.....	74
4.2.1.2 IP Configuration.....	75
4.2.1.3 IP Status.....	79
4.2.1.4 Users Configuration.....	80
4.2.1.5 Privilege Levels .....	83
4.2.1.6 NTP Configuration .....	85
4.2.1.6.1 System Time Correction Manually.....	86
4.2.1.7 Time Configuration .....	87
4.2.1.8 UPnP.....	89
4.2.1.9 DHCP Relay .....	90
4.2.1.10 DHCP Relay Statistics.....	92
4.2.1.11 CPU Load .....	94
4.2.1.12 System Log .....	95
4.2.1.13 Detailed Log .....	96
4.2.1.14 Remote Syslog.....	97
4.2.1.15 SMTP Configuration .....	98
4.2.1.16 Fault Alarm .....	100
4.2.1.17 Digital Input/Output.....	102
<b>4.2.2 Simple Network Management Protocol .....</b>	<b>105</b>
4.2.2.1 SNMP Overview .....	105
4.2.2.2 SNMP System Configuration.....	106
4.2.2.3 SNMP System Information .....	107
4.2.2.4 SNMP Trap Configuration.....	108
4.2.2.5 SNMP Trap Source Configuration .....	110
4.2.2.6 SNMPv3 Communities .....	112
4.2.2.7 SNMPv3 Users.....	113
4.2.2.8 SNMPv3 Groups .....	115
4.2.2.9 SNMPv3 Views.....	116
4.2.2.10 SNMPv3 Access .....	117
<b>4.2.3 RMON .....</b>	<b>119</b>
4.2.3.1 RMON Alarm Configuration .....	119
4.2.3.2 RMON Alarm Status .....	121
4.2.3.3 RMON Event Configuration.....	122
4.2.3.4 RMON Event Status .....	123
4.2.3.5 RMON History Configuration.....	124
4.2.3.6 RMON History Status .....	125
4.2.3.7 RMON Statistics Configuration.....	126
4.2.3.8 RMON Statistics Status.....	127
<b>4.2.4 DHCP server.....</b>	<b>129</b>
4.2.4.1 DHCP Server Mode Configuration.....	129
4.2.4.2 DHCP Server excluded IP Configuration.....	131



4.2.4.3 DHCP Server pool Configuration.....	132
4.2.4.4 DHCP Server pool Configuration.....	133
4.2.4.5 DHCP Server Binding IP Configuration .....	135
4.2.4.6 DHCP Server Declined IP .....	136
4.2.4.7 DHCP Detail Statistics.....	136
<b>4.2.5 Industrial Protocol.....</b>	<b>138</b>
4.2.5.1 Protocol Configuration.....	138
<b>4.3 Switching .....</b>	<b>139</b>
<b>4.3.1 Port Management .....</b>	<b>139</b>
4.3.1.1 Port Configuration .....	139
4.3.1.2 Port Statistics Overview.....	141
4.3.1.3 Port Statistics Details.....	142
4.3.1.4 SFP Module Information.....	144
4.3.1.5 Port Mirror .....	145
<b>4.3.2 Link Aggregation .....</b>	<b>149</b>
4.3.2.1 Static Aggregation .....	152
4.3.2.2 Static Aggregation Status .....	154
4.3.2.3 LACP Configuration.....	154
4.3.2.4 LACP System Status .....	156
4.3.2.5 LACP Internal Port Status .....	157
4.3.2.6 LACP Neighbor Port Status.....	158
4.3.2.7 LACP Port Statistics .....	159
<b>4.3.3 VLAN.....</b>	<b>160</b>
4.3.3.1 VLAN Overview .....	160
4.3.3.2 IEEE 802.1Q VLAN .....	161
4.3.3.3 VLAN Port Configuration .....	164
4.3.3.4 VLAN Membership Status .....	170
4.3.3.5 VLAN Port Status .....	172
4.3.3.6 Private VLAN.....	173
4.3.3.7 Port Isolation .....	175
4.3.3.8 VLAN setting example:.....	177
4.3.3.8.1 Two Separate 802.1Q VLANs .....	177
4.3.3.8.2 VLAN Trunking between two 802.1Q aware switches .....	179
4.3.3.8.3 Port Isolate .....	182
4.3.3.9 MAC-based VLAN .....	183
4.3.3.10 IP Subnet-based VLAN Membership Configuration.....	184
4.3.3.11 Protocol-based VLAN .....	185
4.3.3.12 Protocol-based VLAN Membership .....	186
<b>4.3.4 Spanning Tree Protocol .....</b>	<b>189</b>
4.3.4.1 Theory .....	189
4.3.4.2 STP System Configuration .....	195

4.3.4.3 Bridge Status .....	197
4.3.4.4 CIST Port Configuration .....	198
4.3.4.5 MSTI Priorities .....	201
4.3.4.6 MSTI Configuration.....	202
4.3.4.7 MSTI Ports Configuration .....	203
4.3.4.8 Port Status.....	205
4.3.4.9 Port Statistics .....	206
<b>4.3.5 Multicast.....</b>	<b>207</b>
4.3.5.1 IGMP Snooping .....	207
4.3.5.2 Profile Table.....	210
4.3.5.3 Address Entry .....	212
4.3.5.4 IGMP Snooping Configuration.....	213
4.3.5.5 IGMP Snooping VLAN Configuration.....	214
4.3.5.6 IGMP Snooping Port Group Filtering .....	216
4.3.5.7 IGMP Snooping Status .....	217
4.3.5.8 IGMP Group Information .....	219
<b>4.3.6 MLD Snooping .....</b>	<b>220</b>
4.3.6.1 MLD Snooping Configuration .....	220
4.3.6.2 MLD Snooping VLAN Configuration .....	221
4.3.6.3 MLD Snooping Port Group Filtering .....	223
4.3.6.4 MLD Snooping Status.....	224
4.3.6.5 MLD Group Information .....	225
4.3.6.6 MLDv2 Information .....	227
<b>4.3.7 MVR (Multicast VLAN Registration).....</b>	<b>229</b>
4.3.7.1 MVR Configuration .....	229
4.3.7.2 MVR Status .....	232
4.3.7.3 MVR Groups Information.....	233
4.3.7.4 MVR SFM Information .....	233
<b>4.3.8 LLDP .....</b>	<b>235</b>
4.3.8.1 Link Layer Discovery Protocol .....	235
4.3.8.2 LLDP Configuration .....	235
4.3.8.3 LLDP Neighbor.....	238
4.3.8.4 LLDP MED Configuration .....	240
4.3.8.5 LLDP-MED Neighbor.....	248
4.3.8.6 Port Statistics .....	252
<b>4.3.9 MAC Address Table .....</b>	<b>255</b>
4.3.9.1 MAC Table Configuration.....	255
4.3.9.2 MAC Address Table Status.....	257
<b>4.3.10 Loop Protection .....</b>	<b>259</b>
4.3.10.1 Configuration .....	259
4.3.10.2 Loop Protection Status .....	260

<b>4.3.11 UDLD</b> .....	<b>261</b>
4.3.11.1 UDLD Port Configuration .....	261
4.3.11.2 UDLD Status .....	262
<b>4.3.12 GVRP</b> .....	<b>264</b>
4.3.12.1 GVRP Configuration .....	264
4.3.12.2 GVRP Port Configuration .....	265
<b>4.3.13 PTP</b> .....	<b>266</b>
4.3.13.1 PTP Configuration .....	267
<b>4.3.14 Link OAM</b> .....	<b>276</b>
4.3.14.1 Statistics .....	276
4.3.14.2 Port Status.....	278
4.3.14.3 Event Status .....	280
4.3.14.4 Port Settings .....	282
4.3.14.5 Event Settings .....	284
4.3.14.6 MIB Retrieval.....	285
4.3.14.7 Link-OAM Example.....	286
<b>4.4 Quality of Service</b> .....	<b>287</b>
<b>4.4.1 General</b> .....	<b>287</b>
4.4.1.1 QoS Port Classification.....	288
4.4.1.2 Queue Policing .....	289
4.4.1.3 Port Tag Remarking.....	290
4.4.1.4 WRED .....	291
4.4.1.5 Statistics .....	292
<b>4.4.2 Bandwidth Control</b> .....	<b>294</b>
4.4.2.1 Port Policing .....	294
4.4.2.2 Port Schedule.....	295
4.4.2.3 Port Shaping.....	296
<b>4.4.3 Storm Control</b> .....	<b>299</b>
4.4.3.1 Storm Policing Configuration.....	299
<b>4.4.4 Differentiated Service</b> .....	<b>300</b>
4.4.4.1 Port DSCP .....	300
4.4.4.2 DSCP-based QoS .....	302
4.4.4.3 DSCP Translation .....	302
4.4.4.4 DSCP Classification .....	304
<b>4.4.5 QCL</b> .....	<b>305</b>
4.4.5.1 QoS Control List.....	305
4.4.5.2 QoS Control Entry Configuration .....	307
4.4.5.3 QCL Status .....	309
4.4.5.4 Voice VLAN Configuration .....	311
4.4.5.5 Voice VLAN OUI Table .....	313
<b>4.5 Security</b> .....	<b>314</b>

<b>4.5.1 Access Security</b> .....	<b>314</b>
4.5.1.1 Access Management .....	314
4.5.1.2 Access Management Statistics .....	315
4.5.1.3 SSH .....	317
4.5.1.4 HTTPs .....	318
<b>4.5.2 AAA</b> .....	<b>320</b>
4.5.2.1 Authentication Configuration .....	324
4.5.2.2 RADIUS .....	327
4.5.2.3 TACACS+ .....	329
4.5.2.4 RADIUS Overview .....	330
4.5.2.5 RADIUS Details .....	333
<b>4.5.3 Port Authentication</b> .....	<b>340</b>
4.5.3.1 Network Access Server Configuration .....	340
4.5.3.2 Network Access Overview .....	344
4.5.3.3 Network Access Statistics .....	345
<b>4.5.4 Port Security</b> .....	<b>350</b>
4.5.4.1 Port Limit Control .....	350
4.5.4.2 Port Security Status .....	353
4.5.4.3 Port Security Detail .....	356
<b>4.5.5 Access Control Lists</b> .....	<b>358</b>
4.5.5.1 Access Control List Status .....	358
4.5.5.2 Access Control List Configuration .....	360
4.5.5.3 ACE Configuration .....	362
4.5.5.4 ACL Ports Configuration .....	371
4.5.5.5 ACL Rate Limiters .....	374
<b>4.5.6 DHCP Snooping</b> .....	<b>375</b>
4.5.6.1 DHCP Snooping Configuration .....	375
4.5.6.2 Snooping Table .....	377
<b>4.5.7 IP Source Guard</b> .....	<b>378</b>
4.5.7.1 IP Source Guard Configuration .....	378
4.5.7.2 Static IP Source Guard Table .....	379
4.5.7.3 Dynamic IP Source Guard Table .....	380
<b>4.5.8 ARP Inspection</b> .....	<b>381</b>
4.5.8.1 ARP Inspection .....	381
4.5.8.2 ARP Inspection Static Table .....	382
4.5.8.3 Dynamic ARP Inspection Table .....	383
<b>4.6 Ring</b> .....	<b>385</b>
<b>4.6.1 ERPS Ring</b> .....	<b>385</b>
4.6.1.1 MEP Configuration .....	386
4.6.1.2 Detailed MEP Configuration .....	388
4.6.1.3 Ethernet Ring Protocol Switch .....	394

4.6.1.4 Ethernet Ring Protocol Switch Configuration.....	396
4.6.1.5 Ethernet Ring Protocol Switch.....	399
4.6.1.6 Ring Wizard Example.....	400
<b>4.7 Maintenance .....</b>	<b>403</b>
<b>4.7.1 Switch Maintenance .....</b>	<b>403</b>
4.7.1.1 Web Firmware Upgrade .....	403
4.7.1.2 Save Startup Config .....	404
4.7.1.3 Configuration Download .....	404
4.7.1.4 Configuration Upload.....	405
4.7.1.5 Configuration Activate.....	406
4.7.1.6 Configuration Delete.....	406
4.7.1.7 Image Select .....	407
4.7.1.8 Factory Default.....	408
4.7.1.9 System Reboot.....	408
<b>4.7.2 Diagnostics .....</b>	<b>409</b>
4.7.2.1 Ping.....	410
4.7.2.2 IPv6 Ping.....	411
4.7.2.3 Remote IP Ping Test.....	412
4.7.2.4 Cable Diagnostics .....	413
<b>4.8 Power over Ethernet .....</b>	<b>415</b>
<b>4.8.1 PoE Switch Introduction .....</b>	<b>415</b>
<b>4.8.2 Power over Ethernet Powered Device .....</b>	<b>416</b>
<b>4.8.3 PoE System Configuration .....</b>	<b>418</b>
<b>4.8.4 Port Configuration.....</b>	<b>421</b>
<b>4.8.5 PoE Status.....</b>	<b>425</b>
<b>4.8.6 Port Sequential .....</b>	<b>427</b>
<b>4.8.7 PoE Schedule.....</b>	<b>428</b>
<b>4.8.8 PoE Alive Check Configuration.....</b>	<b>431</b>
<b>4.8.9 LLDP PoE Neighbors.....</b>	<b>433</b>
<b>4.9 ONVIF .....</b>	<b>434</b>
<b>4.9.1 ONVIF Switch Introduction .....</b>	<b>434</b>
<b>4.9.2 ONVIF Device Search.....</b>	<b>435</b>
<b>4.9.3 ONVIF Device List.....</b>	<b>437</b>
<b>4.9.4 Map Upload / Edit .....</b>	<b>439</b>
<b>4.9.5 Floor Map .....</b>	<b>440</b>
<b>4.10 Routing.....</b>	<b>442</b>
<b>4.10.1 IP Configuration.....</b>	<b>442</b>
<b>4.10.2 IP Status .....</b>	<b>445</b>
<b>4.10.3 Routing Information Base.....</b>	<b>446</b>
<b>4.10.4 OSPF.....</b>	<b>448</b>
4.10.4.1 Global Configuration.....	449

4.10.4.2 Network Area .....	451
4.10.4.3 Passive Interface .....	452
4.10.4.4 Stub Area.....	453
4.10.4.5 Area Authentication.....	454
4.10.4.6 Area Range .....	455
4.10.4.7 Interface Configuration .....	456
4.10.4.8 Virtual Link.....	458
4.10.4.9 Global Status.....	460
4.10.4.10 Area Status .....	461
4.10.4.11 Neighbor Status .....	462
4.10.4.12 Interface Status .....	463
4.10.4.13 Configuration Example of OSPFv4.....	465
<b>5. SWITCH OPERATION .....</b>	<b>469</b>
5.1 Address Table.....	469
5.2 Learning .....	469
5.3 Forwarding & Filtering.....	469
5.4 Store-and-Forward .....	469
5.5 Auto-Negotiation .....	470
<b>6. TROUBLESHOOTING.....</b>	<b>471</b>
<b>APPENDIX A: Networking Connection .....</b>	<b>473</b>
A.1 Switch's Data RJ45 Pin Assignments - 1000Mbps, 1000BASE-T .....	473
A.2 10/100Mbps, 10/100BASE-TX .....	473
<b>APPENDIX B : GLOSSARY .....</b>	<b>475</b>

# 1. INTRODUCTION

Thank you for purchasing PLANET IGS-6325 Industrial Managed Switch series, which comes with multiple Gigabit Ethernet copper ports and SFP/SFP+ fiber optic connectivity, and robust Layer 3 features in an IP30 rugged metal case.

“Industrial Managed Switch” is used as an alternative name in this user’s manual.

## 1.1 Packet Contents

Open the box of the Industrial Managed Switch and carefully unpack it. The box should contain the following items:

Model Name Item	IGS-6325-16P4S	IGS-6325-8UP2S2X	IGS-6325-8UP2S	IGS-6325-8T8S4X	IGS-6325-8T4X	IGS-6325-8T8S
The Industrial Managed Switch	■	■	■	■	■	■
Quick Installation Guide	■	■	■	■	■	■
RS232 to RJ45 Console Cable	■	■	■	■	■	■
Wall Mounting Kit	■	■	■	■	■	■
RJ45 Dust Caps	17	9	9	9	9	9
SFP/SFP+ Dust Cap	4	4	2	12	4	8

If any of these are missing or damaged, please contact your dealer immediately.



## 1.2 Product Description

PLANET IGS-6325 series, an Industrial Layer 3 Managed Switch that features multiple Gigabit TP/SFP ports and up to 4 10G SFP+ ports in an **IP30** rugged metal case, can be installed in any difficult environment. With high-density interfaces and large capacity, the IGS-6325 series can handle extremely large amounts of data in a secure topology linking to an industrial backbone or high capacity servers.

Model Name Item	IGS-6325-16P4S	IGS-6325-8UP2S	IGS-6325-8UP2S2X	IGS-6325-8T8S4X	IGS-6325-8T4X	IGS-6325-8T8S
10/100/1000BASE-T Copper	16	8	8	8	8	8
100/1000BASE-X SFP	4	2	2	8	--	8
10GBASE-SR/LR SFP+	--	--	2	4	4	--
Power over Ethernet Standard	IEEE 802.3at PoE+	IEEE 802.3bt PoE++	IEEE 802.3bt PoE++	--	--	--
PoE Ports	16	8	8	--	--	--
PoE Budget	320 watts	360 watts	360 watts	--	--	--
Power Input	48-56V DC x 2			12~48V DC x 2 or 24V AC		

The IGS-6325 series is capable of providing non-blocking switch fabric and wire-speed throughput. It greatly simplifies the tasks of upgrading the industrial LAN for catering to increasing bandwidth demands.

### Advanced Manageable Solution for Hardened Environment

The IGS-6325 series provides user-friendly yet advanced **IPv6/IPv4 management** interfaces, abundant **L2/L4 switching functions**, **Layer 3 OSPFv2 dynamic routing** capability, and advanced **ITU-G.8032 ERPS Ring** technology to improve the rapid self-recovery capability. The IGS-6325 PoE models featuring PLANET **intelligent PoE** functions for controlling the PoE outdoor IP surveillance and wireless network applications. It is able to operate reliably, stably and quietly in the temperature range from **-40 to 75 degrees C**

### Layer 3 Routing Support

The IGS-6325 series enables the administrator to conveniently boost network efficiency by configuring Layer 3 IPv4/IPv6 VLAN static routing manually, and the IPv4 OSPFv2 (Open Shortest Path First) settings automatically. The OSPF is an interior dynamic routing protocol for autonomous system based on link state. The protocol creates a database for link state by exchanging link states among Layer 3 switches, and then uses the Shortest Path First algorithm to generate a route table based on that database.

### Cybersecurity Network Solution to Minimize Security Risks

The IGS-6325 Series supports SSHv2, TLS and SSL protocols to provide strong protection against advanced threats. It includes a range of cybersecurity features such as **DHCP Snooping**, **IP Source Guard**, **ARP Inspection** Protection, **802.1x port-based** and **MAC-based** network access control, **RADIUS** and **TACACS+** user accounts management, **SNMPv3** authentication, and so on to complement it as an all-security solution.



### Redundant Ring, Fast Recovery for Critical Network Applications

The IGS-6325 series supports redundant ring technology and features strong, rapid self-recovery capability to prevent interruptions and external intrusions. It incorporates advanced **ITU-T G.8032 ERPS (Ethernet Ring Protection Switching)** technology, Spanning Tree Protocol (802.1s MSTP), and **redundant power** input system into customer's industrial automation network to enhance system reliability and uptime in harsh factory environments. In a simple Ring network, the recovery time of data link can be as fast as 10ms.

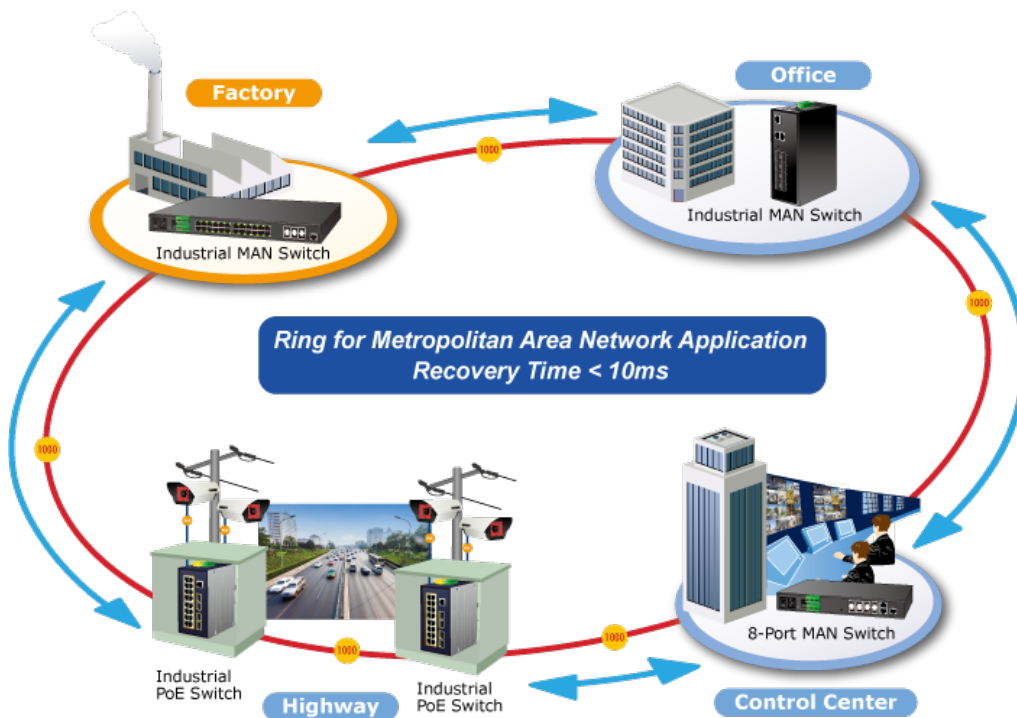

### Modbus TCP Provides Flexible Network Connectivity for Factory Automation

With the supported Modbus TCP/IP protocol, the IGS-6325 series can easily integrate with SCADA systems, HMI systems and other data acquisition systems in factory floors. It enables administrators to remotely monitor the industrial Ethernet switch's operating information, port information and communication status, thus easily achieving enhanced monitoring and maintenance of the entire factory.

### Digital Input and Digital Output for External Alarm

The IGS-6325 series helps the network administrators efficiently manage the unexpected network situations by providing Digital Input and Digital Output for external alarm device on the front panel. The Digital Input can be used to detect and log the status of the external devices such as door intrusion detector. The Digital Output could be used to send an alarm whenever the IGS-6325 series has port link-down or power failure.

#### Digital Input

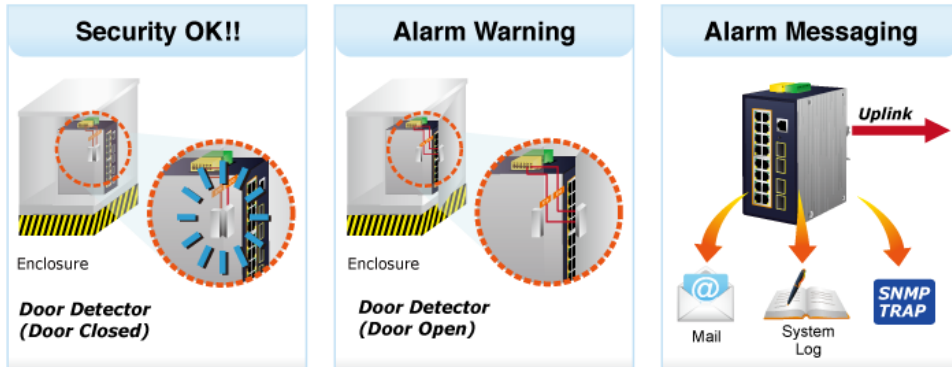

#### Digital Output

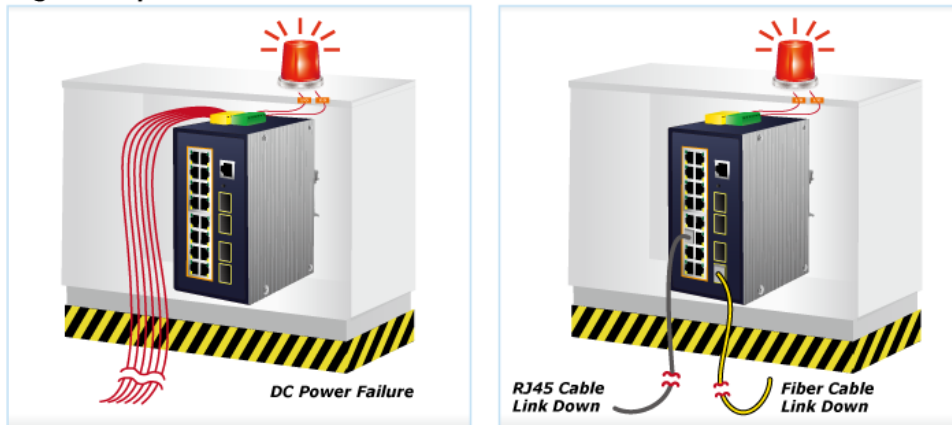

### Effective Alarm Alert for Better Protection

The IGS-6325 series supports a Fault Alarm feature which can alert the users when there is something wrong with the switches. With this ideal feature, the users would not have to waste time to find where the problem is. It will help to save time and human resource.

### Fault Alarm Feature

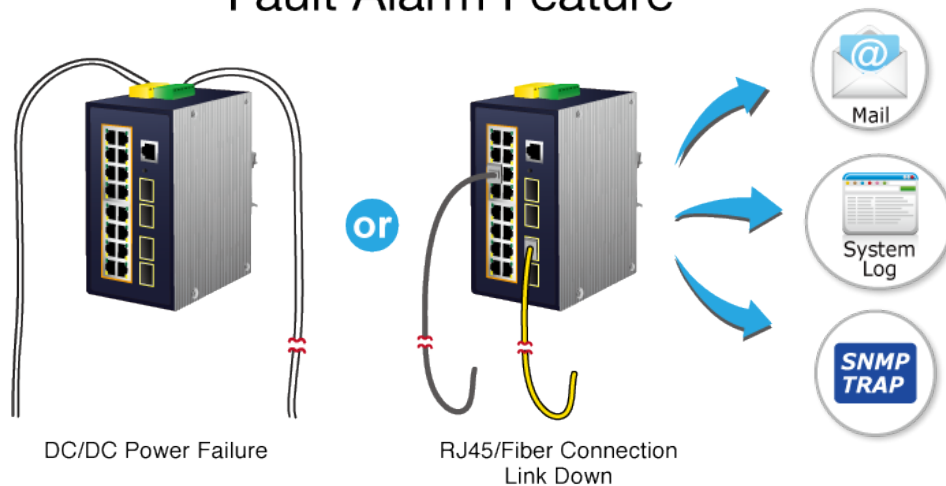

### 1588 Precision Time Protocol for Industrial Computing Networks

The IGS-6325 series is ideal for telecom and carrier Ethernet applications, supporting MEF service delivery and timing over packet solutions for IEEE 1588 and synchronous Ethernet.

## Time Synchronization in Network

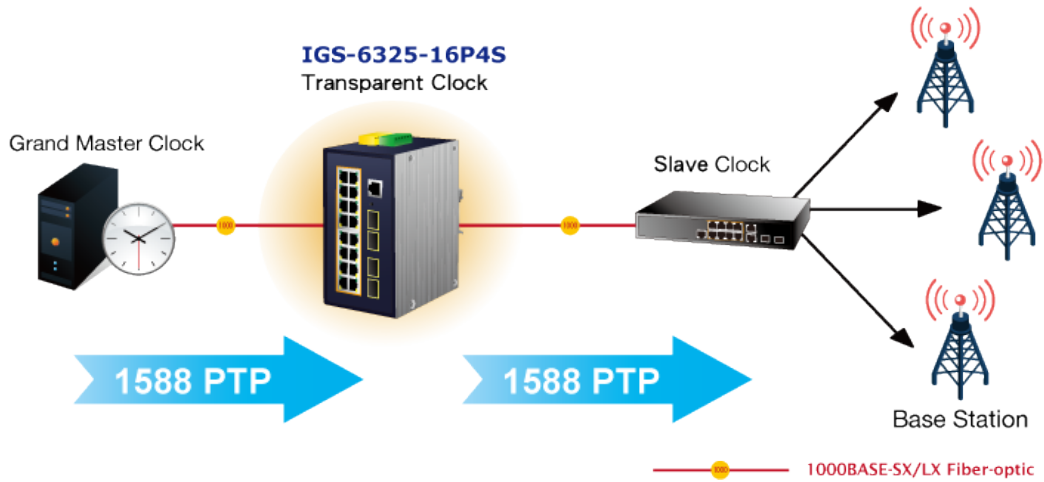

### Redundant Power to Ensure Continuous Operation

The IGS-6325 series comes with dual power input designed utilized as redundant power supply to ensure its continuous operation. Its redundant power system is specifically designed to handle the demands of high-tech facilities requiring the highest power integrity.

### IPv6/IPv4 Dual Stack

Supporting both IPv6 and IPv4 protocols, the IGS-6325 series helps data centers, campuses, telecoms, and more to experience the IPv6 era with the lowest investment as its network facilities need not be replaced or overhauled if the IPv6 FTTx edge network is set up.

### Robust Layer 2 Features

The IGS-6325 series can be programmed for advanced switch management functions such as dynamic port link aggregation, Q-in-Q VLAN, private VLAN, Multiple Spanning Tree Protocol (MSTP), Layer 2 to Layer 4 QoS, bandwidth control and IGMP/MLD Snooping. Via the link aggregation of supporting ports, the IGS-6325 series allows the operation of a high-speed trunk to combine with multiple fiber ports and supports fail-over as well.

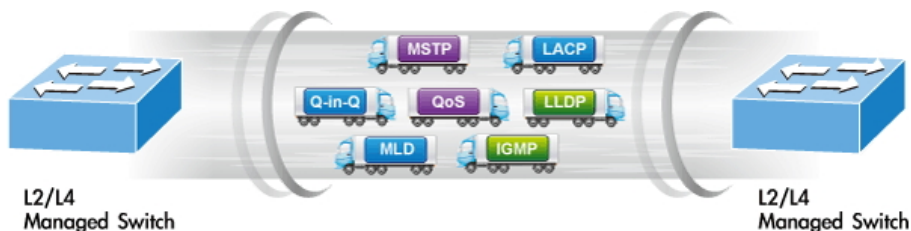

### Powerful Security

The IGS-6325 series offers a comprehensive layer 2 to layer 4 Access Control List (ACL) for enforcing security to the edge. It can be used to restrict network access by denying packets based on source and destination IP address, TCP/UDP ports or defined typical network applications. Its protection mechanism also comprises 802.1X Port-based and MAC-based user, and device authentication. With the private VLAN function, communication between edge ports can be prevented to ensure user

privacy. The IGS-6325 series also provides DHCP Snooping, IP Source Guard and Dynamic ARP Inspection functions to prevent IP snooping from attack and discard ARP packets with invalid MAC address. The network administrators can now construct highly-secure corporate networks with considerably less time and effort than before.

### Excellent Traffic Control

The IGS-6325 series is loaded with powerful traffic management and QoS features to enhance connection services by telecoms and ISPs. The QoS features include wire-speed Layer 4 traffic classifiers and bandwidth limit that are particularly useful for multi-tenant units, multi-business units, Telco and network service providers' applications. It also empowers the industrial environment to take full advantage of the limited network resources and guarantees the best performance in VoIP and video conferencing transmission.

### Flexible and Extendable 10Gb Ethernet Solution

10G Ethernet is a big leap in the evolution of Ethernet. Each of the 10G SFP+ slots in the IGS-6325-8UP2S2X and IGS-6325-8T8S4X support dual speed and 10GBASE-SR/LR or 1000BASE-SX/LX. With up to 4 ports 10G Ethernet link capability and additional Gigabit optic fiber link capability, the administrator now can flexibly choose the suitable SFP/SFP+ transceiver according to the transmission distance or the transmission speed required to extend the network efficiently. The IGS-6325 series provides broad bandwidth and powerful processing capacity.

### Intelligent SFP Diagnosis Mechanism

The IGS-6325 series supports SFP-DDM (Digital Diagnostic Monitor) function that greatly helps network administrator to easily monitor real-time parameters of the SFP, such as optical output power, optical input power, temperature, laser bias current, and transceiver supply voltage.

### Digital Diagnostic Monitor (DDM)



### High Power PoE for Security and Public Service Applications

As the whole system comes with a total 320-watt/360-watt PoE budget, the IGS-6325-16P4S and IGS-6325-8UP2S2X are designed specifically to satisfy the growing demand of higher power consuming network PDs (powered devices) such as multi-channel (802.11a/b/g/n) wireless LAN access points, PTZ (pan, tilt, zoom) speed dome network cameras and other PoE network devices.



### Convenient and Smart ONVIF Devices with Detection Feature

PLANET has newly developed an awesome feature -- ONVIF Support -- which is specifically designed for co-operating with video IP surveillances. From the IGS-6325 PoE models GUI, clients just need one click to search and show all of the ONVIF devices via network application. In addition, clients can upload floor images to the switch series, making the deployments of surveillance and other devices easy for planning and inspection purposes. Moreover, clients can get real-time surveillance's information and online/offline status; the PoE reboot can be controlled from the GUI.



### Intelligent Alive Check for Powered Device

The IGS-6325 PoE models can be configured to monitor connected RJ PD's status in real time via ping action. Once the PD stops working and responding, the IGS-6325 PoE models will recycle the PoE port power and bring the PD back to work. It also greatly enhances the reliability in that the PoE port will reset the PD power, thus reducing administrator's management burden.

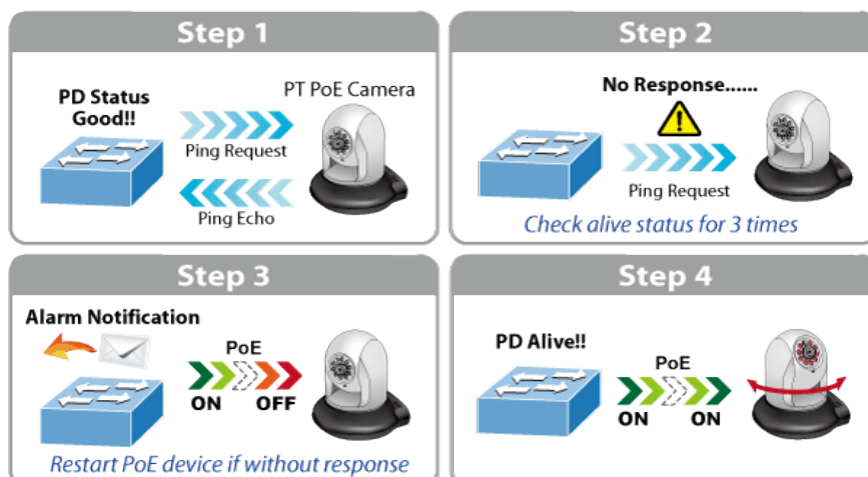

### PoE Schedule for Energy Saving

Under the trend of energy saving worldwide and contributing to environmental protection on the Earth, the IGS-6325 PoE models can effectively control the power supply besides its capability of giving high watts power. The built-in “PoE schedule” function helps you to enable or disable PoE power feeding for each PoE port during specified time intervals and it is a powerful function to help SMBs or enterprises save power and money.

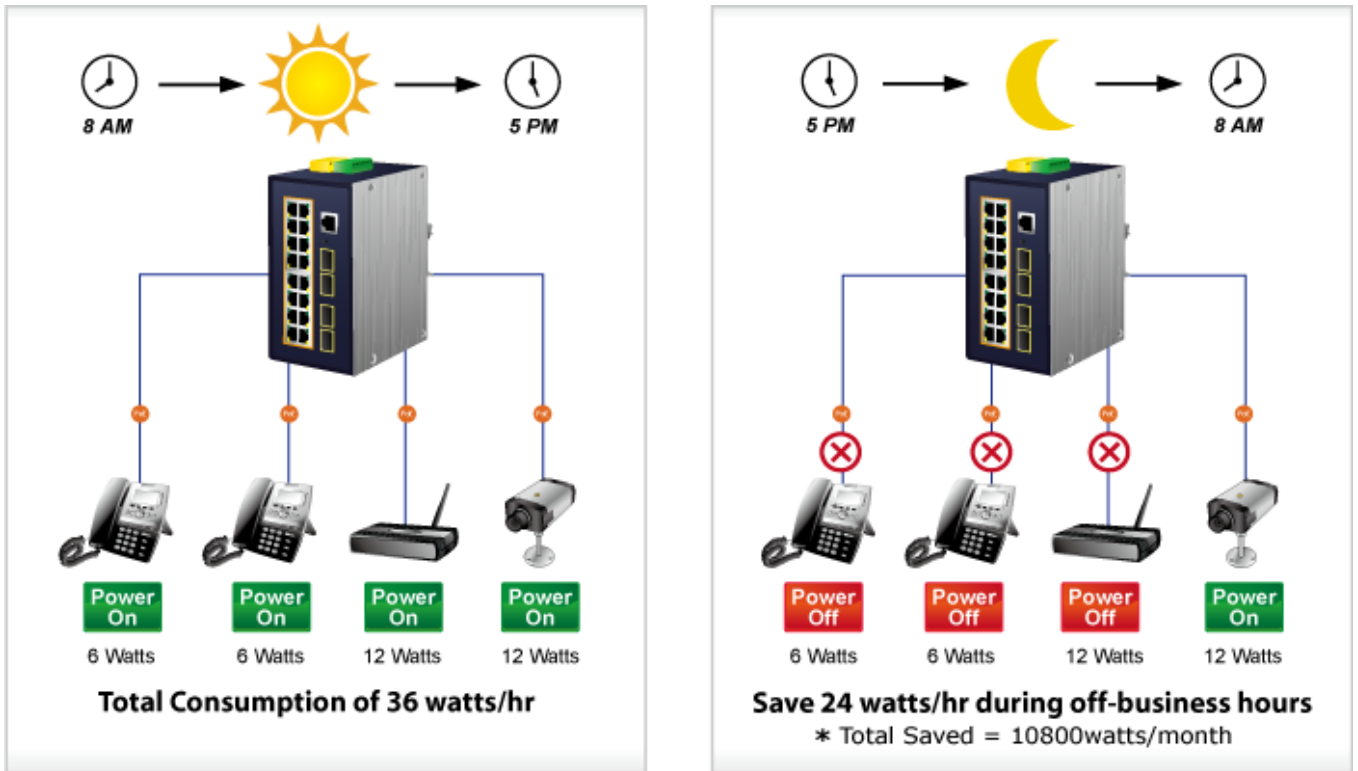

### Scheduled Power Recycling

The IGS-6325 PoE models allows each of the connected PoE IP cameras or PoE wireless access points to reboot at a specific time each week. Therefore, it will reduce the chance of IP camera or AP crash resulting from buffer overflow.

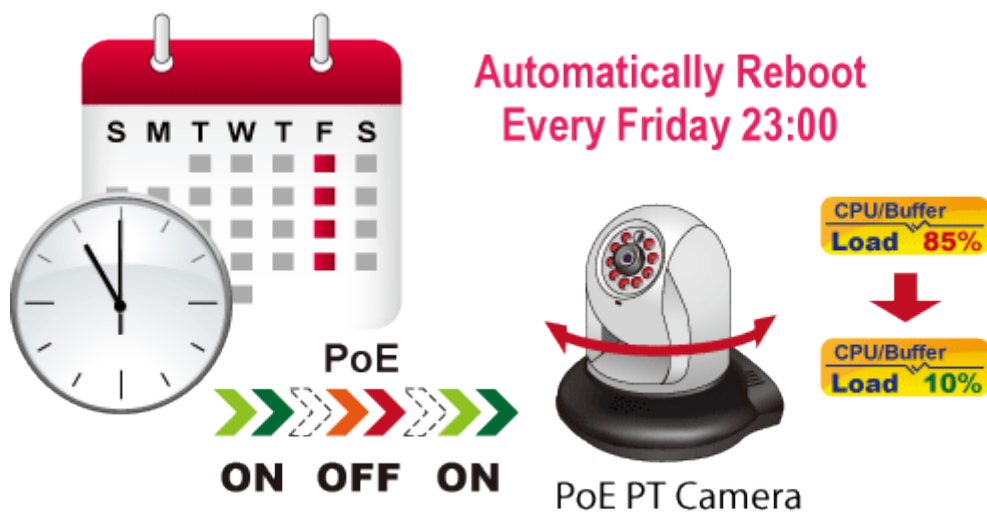



## 1.3 How to Use This Manual

This User's Manual is structured as follows:

### **Section 2, INSTALLATION**

The section explains the functions of the **Industrial Managed Switch** and how to physically install the **Industrial Managed Switch**.

### **Section 3, SWITCH MANAGEMENT**

The section contains the information about the software function of the **Industrial Managed Switch**.

### **Section 4, WEB CONFIGURATION**

The section explains how to manage the **Industrial Managed Switch** by Web interface.

### **Section 5, SWITCH OPERATION**

The chapter explains how to do the switch operation of the **Industrial Managed Switch**.

### **Section 6, TROUBLESHOOTING**

The chapter explains how to do troubleshooting of the **Industrial Managed Switch**.

### **Appendix A**

The section contains cable information of the **Industrial Managed Switch**.

### **Appendix B**

The section contains glossary information of the **Industrial Managed Switch**.

## 1.4 Product Features

### ➤ **Industrial Case and Installation**

- IP30 aluminum case
- DIN-rail or wall-mount design
- Redundant power with polarity reverse protect function
- Supports 6KV DC Ethernet ESD protection
- -40 to 75 degrees C operating temperature

### ➤ **Industrial Protocol**

- Modbus TCP for real-time monitoring in the SCADA system

### ➤ **Digital Input and Digital Output**

- 2 Digital Input (DI)
- 2 Digital Output (DO)
- Integrates sensors into auto alarm system
- Transfers alarm to IP network via email and SNMP trap

### ➤ **Layer 3 IP Routing Features**

- Supports maximum 128 static routes and route summarization
- IPv4 dynamic routing protocol supports OSPFv2
- IPv4/IPv6 hardware static routing
- Routing interface provides per VLAN routing mode

### ➤ **Layer 2 Features**

- High performance of Store-and-Forward architecture, and runt/CRC filtering eliminates erroneous packets to optimize the network bandwidth
- Storm control support
  - Broadcast/Multicast/Unknown unicast
- Supports **VLAN**
  - IEEE 802.1Q tagged VLAN
  - Up to 256 VLANs groups, out of 4096 VLAN IDs
  - Provides Bridging (VLAN Q-in-Q) support (IEEE 802.1ad)
  - Private VLAN Edge (PVE)
  - Protocol-based VLAN
  - MAC-based VLAN
  - IP subnet-based VLAN
  - Voice VLAN
  - GVRP (GARP VLAN Registration Protocol)
- Supports **Spanning Tree Protocol**
  - IEEE 802.1D Spanning Tree Protocol (STP)
  - IEEE 802.1w Rapid Spanning Tree Protocol (RSTP)

- IEEE 802.1s Multiple Spanning Tree Protocol (MSTP), spanning tree by VLAN
- BPDU Guard

- **Supports Link Aggregation**

- 802.3ad Link Aggregation Control Protocol (LACP)
- Cisco ether-channel (static trunk)
- Maximum 14 trunk groups, with 16 ports for each trunk
- Up to 32Gbps bandwidth (full duplex mode)

- Provides port mirror (many-to-1)

- Port mirroring monitors the incoming or outgoing traffic on a particular port

- Loop protection to avoid broadcast loops

- Supports ERPS (Ethernet Ring Protection Switching)

- Compatible with Cisco **Uni-directional link detection** (UDLD) that monitors a link between two switches and blocks the ports on both ends of the link if the link fails at any point between the two devices

- IEEE 1588 and Synchronous Ethernet network timing

- Link Layer Discovery Protocol (LLDP)

➤ **Quality of Service**

- Ingress shaper and egress rate limit per port bandwidth control

- 8 priority queues on all switch ports

- Traffic classification

- IEEE 802.1p CoS
- ToS/DSCP/IP Precedence of IPv4/IPv6 packets
- IP TCP/UDP port number
- Typical network application

- Strict priority and Weighted Round Robin (WRR) CoS policies

- Traffic policing on the switch port

- DSCP remarking

- Voice VLAN

➤ **Multicast**

- Supports IPv4 IGMP snooping v1, v2 and v3

- Supports IPv6 MLD snooping v1 and v2

- Querier mode support

- IPv4 IGMP snooping port filtering

- IPv6 MLD snooping port filtering

- MVR (Multicast VLAN Registration)

➤ **Security**

- Authentication

- IEEE 802.1x port-based/MAC-based network access authentication
- IEEE 802.1x authentication with guest VLAN

- Built-in RADIUS client to cooperate with the RADIUS servers
- RADIUS/TACACS+ users access authentication

■ Access Control List

- IP-based Access Control List (ACL)
- MAC-based Access Control List (ACL)

■ Source MAC/IP address binding

■ **DHCP Snooping** to filter distrusted DHCP messages

■ **Dynamic ARP Inspection** discards ARP packets with invalid MAC address to IP address binding

■ **IP Source Guard** prevents IP spoofing attacks

■ IP address access management to prevent unauthorized intruder

➤ **Management**

■ IPv4 and IPv6 dual stack management

■ Switch Management Interfaces

- Console/Telnet command line interface
- Web switch management
- SNMP v1, v2c, and v3 switch management
- SSH/SSL secure access

■ IPv6 address/NTP management

■ Built-in Trivial File Transfer Protocol (TFTP) client

■ BOOTP and DHCP for IP address assignment

■ System Maintenance

- Firmware upload/download via HTTP/TFTP
- Reset button for system reboot or reset to factory default
- Dual images

■ DHCP relay and option 82

■ DHCP Server

■ User privilege levels control

■ NTP (Network Time Protocol)

■ Link Layer Discovery Protocol (LLDP) and LLDP-MED

■ Network diagnostic

- SFP-DDM (Digital Diagnostic Monitor)
- Cable diagnostic technology provides the mechanism to detect and report potential cabling issues
- ICMPv6/ICMPv4 remote ping

■ SMTP/Syslog remote alarm

■ Four RMON groups (history, statistics, alarms and events)

■ SNMP trap for interface link up and link down notification

■ System Log

■ PLANET Smart Discovery Utility for deployment management

➤ **Power over Ethernet**

**IGS-6325-16P4S, IGS-6325-8UP2S and IGS-6325-8UP2S2X**

- Auto detects powered device (PD)
- Circuit protection prevents power interference between ports
- Remote power feeding up to 100m
- PoE management features
  - Total PoE power budget control
  - Per port PoE function enable/disable
  - PoE admin-mode control
  - PoE port power feeding priority
  - Per PoE port power limit
  - PD classification detection
- Intelligent PoE features
  - Temperature threshold control
  - PoE usage threshold control
  - PD alive check
  - PoE schedule

## 1.5 Product Specifications

### ■ IGS-6325 PoE Models

Product	IGS-6325-16P4S	IGS-6325-8UP2S	IGS-6325-8UP2S2X
<b>Hardware Specifications</b>			
<b>Copper Ports</b>	16 10/100/1000BASE-T RJ45 auto-MDI/MDI-X ports	8 10/100/1000BASE-T RJ45 auto-MDI/MDI-X ports	
<b>SFP Slots</b>	4 1000BASE-SX/LX/BX SFP interfaces Compatible with 100BASE-FX SFP	2 1000BASE-SX/LX/BX SFP interfaces Compatible with 100BASE-FX SFP	
<b>10G SFP+ Slots</b>	--	--	4 10GbBASE-SR/LR SFP+ interfaces Compatible with 1000BASE-SX/LX/BX SFP transceiver
<b>PoE Injector Port</b>	16 ports with 802.3at/af PoE+ PSE	8 ports with 802.3bt PoE++ PSE	
<b>Console</b>	1 x RJ45-to-RS232 serial port (115200, 8, N, 1)		
<b>Switch Architecture</b>	Store-and-Forward		
<b>Switch Fabric</b>	40Gbps/non-blocking	20Gbps/non-blocking	60Gbps/non-blocking
<b>Throughput (packet per second)</b>	29.7Mpps@ 64 bytes packet	14.8Mpps@ 64 bytes packet	44.64Mpps@ 64 bytes packet
<b>Address Table</b>	16K entries, automatic source address learning and aging		
<b>Shared Data Buffer</b>	32Mbits		
<b>Flow Control</b>	IEEE 802.3x pause frame for full-duplex Back pressure for half-duplex		
<b>Jumbo Frame</b>	10K bytes		
<b>Reset Button</b>	< 5 sec: System reboot > 5 sec: Factory default		
<b>ESD Protection</b>	6KV DC		
<b>Enclosure</b>	IP30 aluminum case		
<b>Installation</b>	DIN-rail kit and wall-mount kit		
<b>Connector</b>	Removable 6-pin terminal block for power input Pin 1/2 for Power 1, Pin 3/4 for fault alarm, Pin 5/6 for Power 2 Removable 6-pin terminal block for DI/DO interface Pin 1/2 for DI 1 & 2, Pin 3/4 for DO 1 & 2, Pin 5/6 for GND		
<b>Alarm</b>	One relay output for power failure. Alarm relay current carry ability: 1A @ 24V DC		
<b>Digital Input (DI)</b>	2 digital input: Level 0: -24~2.1V (±0.1V) Level 1: 2.1~24V (±0.1V) Input load to 24V DC, 10mA max.		
<b>Digital Output (DO)</b>	2 digital output: Open collector to 24VDC, 100mA		

<b>Digital Output</b>		2 Digital Output (DO) Open collector to 24V DC, 100mA max.		
<b>Dimensions (W x D x H)</b>		84 x 107 x 152 mm		76 x 107 x 152 mm
<b>Weight</b>		1550g		1138g      1152g
<b>Power Requirements</b>		48~56V DC (>51V DC for PoE+ output recommended)		Dual DC 48~56V, 7A max. (>52V DC for 802.3bt PoE++ output recommended)
<b>Power Consumption</b>	<b>System on</b>	Max. 12.1 watts		Max. 27 watts      Max. 29 watts
	<b>Full loading</b>	Max. 350 watts		Max. 395 watts      Max. 401 watts
<b>Power Over Ethernet</b>				
<b>PoE Standard</b>		IEEE 802.3at Power over Ethernet Plus/PSE		IEEE 802.3bt PoE++ Type-4 /PSE
<b>PoE Power Supply Type</b>		End-span		End-span + Mid-span End-span Mid-span
<b>Power Pin Assignment</b>		1/2(+), 3/6(-)		1/2(-), 3/6(+), 4/5(+), 7/8(-)
<b>PoE Power Output</b>	<b>IEEE 802.3af</b>	Per port 48V~51V DC (depending on the power supply), max. 15.4 watts		--
	<b>IEEE 802.3at</b>	Per port 51V~56V DC (depending on the power supply), max. 36 watts		Per port 51V~56V DC (depending on the power supply), max. 36 watts
	<b>IEEE 802.3bt</b>	--		Per port 51V~56V DC (depending on the power supply), max. 95 watts
<b>PoE Power Budget</b>	<b>48V DC input</b>	- 240W maximum		--
	<b>52~56V DC input</b>	- Single power input: 240W maximum - Dual power input: 320W maximum		- Single power input: 240W maximum - Dual power input: 360W maximum
<b>Max. number of Class 3 PDs</b>		16		8
<b>Max. number of Class 4 PDs</b>		10		8
<b>Max. number of bt Type-3 PDs</b>		--		6
<b>Max. number of bt Type-4 PDs</b>		--		4
<b>PoE Management Functions</b>				
<b>PoE Extend Mode</b>		-- (next firmware version)		Yes, max. 160 to 200 meters
<b>Active PoE device alive detects</b>		Yes		
<b>PoE Power Recycle</b>		Yes, daily or predefined schedule		
<b>PoE Schedule</b>		4 schedule profiles		
<b>PoE System Management</b>		System PoE Admin control Total PoE power budget control Auto power input and PoE budget control PoE Legacy mode Over-temperature threshold alarm PoE usage threshold alarm		
<b>PoE Port Management</b>		Port Enable/Disable/Schedule		Port Enable/Disable/Schedule PoE mode control



	PoE mode control - 802.3at - 802.3af Port Priority Power Allocation	- 802.3bt - UPoE - 802.3at End-span - 802.3at Mid-span Force mode Port Priority
<b>Layer 2 Functions</b>		
<b>Port Configuration</b>	Port disable/enable Auto-negotiation 10/100/1000Mbps full and half duplex mode selection Flow control disable/enable Power saving mode control	
<b>Port Status</b>	Display each port's speed duplex mode, link status, flow control status, auto negotiation status, trunk status	
<b>Port Mirroring</b>	TX / RX / Both Many-to-1 monitor	
<b>VLAN</b>	IEEE 802.1Q tag-based VLAN, up to 255 VLAN groups IEEE 802.1ad Q-in-Q tunneling Private VLAN Edge (PVE) MAC-based VLAN Protocol-based VLAN Voice VLAN MVR (Multicast VLAN Registration) GVRP (GARP VLAN Registration Protocol) Up to 255 VLAN groups, out of 4094 VLAN IDs	
<b>Link Aggregation</b>	IEEE 802.3ad LACP/static trunk Supports 10 trunk groups with 4 ports per trunk group	
<b>Spanning Tree Protocol</b>	IEEE 802.1D Spanning Tree Protocol IEEE 802.1w Rapid Spanning Tree Protocol IEEE 802.1s Multiple Spanning Tree Protocol	
<b>QoS</b>	Traffic classification based, strict priority and WRR 8-level priority for switching - Port number - 802.1p priority - 802.1Q VLAN tag - DSCP/TOS field in IP packet	
<b>IGMP Snooping</b>	IPv4 IGMP (v1/v2/v3) snooping, up to 255 multicast groups IPv4 IGMP querier mode support	
<b>MLD Snooping</b>	IPv6 MLD (v1/v2) snooping, up to 255 multicast groups IPv6 MLD querier mode support	
<b>Access Control List</b>	IP-based ACL/MAC-based ACL Up to 123 entries	
<b>Bandwidth Control</b>	Per port bandwidth control Ingress: 500Kb~1000Mbps Egress: 500Kb~1000Mbps	
<b>Layer 3 Functions</b>		
<b>IP Interfaces</b>	Max. 128 VLAN interfaces	
<b>Routing Table</b>	Max. 128 routing entries	
<b>Routing Protocols</b>	IPv4 software static routing IPv6 software static routing	

	IPv4 OSPFv2 dynamic routing
<b>Management</b>	
<b>Basic Management Interfaces</b>	Console; Telnet; Web browser; SNMP v1, v2c
<b>Secure Management Interfaces</b>	SSHv1/SSHv2, TLS v1.1/v1.2, SSL, SNMP v3
<b>SNMP MIBs</b>	RFC 1213 MIB-II IF-MIB RFC 1493 Bridge MIB RFC 1643 Ethernet MIB RFC 2863 Interface MIB RFC 2665 Ether-Like MIB RFC 2819 RMON MIB (Groups 1, 2, 3 and 9) RFC 2737 Entity MIB RFC 2618 RADIUS Client MIB RFC 2933 IGMP-STD-MIB RFC 3411 SNMP-Frameworks-MIB IEEE 802.1X PAE LLDP MAU-MIB
<b>Standards Conformance</b>	
<b>Regulatory Compliance</b>	FCC Part 15 Class A CE: EN55032 EN55035
<b>Stability Testing</b>	IEC60068-2-32 (free fall) IEC60068-2-27 (shock) IEC60068-2-6 (vibration)
<b>Standards Compliance</b>	IEEE 802.3 10BASE-T IEEE 802.3u 100BASE-TX/100BASE-FX IEEE 802.3z Gigabit SX/LX IEEE 802.3ab Gigabit 1000T IEEE 802.3ae 10Gb/s Ethernet (IGS-6325-8UP2S2X) IEEE 802.3x flow control and back pressure IEEE 802.3ad port trunk with LACP IEEE 802.1D Spanning Tree Protocol IEEE 802.1w Rapid Spanning Tree Protocol IEEE 802.1s Multiple Spanning Tree Protocol IEEE 802.1p Class of Service IEEE 802.1Q VLAN tagging IEEE 802.1X Port Authentication Network Control IEEE 802.1ab LLDP IEEE 802.3af Power over Ethernet IEEE 802.3at Power over Ethernet Plus IEEE 802.3bt Power over Ethernet Plus Plus (IGS-6325-8UP2S/IGS-6325-8UP2S2X) IEEE 802.3ah OAM IEEE 802.1ag Connectivity Fault Management (CFM) RFC 768 UDP RFC 793 TFTP RFC 791 IP RFC 792 ICMP

	RFC 2068 HTTP RFC 1112 IGMP v1 RFC 2236 IGMP v2 RFC 3376 IGMP v3 RFC 2710 MLD v1 FRC 3810 MLD v2 RFC 2328 OSPF v2 ITU-T G.8032 ERPS Ring ITU-T Y.1731 Performance Monitoring
<b>Environment</b>	
<b>Operating Temperature</b>	-40 ~ 75 degrees C
<b>Storage Temperature</b>	-40 ~ 85 degrees C
<b>Humidity</b>	5 ~ 95% (non-condensing)

■ IGS-6325 Non-PoE Models

Product	IGS-6325-8T8S	IGS-6325-8T8S4X	IGS-6325-8T4X
<b>Hardware Specifications</b>			
Copper Ports	8 10/100/1000BASE-T RJ45 auto-MDI/MDI-X ports		
SFP Ports	8 100/1000BASE-X SFP slot interfaces (Port-9 to Port-16) Compatible with 100BASE-FX SFP transceiver		--
SFP+ Ports	--	4 10GbBASE-SR/LR SFP+ slot interfaces Compatible with 1000BASE-SX/LX/BX SFP transceiver	
Console	1 x RJ45-to-RS232 serial port (115200, 8, N, 1)		
Switch Architecture	Store-and-Forward		
Switch Fabric	32Gbps/non-blocking	112Gbps/non-blocking	96Gbps/non-blocking
Throughput	23.81Mpps@64Bytes	83.33Mpps@64Bytes	71.43Mpps@64Bytes
Address Table	16K entries, automatic source address learning and aging		
Shared Data Buffer	32Mbits		
Jumbo Frame	10K bytes		
SDRAM	512Mbytes		
Flash Memory	64Mbytes		
Flow Control	IEEE 802.3x pause frame for full duplex Back pressure for half duplex		
Reset Button	< 5 sec: System reboot > 5 sec: Factory default		
Connector	Removable 6-pin terminal block for power input Pin 1/2 for Power 1, Pin 3/4 for fault alarm, Pin 5/6 for Power 2 Removable 6-pin terminal block for DI/DO interface Pin 1/2 for DI 1 & 2, Pin 3/4 for DO 1 & 2, Pin 5/6 for GND		
Alarm	One relay output for power failure. Alarm relay current carry ability: 1A @ 24V DC		
Digital Input (DI)	2 digital input: Level 0: -24~2.1V ( $\pm 0.1V$ ) Level 1: 2.1~24V ( $\pm 0.1V$ ) Input load to 24V DC, 10mA max.		
Digital Output (DO)	2 digital output: Open collector to 24VDC, 100mA		
Enclosure	IP30 aluminum case		
Installation	DIN-rail or wall mounting		
Dimensions (W x D x H)	76 x 107 x 152 mm		
Weight	1,065g	1,250g	1,020g
Power Requirements	DC 12~48V, 4A max.		
	AC 24V, 1.5A max.		
Power Consumption	DC input: Max. 9.12 watts/32BTU	DC input: Max. 12 watts/41BTU	DC input: Max. 10 watts/35BTU

	(system on) Max. 37.68 watts/129 BTU (Full loading)	(system on) Max. 43.44 watts/148.2 BTU (Full loading, RJ45-SFP)	(system on) Max. 39 watts/133 BTU (Full loading)
	AC 24V input: Max. 12 watts/41BTU (system on) Max. 35.24 watts/120BTU (Full loading)	AC 24V input: Max. 13 watts/45BTU (system on) Max. 41 watts/140BTU (Full loading)	AC 24V input: Max. 12 watts/41BTU (system on) Max. 37 watts/126BTU (Full loading)
<b>ESD Protection</b>	6KV DC		
<b>Surge Protection</b>	4KV DC		
<b>LED Indicators</b>	<p><b>System:</b></p> <ul style="list-style-type: none"> <li>Power 1 (Green), Power 2 (Green)</li> <li>Fault Alarm (Red)</li> <li>Ring (Green), Ring Owner (Green)</li> <li>DIDO (Red)</li> </ul> <p><b>Per 10/100/1000T RJ45 Port:</b></p> <ul style="list-style-type: none"> <li>1000Mbps LNK/ACT (Green)</li> <li>10/100Mbps LNK/ACT (Amber)</li> </ul> <p><b>Per SFP Port:</b></p> <ul style="list-style-type: none"> <li>1000Mbps LNK/ACT (Green)</li> <li>100Mbps LNK/ACT (Amber)</li> </ul> <p><b>Per SFP+ Port:</b></p> <ul style="list-style-type: none"> <li>10Gbps LNK/ACT (Green)</li> <li>1Gbps LNK/ACT (Amber)</li> </ul>		
<b>Layer 2 Management Functions</b>			
<b>Port Configuration</b>	<ul style="list-style-type: none"> <li>Port disable/enable</li> <li>Auto-negotiation 10/100/1000Mbps full and half duplex mode selection</li> <li>Flow control disable/enable</li> <li>Port link capability control</li> </ul>		
<b>Port Status</b>	Display each port's speed duplex mode, link status, flow control status, auto-negotiation status, trunk status		
<b>Port Mirroring</b>	<ul style="list-style-type: none"> <li>TX/RX/Both</li> <li>Many-to-1 monitor</li> </ul>		
<b>VLAN</b>	<ul style="list-style-type: none"> <li>802.1Q tagged VLAN</li> <li>Q-in-Q tunneling</li> <li>Private VLAN Edge (PVE)</li> <li>MAC-based VLAN</li> <li>Protocol-based VLAN</li> <li>Voice VLAN</li> <li>IP Subnet-based VLAN</li> <li>MVR (Multicast VLAN registration)</li> <li>GVRP</li> <li>Up to 256 VLAN groups, out of 4095 VLAN IDs</li> </ul>		
<b>Link Aggregation</b>	IEEE 802.3ad LACP/static trunk		

	14 trunk groups with 16 port per trunk group
<b>Spanning Tree Protocol</b>	IEEE 802.1D Spanning Tree Protocol IEEE 802.1w Rapid Spanning Tree Protocol IEEE 802.1s Multiple Spanning Tree Protocol
<b>IGMP Snooping</b>	IPv4 IGMP (v1/v2/v3) snooping IPv4 IGMP querier mode support Supports 255 IGMP groups
<b>MLD Snooping</b>	IPv6 MLD (v1/v2) snooping, IPv6 MLD querier mode support Supports 255 MLD groups
<b>Access Control List</b>	IP-based ACL/MAC-based ACL ACL based on: <ul style="list-style-type: none"> <li>- MAC Address</li> <li>- IP Address</li> <li>- Ethertype</li> <li>- Protocol Type</li> <li>- VLAN ID</li> <li>- DSCP</li> <li>- 802.1p Priority</li> </ul> Up to 256 entries
<b>Bandwidth Control</b>	Per port bandwidth control Ingress: 100Kbps~1000Mbps Egress: 100Kbps~1000Mbps
<b>QoS</b>	Traffic classification based, strict priority and WRR 8-level priority for switching: <ul style="list-style-type: none"> <li>- Port number</li> <li>- 802.1p priority</li> <li>- 802.1Q VLAN tag</li> <li>- DSCP/ToS field in IP packet</li> </ul>
<b>Synchronization</b>	IEEE 1588v2 PTP(Precision Time Protocol) <ul style="list-style-type: none"> <li>- Peer-to-peer transparent clock</li> <li>- End-to-end transparent clock</li> </ul>
<b>Layer 3 Functions</b>	
<b>IP Interfaces</b>	Max. 128 VLAN interfaces
<b>Routing Table</b>	Max. 128 routing entries
<b>Routing Protocols</b>	OSPFv2 dynamic routing IPv4 hardware static routing IPv6 hardware static routing
<b>Management</b>	
<b>Basic Management Interfaces</b>	Console; Telnet; Web browser; SNMP v1, v2c
<b>Secure Management Interfaces</b>	SSHv1/v2, TLS v1.1/v1.2, SSL, SNMPv3
<b>System Management</b>	Firmware upgrade by HTTP protocol through Ethernet network Configuration upload/download through HTTP

	<p>Remote Syslog System log LLDP protocol NTP PLANET Smart Discovery Utility</p>
<b>SNMP MIBs</b>	<p>RFC 1213 MIB-II RFC 1493 Bridge MIB RFC 1643 Ethernet MIB RFC 2863 Interface MIB RFC 2665 Ether-Like MIB RFC 2819 RMON MIB (Group 1, 2, 3 and 9) RFC 2737 Entity MIB RFC 2618 RADIUS Client MIB RFC 2863 IF-MIB RFC 2933 IGMP-STD-MIB RFC 3411 SNMP-Frameworks-MIB RFC 4292 IP Forward MIB RFC 4293 IP MIB RFC 4836 MAU-MIB IEEE 802.1X PAE LLDP</p>
<b>Standards Conformance</b>	
<b>Regulatory Compliance</b>	<p>FCC Part 15 Class A CE: EN55032 EN55035</p>
<b>Stability Testing</b>	<p>IEC60068-2-32 (free fall) IEC60068-2-27 (shock) IEC60068-2-6 (vibration)</p>
<b>Standards Compliance</b>	<p>IEEE 802.3 10BASE-T IEEE 802.3u 100BASE-TX/100BASE-FX IEEE 802.3z Gigabit SX/LX IEEE 802.3ab Gigabit 1000T IEEE 802.3ae 10Gb/s Ethernet IEEE 802.3x flow control and back pressure IEEE 802.3ad port trunk with LACP IEEE 802.1D Spanning Tree Protocol IEEE 802.1w Rapid Spanning Tree Protocol IEEE 802.1s Multiple Spanning Tree Protocol IEEE 802.1p Class of Service IEEE 802.1Q VLAN tagging IEEE 802.1X Port Authentication Network Control IEEE 802.1ab LLDP IEEE 802.3ah OAM</p>



	<p>IEEE 802.1ag Connectivity Fault Management (CFM)  RFC 768 UDP  RFC 793 TFTP  RFC 791 IP  RFC 792 ICMP  RFC 2068 HTTP  RFC 1112 IGMP v1  RFC 2236 IGMP v2  RFC 3376 IGMP v3  RFC 2710 MLD v1  RFC 3810 MLD v2  RFC 2328 OSPF v2  ITU-T G.8032 ERPS Ring  ITU-T Y.1731 Performance Monitoring</p>
<b>Environment</b>	
<b>Operating</b>	-40 ~ 75 degrees C
<b>Storage</b>	-40 ~ 85 degrees C
<b>Humidity</b>	5 ~ 95% (non-condensing)

## 2. INSTALLATION

### 2.1 Hardware Description

The Industrial Managed Switch provides three different running speeds – 10Mbps, 100Mbps or 1000Mbps and automatically distinguishes the speed of incoming connection.

This section describes the hardware features of Industrial Managed Switch. For easier management and control of the Industrial Managed Switch, familiarize yourself with its display indicators and ports. Front panel illustrations in this chapter display the unit LED indicators. Before connecting any network device to the Industrial Managed Switch, read this chapter carefully.

Model Name Item	IGS-6325-16P4S	IGS-6325-8UP2S	IGS-6325-8UP2S2X	IGS-6325-8T8S4X	IGS-6325-8T4X	IGS-6325-8T8S
10/100/1000BASE-T Copper	16	8	8	8	8	8
100/1000BASE-X SFP	4	2	2	8	--	8
10GBASE-SR/LR SFP+	--	--	2	4	4	--
Power over Ethernet Standard	IEEE 802.3at PoE+	IEEE 802.3bt PoE++	IEEE 802.3bt PoE++	--	--	--
PoE Ports	16	8	8	--	--	--
PoE Budget	320 watts	360 watts	360 watts	--	--	--
Power Input	48-56V DC x 2	52~56V DC x 2		12~48V DC x 2 or 24V AC		

## 2.1.1 Physical Dimensions

### IGS-6325-16P4S

Dimensions (W x D x H) : 84 x 107 x 152mm

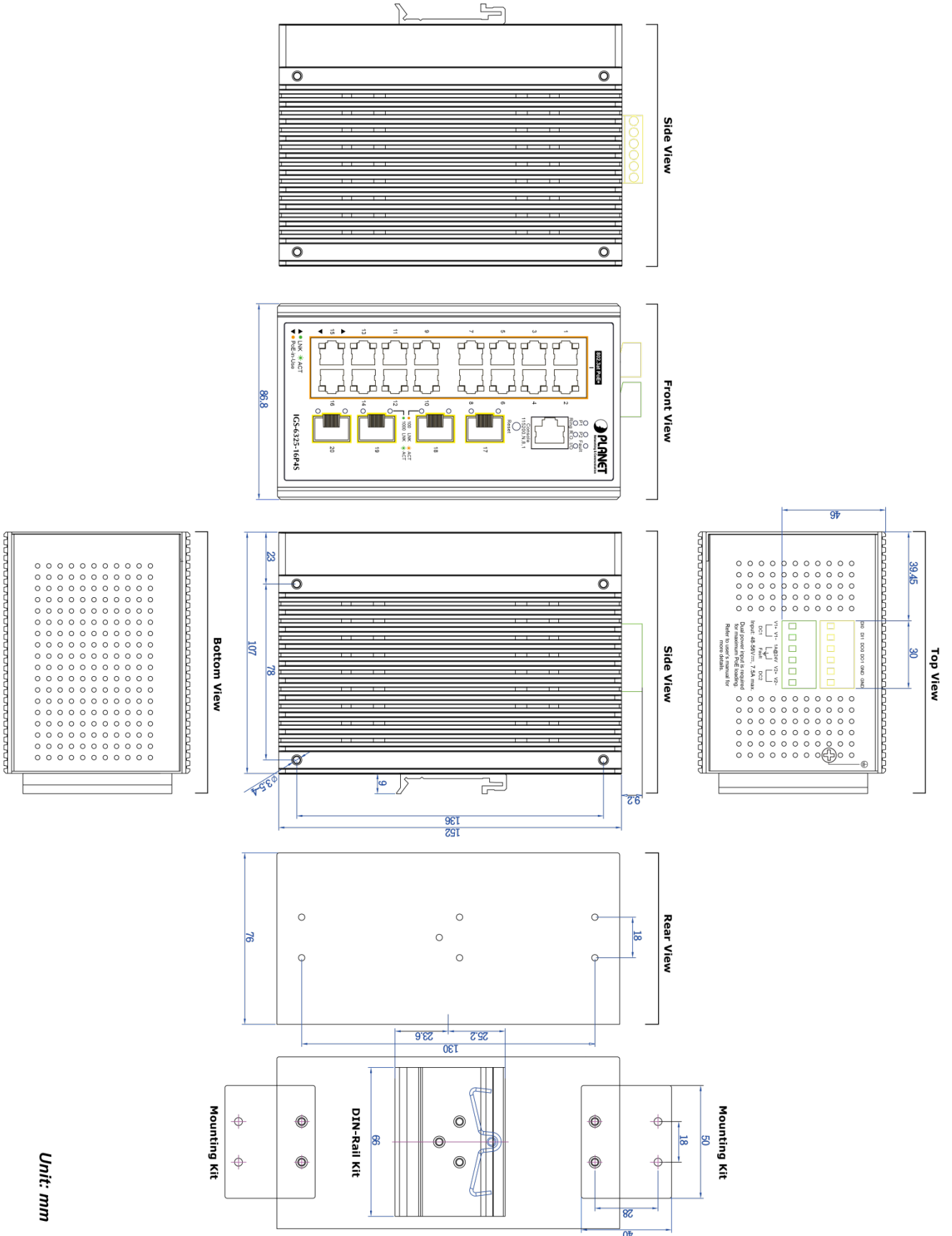

Unit: mm

## 2.1.2 Front Panel

The front panel provides a simple interface monitoring the Industrial Managed Switch. [Figure 2-1-1](#) and [Figure 2-1-3](#) show the front panels of the Industrial Managed Switches.

### IGS-6325-16P4S

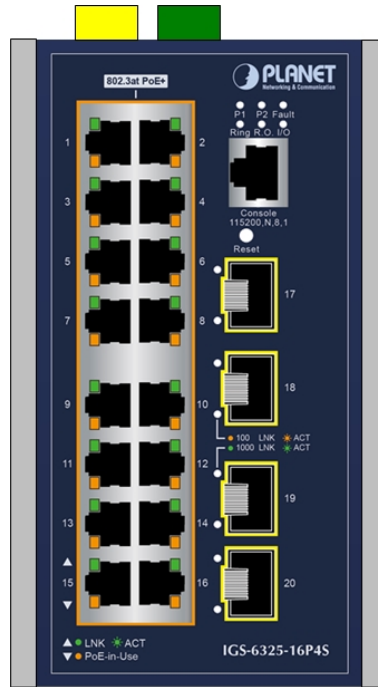

Figure 2-1-1 IGS-6325-16P4S Switch Front Panel

### IGS-6325-8UP2S and IGS-6325-8UP2S2X

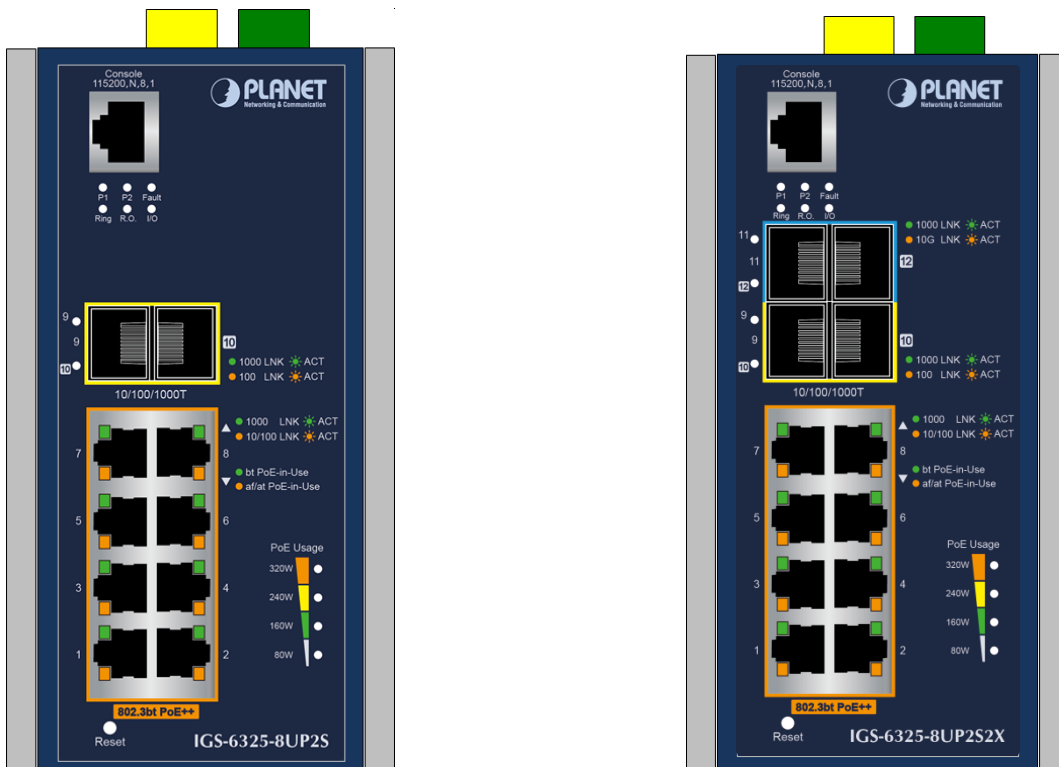

Figure 2-1-2 IGS-6325-8UP2S and IGS-6325-8UP2S2X Switch Front Panels

**IGS-6325-8T8S** and **IGS-6325-8T8S4X**

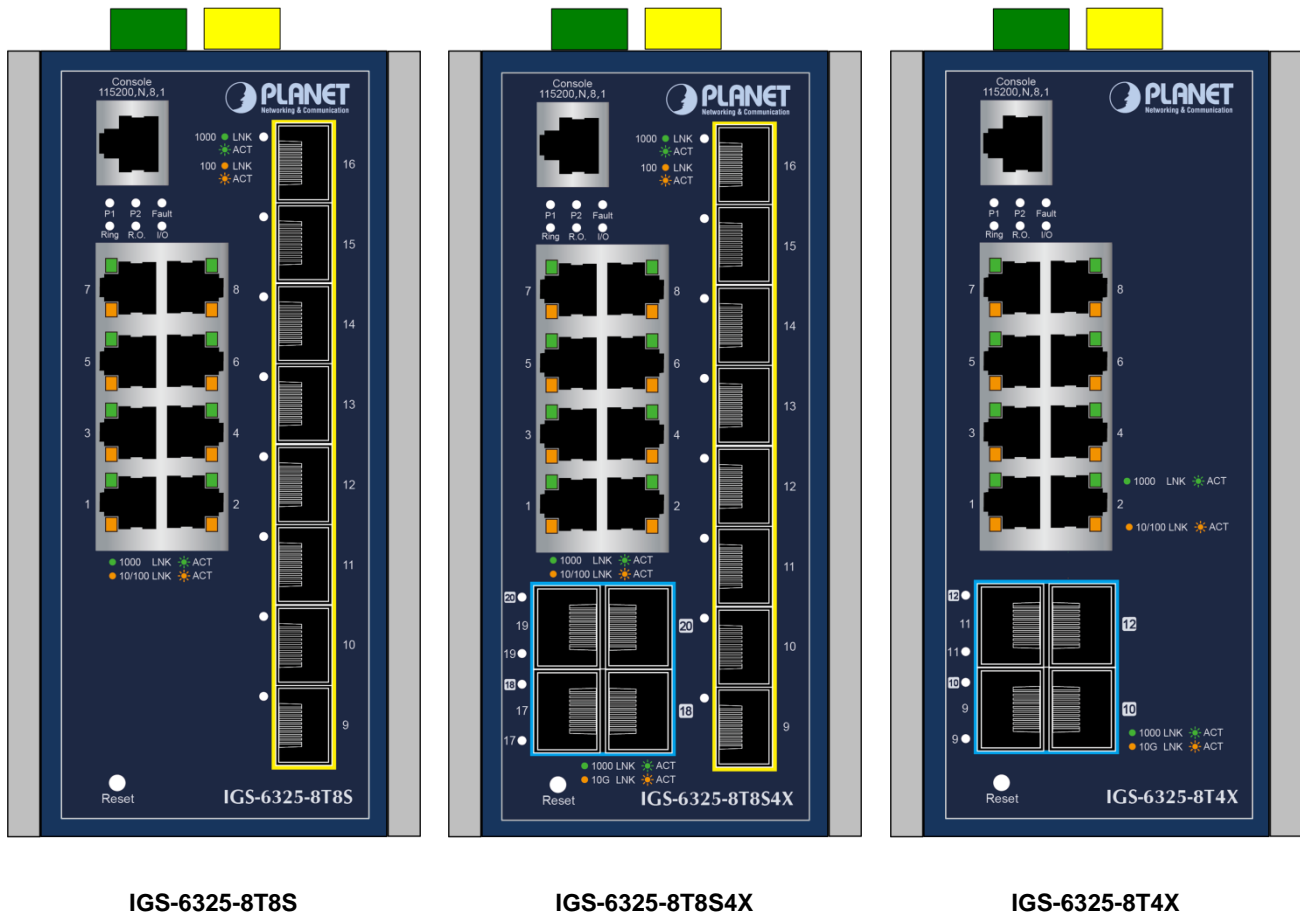

Figure 2-1-3 IGS-6325-8T8S and IGS-6325-8T8S4X Switch Front Panels

■ **Gigabit TP Interface**

10/100/1000BASE-T Copper, RJ45 twisted-pair: Up to 100 meters.

■ **SFP Slot**

100/1000BASE-X mini-GBIC slot, SFP (Small-form Factor Pluggable) transceiver module: From 550 meters to 2km (multi-mode fiber) and to 10/20/30/40/50/70/120 kilometers (single-mode fiber).

■ **10 Gigabit SFP+ Slot**

10GBASE-SR/LR mini-GBIC slot, SFP+ (Small Factor Pluggable Plus) transceiver module supports a distance from 300 meters (multi-mode fiber) to up to 10 kilometers (single mode fiber).

■ **Console Port**

The console port is an RJ45 port connector. It is an interface for connecting a terminal directly. Through the console port, it provides rich diagnostic information including IP address setting, factory reset, port management, link status and system setting. Users can use the attached DB9 to RJ45 console cable in the package and connect to the console port on the device. After the connection, users can run any terminal emulation program (Hyper Terminal, ProComm Plus, Telix,

Wintem and so on) to enter the startup screen of the device.

### Reset Button

On the upper left side of the front panel, the reset button is designed for rebooting the Industrial Managed Switch without turning off and on the power. The following is the summary table of reset button functions:

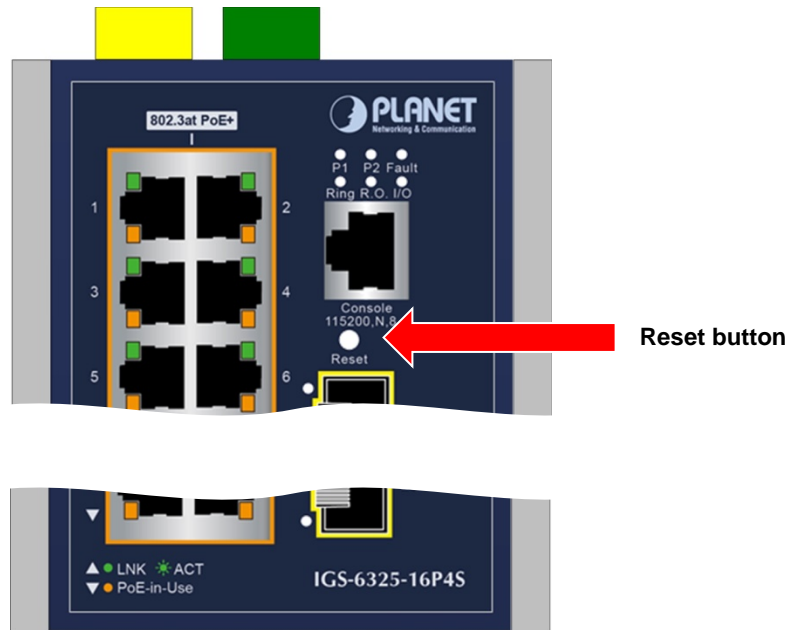

Figure 2-1-4: Reset Button of IGS-6325-16P4S

Reset Button Pressed and Released	Function
< 5 sec: System Reboot	Reboot the Industrial Managed Switch.
> 5 sec: Factory Default	Reset the Industrial Managed Switch to Factory Default configuration. The Industrial Managed Switch will then reboot and load the default settings as shown below: <ul style="list-style-type: none"> <li>◦ Default Username: <b>admin</b></li> <li>◦ Default Password: <b>admin</b></li> <li>◦ Default IP Address: <b>192.168.0.100</b></li> <li>◦ Subnet Mask: <b>255.255.255.0</b></li> <li>◦ Default Gateway: <b>192.168.0.254</b></li> </ul>

### 2.1.3 LED Indications

The front panel LEDs indicate instant statuses of power and ring, R.O., DI/DO and fault; they help monitor and troubleshoot when needed. Figures 2-1-5 and 2-1-9 show the LED indications of the Industrial Managed Switch.

#### IGS-6325-16P4S

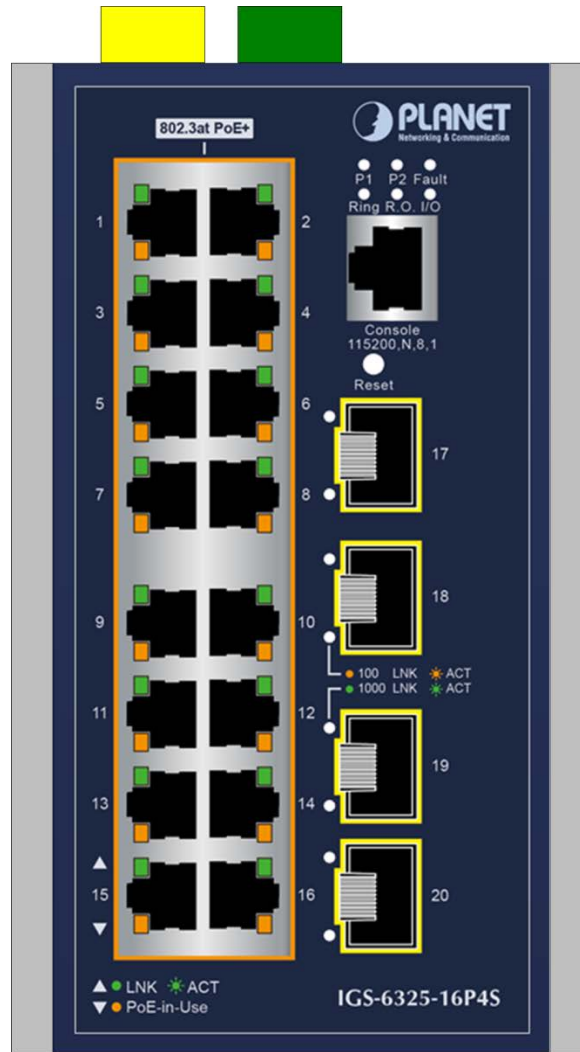

Figure 2-1-5: IGS-6325-16P4S LEDs on Front Panel

#### ■ System

LED	Color	Function
DC1	Green	Lights to indicate DC power input 1 has power.
DC2	Green	Lights to indicate DC power input 2 has power.
Fault	Red	Lights to indicate that Switch DC or port has failed.
Ring	Green	Lights to indicate that the ERPS Ring has been created successfully.
R.O.	Green	Lights to indicate that Ring state is in idle mode.
		Blinks to indicate that the Ring state is in protected mode.
DI/DO	Red	Blinks to indicate that Switch DC or port has failed or DI has event.

■ Per 10/100/1000BASE-T Port with PoE

LED	Color	Function	
10/100/1000 LNK/ACT	Green	Lights	Indicating the port is running at <b>1000Mbps</b> speed and successfully established.
		Blinks	Indicating that the switch is actively sending or receiving data over that port.
PoE In-Use	Amber	Lights	Indicating the port is providing 48~56V DC in-line power.
		Off	Indicating the connected device is not a PoE Powered Device (PD).

■ Per SFP Interface

LED	Color	Function	
1000 LNK/ACT	Green	Lights	to indicate the port is running at <b>1000Mbps</b> and successfully established.
		Blinks	to indicate that the switch is actively sending or receiving data over that port.
100 LNK/ACT	Amber	Lights	to indicate the port is running at <b>100Mbps</b> and successfully established.
		Blinks	to indicate that the switch is actively sending or receiving data over that port.

**IGS-6325-8UP2S** and **IGS-6325-8UP2S2X**

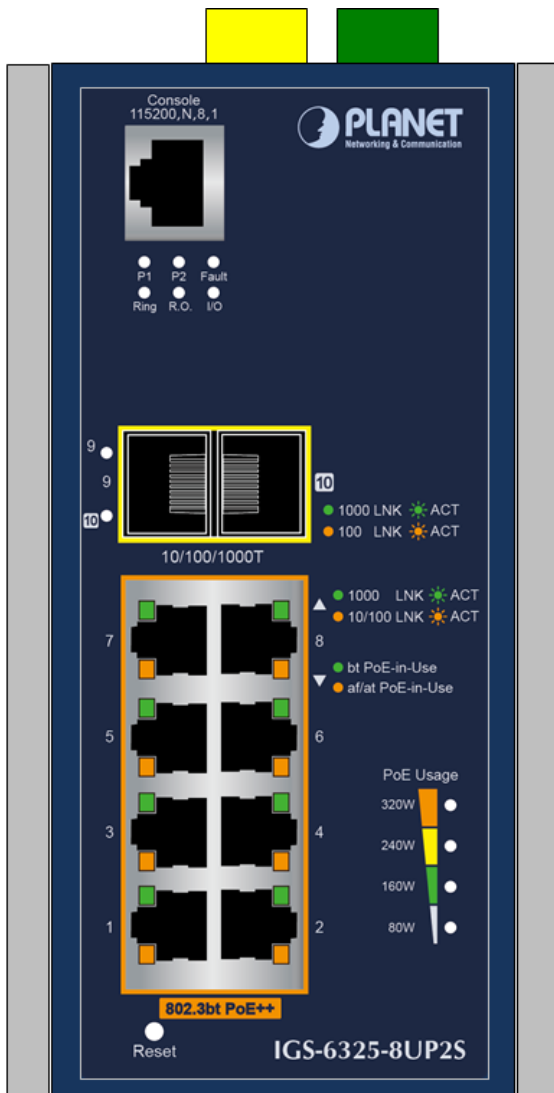

Figure 2-1-6: IGS-6325-16P4S LEDs on Front Panel

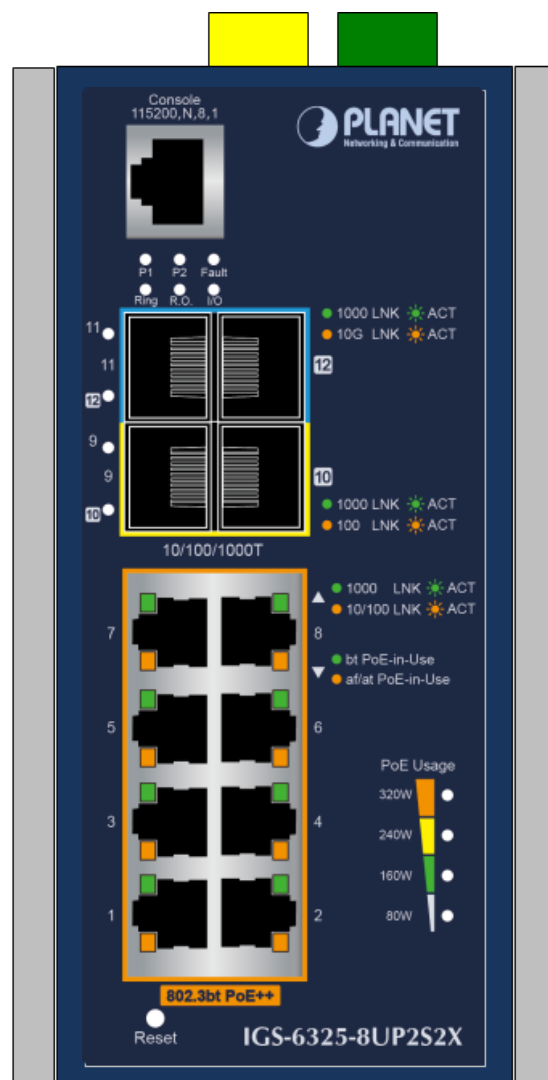

Figure 2-1-7: IGS-6325-16P4S LEDs on Front Panel



■ System

LED	Color	Function
DC1	Green	Lights to indicate DC power input 1 has power.
DC2	Green	Lights to indicate DC power input 2 has power.
Fault	Red	Lights to indicate that Switch DC or port has failed.
Ring	Green	Lights to indicate that the ERPS Ring has been created successfully.
R.O.	Green	Lights to indicate that Ring state is in idle mode.
		Blinks to indicate that the Ring state is in protected mode.
DI/DO	Red	Blinks to indicate that Switch DC or port has failed or DI has event.

■

LED	Color	Function
10/100	Amber	<b>Lights</b> to indicate that the port is operating at 10/100Mbps. <b>Blinks</b> to indicate that the switch is actively sending or receiving data over that port.
1000	Green	<b>Lights</b> to indicate that the port is operating at 1000Mbps. <b>Off</b> to indicate that the switch is actively sending or receiving data over that port.
802.3at PoE	Amber	<b>Lights:</b> To indicate the port is providing DC in-line power with <b>802.3af/at PoE+</b> mode. <b>Off</b> to indicate the connected device is not a PoE Powered Device (PD)
802.3bt PoE	Green	<b>Lights:</b> To indicate the port is providing DC in-line power with <b>802.3bt PoE++</b> mode. <b>Off</b> to indicate the connected device is not a PoE Powered Device (PD)

■ Per SFP Interface

LED	Color	Function
1000 LNK/ACT	Green	<b>Lights</b> to indicate the port is running at <b>1000Mbps</b> and successfully established. <b>Blinks</b> to indicate that the switch is actively sending or receiving data over that port.
100 LNK/ACT	Amber	<b>Lights</b> to indicate the port is running at <b>100Mbps</b> and successfully established. <b>Blinks</b> to indicate that the switch is actively sending or receiving data over that port.

■ Per 1/10G SFP+ Interface (IGS-6325-8UP2S2X)

LED	Color	Function
1000 LNK/ACT	Green	<b>Lights</b> to indicate the port is running at <b>1Gbps</b> and successfully established. <b>Blinks</b> to indicate that the switch is actively sending or receiving data over that port.
10G LNK / ACT	Amber	<b>Lights</b> to indicate the port is running at <b>10Gbps</b> and successfully established. <b>Blinks</b> to indicate that the switch is actively sending or receiving data over that port.

**IGS-6325-8T8S and IGS-6325-8T8S4X**

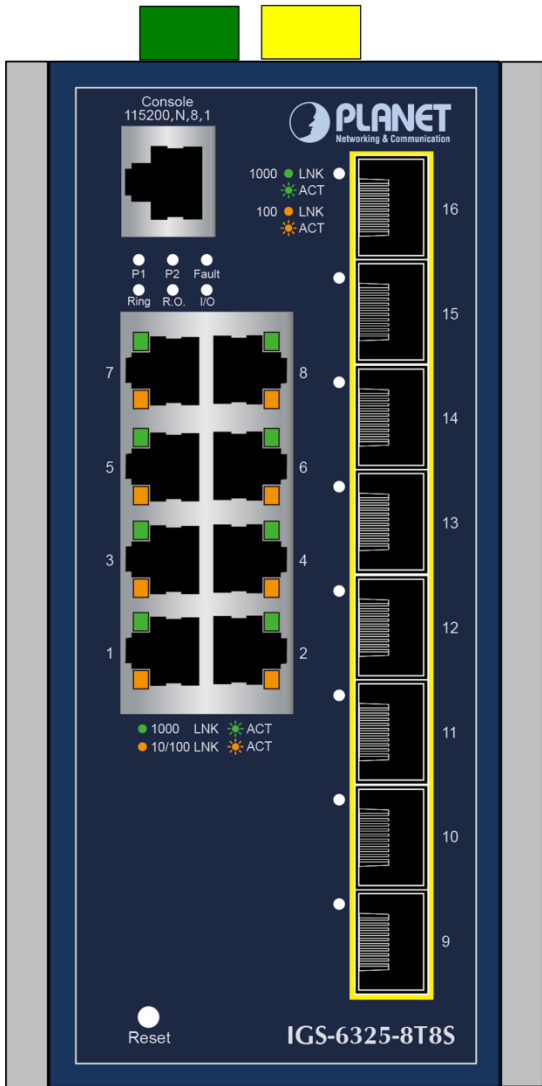

Figure 2-1-8: IGS-6325-8T8S LEDs on Front Panel

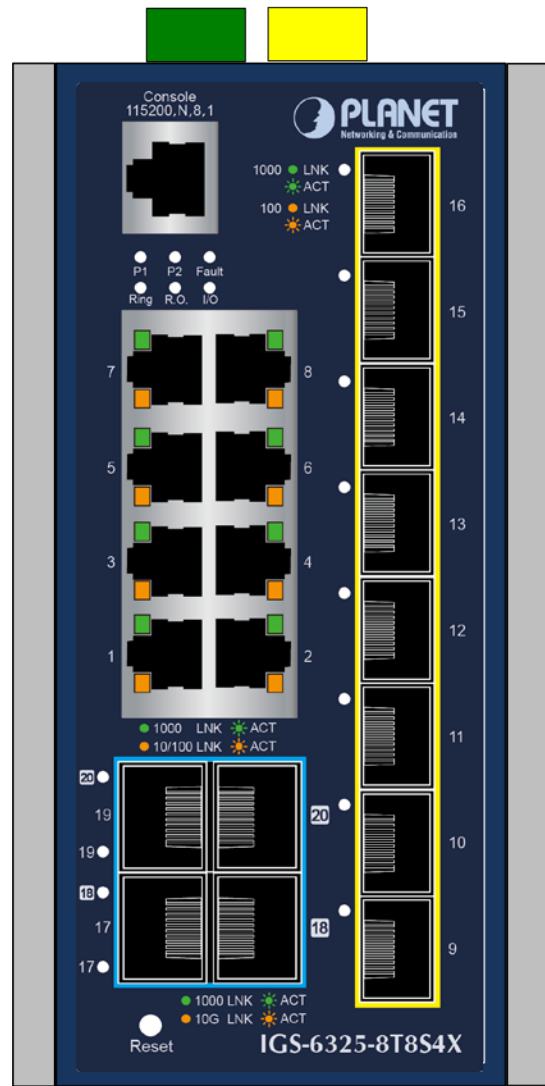

Figure 2-1-9: IGS-6325-8T8S4X LEDs on Front Panel

■ System

LED	Color	Function
DC1	Green	Lights to indicate DC power input 1 has power.
DC2	Green	Lights to indicate DC power input 2 has power.
Fault	Red	Lights to indicate that Switch DC or port has failed.
Ring	Green	Lights to indicate that the ERPS Ring has been created successfully.
R.O.	Green	Lights to indicate that Ring state is in idle mode.
		Blinks to indicate that the Ring state is in protected mode.
DI/DO	Red	Blinks to indicate that Switch DC or port has failed or DI has event.

■ Per 10/100/1000BASE-T RJ45 Port

LED	Color	Function
LNK/ACT	Green	<b>Lights</b> to indicate the port is running at <b>1000Mbps</b> and successfully established. <b>Blinks</b> to indicate that the switch is actively sending or receiving data over that port.
10/100 LNK/ACT	Amber	<b>Light</b> to indicate the port is running at <b>10/100Mbps</b> and successfully established. <b>Blinks</b> to indicate that the switch is actively sending or receiving data over that port.

■ Per SFP Interface

LED	Color	Function
1000 LNK/ACT	Green	<b>Lights</b> to indicate the port is running at <b>1000Mbps</b> and successfully established. <b>Blinks</b> to indicate that the switch is actively sending or receiving data over that port.
100 LNK/ACT	Amber	<b>Lights</b> to indicate the port is running at <b>100Mbps</b> and successfully established. <b>Blinks</b> to indicate that the switch is actively sending or receiving data over that port.

■ Per 1/10G SFP+ Interface (IGS-6325-8T8S4X)

LED	Color	Function
1000 LNK/ACT	Green	<b>Lights</b> to indicate the port is running at <b>1Gbps</b> and successfully established. <b>Blinks</b> to indicate that the switch is actively sending or receiving data over that port.
10G LNK / ACT	Amber	<b>Lights</b> to indicate the port is running at <b>10Gbps</b> and successfully established. <b>Blinks</b> to indicate that the switch is actively sending or receiving data over that port.

## 2.1.4 Switch Upper Panel

The Upper Panel of the **Industrial Managed Switch** comes with a DC inlet power socket and one terminal block connector with 6 contacts.

### ■ DC Power Connector for **IGS-6325-16P4S**, **IGS-6325-8UP2S** and **IGS-6325-8UP2S2X**

The top panels of the IGS-6325-16P4S, IGS-6325-8UP2S and IGS-6325-8UP2S2X contain a DC power connector, which accepts DC power input voltage from **48V to 56V DC**. Connect the power cable to the Industrial Managed Switch at the input terminal block.

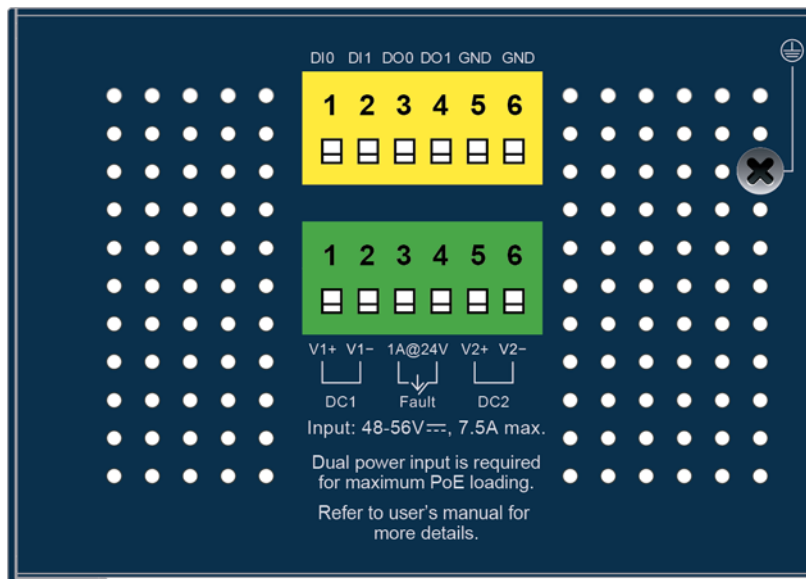

Figure 2-1-10: IGS-6325-16P4S Upper Panel

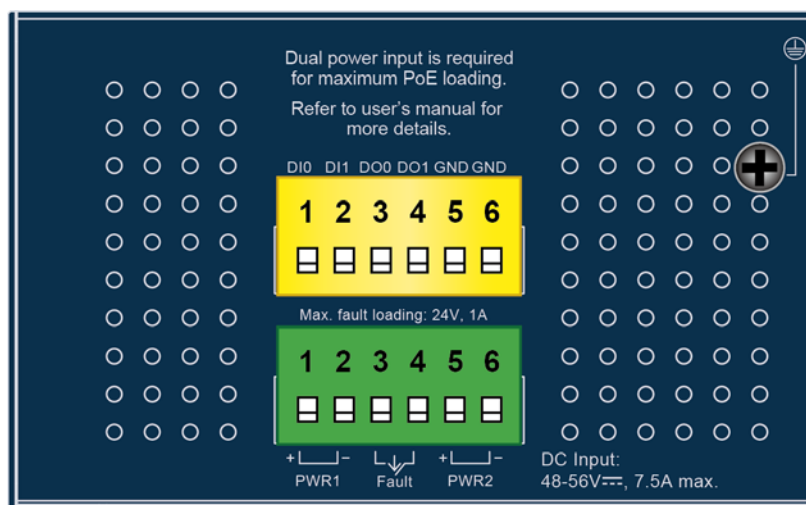

Figure 2-1-11: IGS-6325-8UP2S2X and IGS-6325-8UP2S Upper Panel

■ **DC Power Connector for IGS-6325-8T8S4X and IGS-6325-8T8S**

The top panels of the IGS-6325-8T8S4X and IGS-6325-8T8S contain a DC power connector, which accepts DC power input voltage from **12V to 48V DC**. Connect the power cable to the Industrial Managed Switch at the input terminal block.

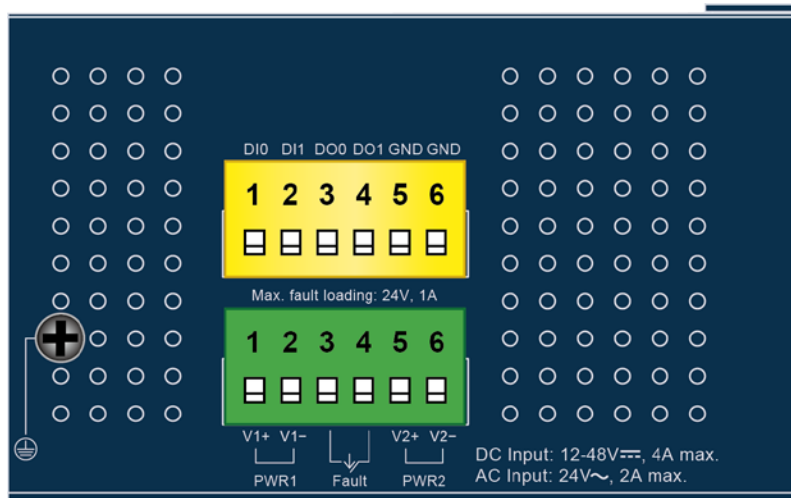

Figure 2-1-12: IGS-6325-8T8S4X, IGS-6325-8T4X and IGS-6325-8T8S Upper Panel

■ **Digital Input**

The digital input of the Industrial Managed Switch can be activated by the external sensor that senses physical changes. These changes can include intrusion detection or certain physical change in the monitored area. For example, the external sensor can be a door switch or an infrared motion detector.

■ **Digital Output**

The digital output main function is to allow the Industrial Managed Switch to trigger external devices, either automatically or by remote control from a human operator or a software application.

## 2.1.5 Wiring the DC Power Input

The 6-contact terminal block connector on the front panel of Industrial Managed Switch is used for two DC redundant power inputs. Please follow the steps below to insert the power wire.

1. Insert positive/negative DC power wires into contacts 1 and 2 for DC Power 1, or 5 and 6 for DC Power 2.

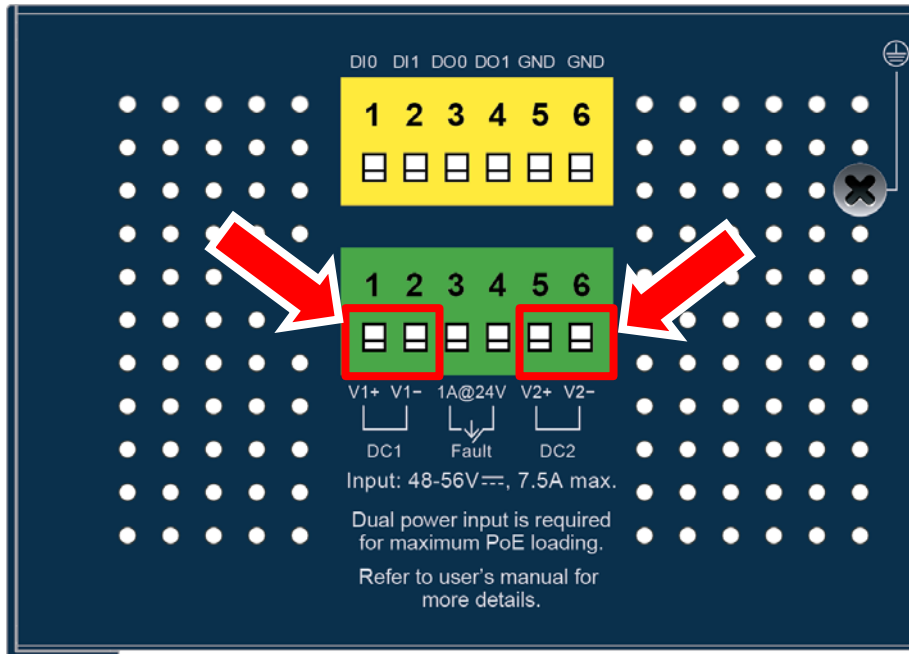

Figure 2-1-11: IGS-6325-16P4S Upper Panel

2. Tighten the wire-clamp screws for preventing the wires from loosening.

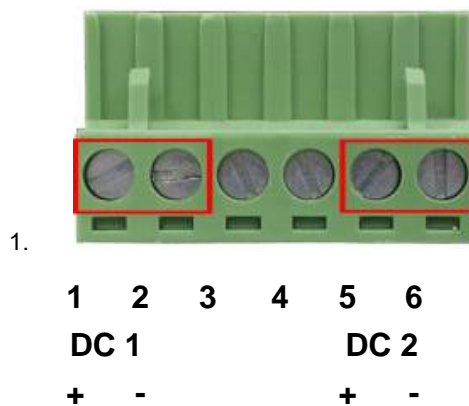

Figure 2-1-12 6-pin Terminal Block Power Wiring Input for IGS-6325-20T4C4X and IGS-325-20S4C4X



1. The wire gauge for the terminal block should be in the range of 12 ~ 24 AWG.
2. When performing any of the procedures like inserting the wires or tightening the wire-clamp screws, make sure the power is OFF to prevent from getting an electric shock.

## 2.1.6 Wiring the Fault Alarm Contact

The fault alarm contacts are in the middle (3 & 4) of the terminal block connector as the picture shows below. Inserting the wires, the **Industrial Managed Switch** will detect the fault status of the power failure, or port link failure (available for managed model).

The following illustration shows an application example for wiring the fault alarm contacts

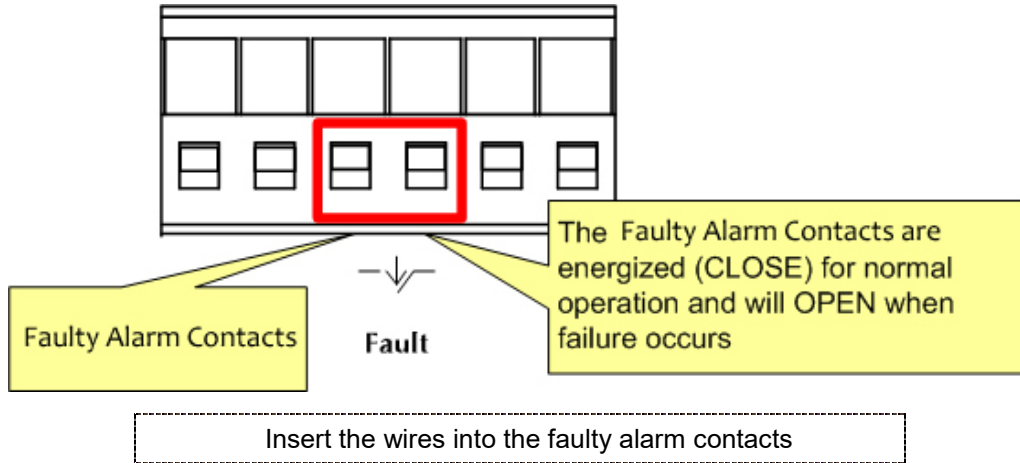

1. The wire gauge for the terminal block should be in the range of 12 ~ 24 AWG.
2. When performing any of the procedures like inserting the wires or tighten the wire-clamp screws, make sure the power is OFF to prevent from getting an electric shock.

## 2.1.7 Wiring the Digital Input/Output

The 6-contact terminal block connector on the front panel of Industrial Managed Switch is used for Digital Input and Digital Output. Please follow the steps below to insert wire.

1. The Industrial Managed Switch offers two DI and DO groups. 1 and 2 are DI groups, 3 and 4 are DO groups, and 5 and 6 are GND (ground).

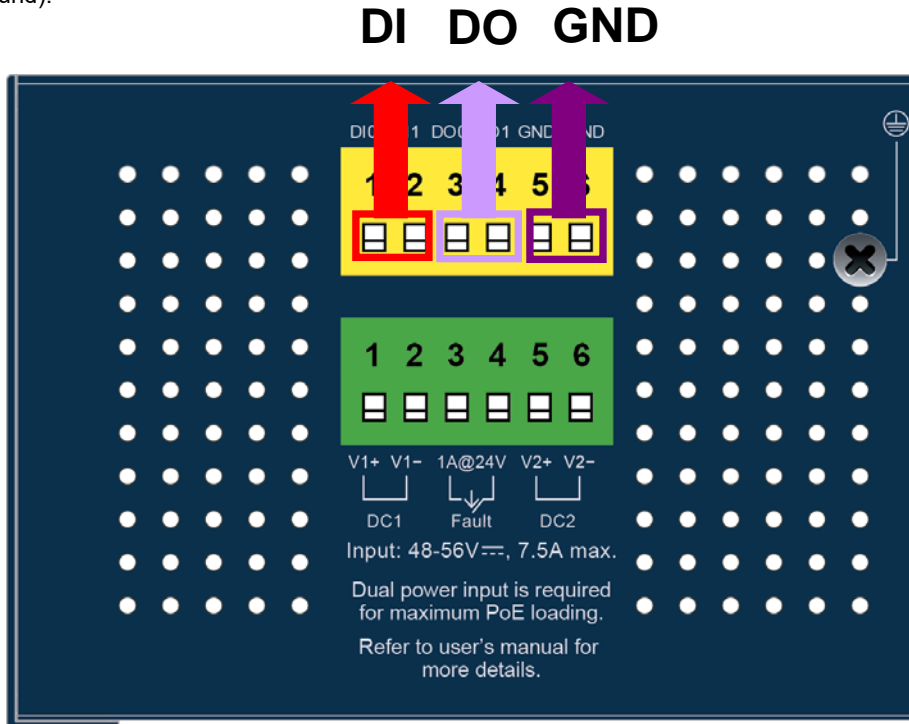

Figure 2-1-13 Wiring the DI and DO of IGS-6325-20T4C4X and IGS-6325-20S4C4X

2. Tighten the wire-clamp screws for preventing the wires from loosening.

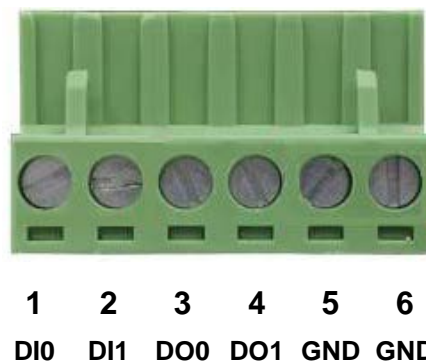

Figure 2-1-14 6-pin Terminal Block for DI and DO Wiring Input

3. There are two **Digital Input** groups for you to monitor two different devices. The following topology shows how to wire DI0 and DI1.



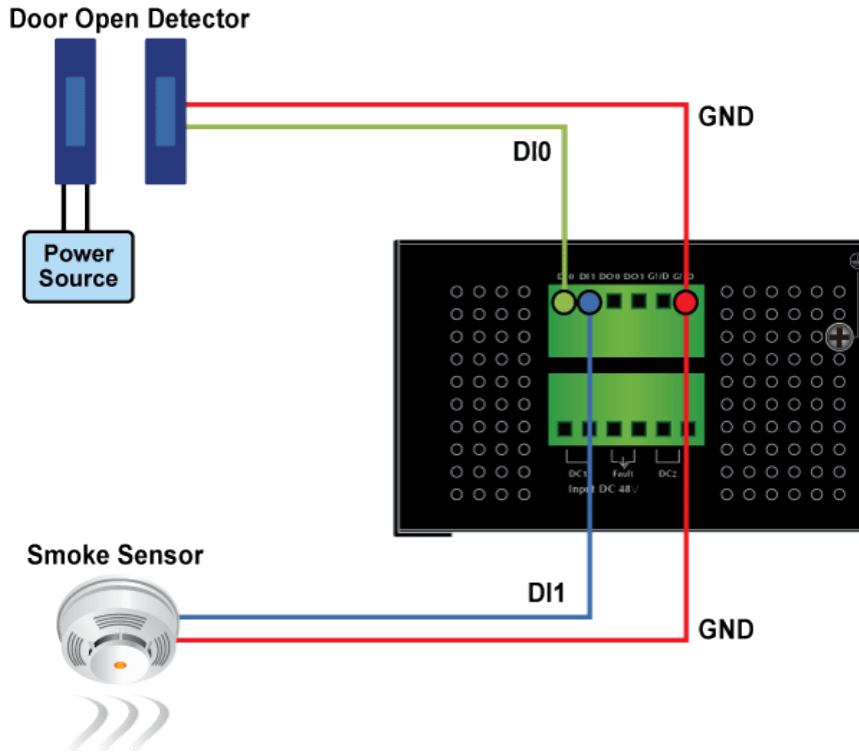

Figure 2-1-15 Wires D10 and D11 to Open Detector

- There are two **Digital Output** groups for you to sense Industrial Managed Switch port failure or power failure and issue a high or low signal to external device. The following topology shows how to wire DO0 and DO1.

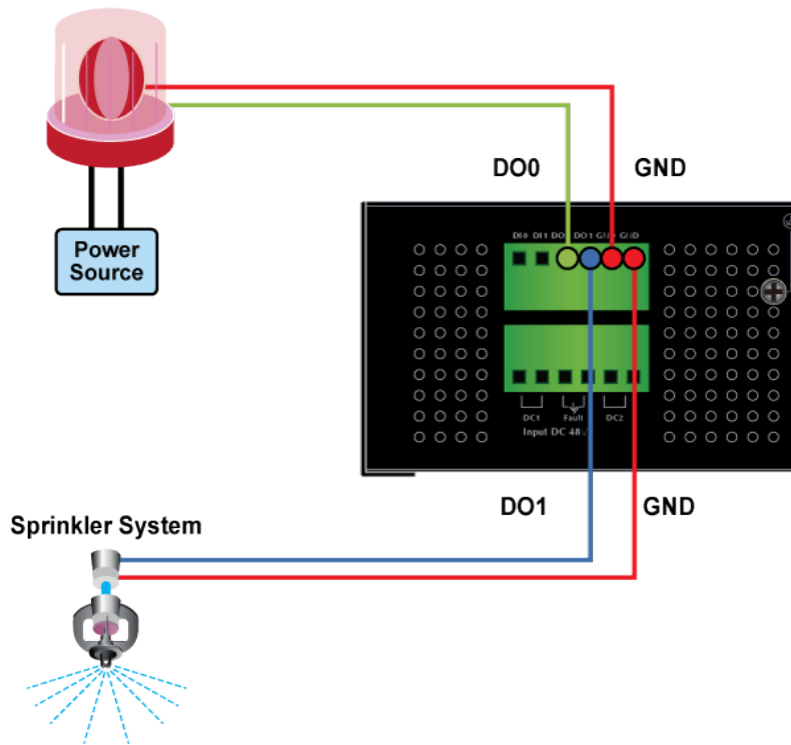

Figure 2-1-16 Wires DO0 and DO1 to Open Detector

## 2.2 Installing the Industrial Managed Switch

This section describes how to install your **Industrial Managed Switch** and make connections to the **Industrial Managed Switch**. Please read the following topics and perform the procedures in the order being presented. To install your **Industrial Managed Switch** on a desktop or shelf, simply complete the following steps.

In this paragraph, we will describe how to install the **Industrial Managed Switch** and the installation points attended to it.

### 2.2.1 Installation Steps

1. **Unpack the Industrial Managed Switch**
2. **Check if the DIN-rail bracket is screwed on the Industrial Managed Switch or not.** If the DIN-rail bracket is not screwed on the **Industrial Managed Switch**, refer to **DIN-rail Mounting** section for DIN-rail installation. If users want to wall-mount the **Industrial Managed Switch**, refer to the **Wall Mount Plate Mounting** section for wall-mount plate installation.
3. **To hang the Industrial Managed Switch on the DIN-rail track or wall.**
4. **Power on the Industrial Managed Switch.** Please refer to the **Wiring the Power Inputs** section for knowing the information about how to wire the power. The power LED on the **Industrial Managed Switch** will light up. Please refer to the **LED Indicators** section for indication of LED lights.
5. **Prepare the twisted-pair, straight-through Category 5 cable for Ethernet connection.**
6. **Insert one side of RJ45 cable (category 5) into the Industrial Managed Switch Ethernet port** (RJ45 port) while the other side to the network device's Ethernet port (RJ45 port), e.g., switch PC or server. The UTP port (RJ45) LED on the **Industrial Managed Switch** will light up when the cable is connected with the network device. Please refer to the **LED Indicators** section for LED light indication.

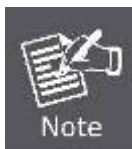

Make sure that the connected network devices support MDI/MDI-X. If it does not support, use the crossover Category 5 cable.

7. **When all connections are set and all LED lights show normal, the installation is completed.**

## 2.2.2 DIN-rail Mounting

This section describes how to install the **Industrial Managed Switch**. There are two methods to install the **Industrial Managed Switch** -- DIN-rail mounting and wall-mount plate mounting. Please read the following topics and perform the procedures in the order being presented.



Follow all the DIN-rail installation steps as shown in the example.

**Step 1:** Screw the DIN-rail bracket on the **Industrial Managed Switch**.



**Step 2:** Lightly slide the DIN-rail bracket into the track.



**Step 3:** Check whether the DIN-rail bracket is tightly on the track.

Please refer to the following procedures to remove the **Industrial Managed Switch** from the track.

**Step 4:** Lightly remove the unit from the track.



## 2.2.3 Wall-mount Plate Mounting

To install the **Industrial Managed Switch** on the wall, please follow the instructions below.



Follow all the DIN-rail installation steps as shown in the example.

**Step 1:** Remove the DIN-rail bracket from the **Industrial Managed Switch**. Use the screwdriver to loosen the screws to remove the bracket.

**Step 2:** Place the wall-mount plate on the rear panel of the **Industrial Managed Switch**.



**Step 3:** Use the screwdriver to screw the wall-mount plate on the **Industrial Managed Switch**.

**Step 4:** Use the hook holes at the corners of the wall mount plate to hang the **Industrial Managed Switch** on the wall.

**Step 5:** To remove the wall-mount plate, reverse the steps above.

## 2.3 Cabling

### ■ 10/100/1000BASE-T and 100BASE-FX/1000BASE-SX/LX

All 10/100/1000BASE-T ports come with auto-negotiation capability. They automatically support 1000BASE-T, 100BASE-TX and 10BASE-T networks. Users only need to plug a working network device into one of the 10/100/1000BASE-T ports, and then turn on the **Industrial Managed Switch**. The port will automatically run at 10Mbps, 20Mbps, 100Mbps or 200Mbps and 1000Mbps or 2000Mbps after negotiating with the connected device. The **Industrial Managed Switch** has SFP interfaces that support 100/1000Mbps dual speed mode (Optional multi-mode/single-mode 100BASE-FX/1000BASE-SX/LX SFP module)

### ■ Cabling

Each 10/100/1000BASE-T port uses RJ45 sockets -- similar to phone jacks -- for connection of unshielded twisted-pair cable (UTP). The IEEE 802.3/802.3u 802.3ab Fast/Gigabit Ethernet standard requires Category 5 UTP for 100Mbps 100BASE-TX. 10BASE-T networks can use Cat.3, 4, 5 or 1000BASE-T uses 5/5e/6 UTP (see table below). Maximum distance is 100 meters (328 feet). The 100BASE-FX/1000BASE-SX/LX SFP slot is used as LC connector with optional SFP module. Please see table below and know more about the cable specifications.

Port Type	Cable Type	Connector
10BASE-T	Cat 3, 4, 5, 2-pair	RJ45
100BASE-TX	Cat.5 UTP, 2-pair	RJ45
1000BASE-T	Cat.5/5e/6 UTP, 2-pair	RJ45
100BASE-FX	50/125µm or 62.5 / 125µm multi-mode 9/125µm single-mode	LC (multi/single mode)
1000BASE-SX/LX	50/125µm or 62.5 / 125µm multi-mode 9/125µm single-mode	LC (multi/single mode)
10GBASE-SR/LR	50/125µm or 62.5 / 125µm multi-mode 9/125µm single-mode	LC (multi/single mode)

Any Ethernet devices like hubs/PCs can be connected to the **Industrial Managed Switch** by using straight-through wires. The two 10/100/1000Mbps ports are auto-MDI/MDI-X, which can be used on straight-through or crossover cable.

### 2.3.1 Installing the SFP Transceiver

The sections describe how to insert an SFP/SFP+ transceiver into an SFP/SFP+ slot. The SFP/SFP+ transceivers are hot-pluggable and hot-swappable. You can plug in and out the transceiver to/from any SFP/SFP+ port without having to power down the **Industrial Managed Switch** as [Figure 2-3-1](#) appears.



**Follow all the SFP installation steps as shown in the example.**

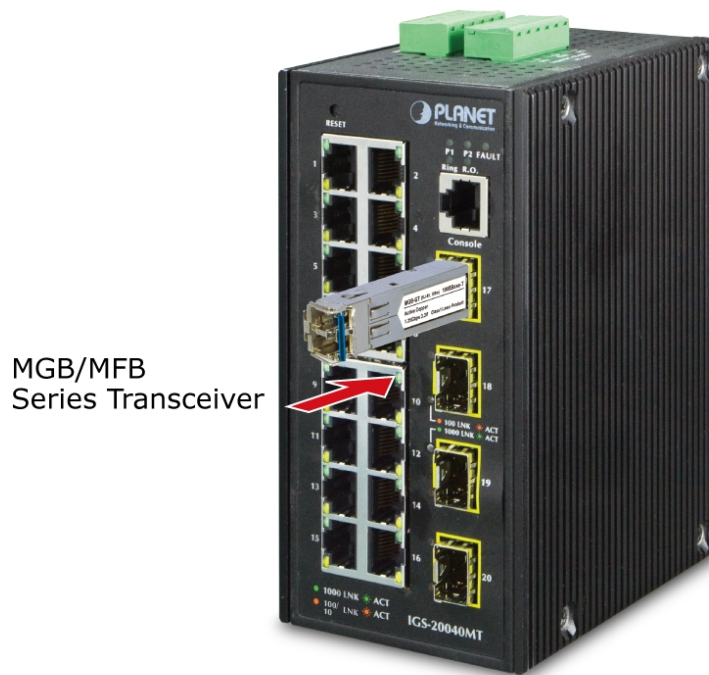

**Figure 2-3-1:** Plug in the SFP/SFP+ Transceiver

■ **Approved PLANET SFP/SFP+ Transceivers**

PLANET **Industrial Managed Switch** supports both single mode and multi-mode SFP transceivers. The following list of approved PLANET SFP/SFP+ transceivers is correct at the time of publication:

**Fast Ethernet Transceiver (100BASE-X SFP)**

Model	Speed (Mbps)	Connector Interface	Fiber Mode	Distance	Wavelength (nm)	Operating Temp.
MFB-FX	100	LC	Multi Mode	2km	1310nm	0 ~ 60 degrees C
MFB-F20	100	LC	Single Mode	20km	1310nm	0 ~ 60 degrees C
MFB-F40	100	LC	Single Mode	40km	1310nm	0 ~ 60 degrees C
MFB-F60	100	LC	Single Mode	60km	1310nm	0 ~ 60 degrees C
MFB-TFX	100	LC	Multi Mode	2km	1310nm	-40 ~ 75 degrees C
MFB-TF20	100	LC	Single Mode	20km	1310nm	-40 ~ 75 degrees C

**Fast Ethernet Transceiver (100BASE-BX, Single Fiber Bi-directional SFP)**

Model	Speed (Mbps)	Connector Interface	Fiber Mode	Distance	Wavelength (TX/RX)	Operating Temp.
MFB-FA20	100	WDM(LC)	Single Mode	20km	1310nm/1550nm	0 ~ 60 degrees C
MFB-FB20	100	WDM(LC)	Single Mode	20km	1550nm/1310nm	0 ~ 60 degrees C
MFB-TFA20	100	WDM(LC)	Single Mode	20km	1310nm/1550nm	-40 ~ 75 degrees C
MFB-TFB20	100	WDM(LC)	Single Mode	20km	1550nm/1310nm	-40 ~ 75 degrees C
MFB-TFA40	100	WDM(LC)	Single Mode	40km	1310nm/1550nm	-40 ~ 75 degrees C
MFB-TFB40	100	WDM(LC)	Single Mode	40km	1550nm/1310nm	-40 ~ 75 degrees C

**Gigabit Ethernet Transceiver (1000BASE-X SFP)**

Model	Speed (Mbps)	Connector Interface	Fiber Mode	Distance	Wavelength (nm)	Operating Temp.
MGB-GT	1000	Copper	--	100m	--	0 ~ 60 degrees C
MGB-SX	1000	LC	Multi Mode	550m	850nm	0 ~ 60 degrees C
MGB-SX2	1000	LC	Multi Mode	2km	1310nm	0 ~ 60 degrees C
MGB-LX	1000	LC	Single Mode	20km	1310nm	0 ~ 60 degrees C
MGB-L40	1000	LC	Single Mode	40km	1310nm	0 ~ 60 degrees C
MGB-L80	1000	LC	Single Mode	80km	1550nm	0 ~ 60 degrees C
MGB-L120	1000	LC	Single Mode	120km	1550nm	0 ~ 60 degrees C
MGB-TSX	1000	LC	Multi Mode	550m	850nm	-40 ~ 75 degrees C
MGB-TLX	1000	LC	Single Mode	20km	1310nm	-40 ~ 75 degrees C
MGB-TL40	1000	LC	Single Mode	40km	1310nm	-40 ~ 75 degrees C
MGB-TL40	1000	LC	Single Mode	80km	1550nm	-40 ~ 75 degrees C

**Gigabit Ethernet Transceiver (1000BASE-BX, Single Fiber Bi-directional SFP)**

Model	Speed (Mbps)	Connector Interface	Fiber Mode	Distance	Wavelength (TX/RX)	Operating Temp.
MGB-LA10	1000	WDM(LC)	Single Mode	10km	1310nm/1550nm	0 ~ 60 degrees C
MGB-LB10	1000	WDM(LC)	Single Mode	10km	1550nm/1310nm	0 ~ 60 degrees C
MGB-LA20	1000	WDM(LC)	Single Mode	20km	1310nm/1550nm	0 ~ 60 degrees C
MGB-LB20	1000	WDM(LC)	Single Mode	20km	1550nm/1310nm	0 ~ 60 degrees C
MGB-LA40	1000	WDM(LC)	Single Mode	40km	1310nm/1550nm	0 ~ 60 degrees C
MGB-LB40	1000	WDM(LC)	Single Mode	40km	1550nm/1310nm	0 ~ 60 degrees C
MGB-LA60	1000	WDM(LC)	Single Mode	60km	1310nm/1550nm	0 ~ 60 degrees C
MGB-LB60	1000	WDM(LC)	Single Mode	60km	1550nm/1310nm	0 ~ 60 degrees C
MGB-TLA10	1000	WDM(LC)	Single Mode	10km	1310nm/1550nm	-40 ~ 75 degrees C
MGB-TLB10	1000	WDM(LC)	Single Mode	10km	1550nm/1310nm	-40 ~ 75 degrees C
MGB-TLA20	1000	WDM(LC)	Single Mode	20km	1310nm/1550nm	-40 ~ 75 degrees C
MGB-TLB20	1000	WDM(LC)	Single Mode	20km	1550nm/1310nm	-40 ~ 75 degrees C
MGB-TLA40	1000	WDM(LC)	Single Mode	40km	1310nm/1550nm	-40 ~ 75 degrees C
MGB-TLB40	1000	WDM(LC)	Single Mode	40km	1550nm/1310nm	-40 ~ 75 degrees C
MGB-TLA60	1000	WDM(LC)	Single Mode	60km	1310nm/1550nm	-40 ~ 75 degrees C
MGB-TLB60	1000	WDM(LC)	Single Mode	60km	1550nm/1310nm	-40 ~ 75 degrees C



**10Gbps SFP+ (10G Ethernet/10GBASE)**

Model	Speed (Mbps)	Connector Interface	Fiber Mode	Distance	Wavelength (nm)	Operating Temp.
MTB-SR	10G	LC	Multi Mode	Up to 300m	850nm	0 ~ 60 degrees C
MTB-LR	10G	LC	Single Mode	10km	1310nm	0 ~ 60 degrees C

**10Gbps SFP+ (10GBASE-BX, Single Fiber Bi-directional SFP)**

Model	Speed (Mbps)	Connector Interface	Fiber Mode	Distance	Wavelength (TX)	Wavelength (RX)	Operating Temp.
MTB-LA20	10G	WDM(LC)	Single Mode	20km	1270nm	1330nm	0 ~ 60 degrees C
MTB-LB20	10G	WDM(LC)	Single Mode	20km	1330nm	1270nm	0 ~ 60 degrees C
MTB-LA40	10G	WDM(LC)	Single Mode	40km	1270nm	1330nm	0 ~ 60 degrees C
MTB-LB40	10G	WDM(LC)	Single Mode	40km	1330nm	1270nm	0 ~ 60 degrees C
MTB-LA60	10G	WDM(LC)	Single Mode	60km	1270nm	1330nm	0 ~ 60 degrees C
MTB-LB60	10G	WDM(LC)	Single Mode	60km	1330nm	1270nm	0 ~ 60 degrees C



1. It is recommended to use PLANET SFP on the **Industrial Managed Switch**. If you insert an SFP/SFP+ transceiver that is not supported, the **Industrial Managed Switch** will not recognize it.
2. Please choose the SFP/SFP+ transceiver which can be operated at the temperature range of -40~75 degrees C if the switch device is working in a 0~50 degrees C temperature environment.

1. Before we connect the Industrial Managed Switch to the other network device, we have to make sure both sides of the SFP transceivers are with the same media type, for example: 1000BASE-SX to 1000BASE-SX, 1000BASE-LX to 1000BASE-LX.
2. Check whether the fiber-optic cable type matches with the SFP transceiver requirement.
  - To connect to 1000BASE-SX SFP transceiver, please use the multi-mode fiber cable with one side being the male duplex LC connector type.
  - To connect to 1000BASE-LX SFP transceiver, please use the single-mode fiber cable with one side being the male duplex LC connector type.

● **Connect the fiber cable**

1. Insert the duplex LC connector into the SFP/SFP+ transceiver.
2. Connect the other end of the cable to a device with SFP/SFP+ transceiver installed.
3. Check the LNK/ACT LED of the SFP/SFP+ slot on the front of the Managed Switch. Ensure that the SFP/SFP+ transceiver is operating correctly.
4. Check the Link mode of the SFP/SFP+ port if the link fails. To function with some fiber-NICs or Media Converters, user has to set the port Link mode to “**10G FDX**”, “**1000M FDX**” or “**100M FDX**”.

### 2.3.2 Removing the SFP/SFP+ Transceiver

1. Make sure there is no network activity by consulting or checking with the network administrator. Or through the management interface of the switch/converter (if available) to disable the port in advance.
2. Remove the fiber optic cable gently.
3. Turn the lever of the SFP transceiver to a horizontal position.
4. Pull out the module gently through the lever.

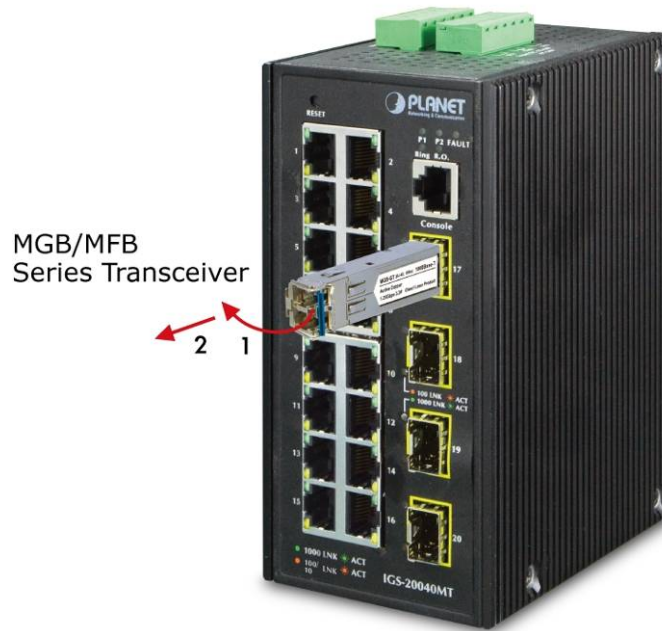

**Figure 2-3-2:** Pull out the SFP/SFP+ Transceiver Module



Never pull out the module without pulling the lever or the push bolts on the module. Directly pulling out the module with force could damage the module and SFP module slot of the device.

## 3. SWITCH MANAGEMENT

This chapter explains the methods that you can use to configure management access to the **Industrial Managed Switch**. It describes the types of management applications and the communication and management protocols that deliver data between your management device (workstation or personal computer) and the system. It also contains information about port connection options.

**This chapter covers the following topics:**

- Requirements
- Management Access Overview
- Remote Telnet Access
- Web Management Access
- SNMP Access
- Standards, Protocols, and Related Reading

### 3.1 Requirements

- Workstation running Windows XP/2003, Vista, Windows 7/8/10, MAC OS X, Linux, Fedora, Ubuntu or other platform is compatible with **TCP/IP** protocols.
- **Workstation** is installed with **Ethernet NIC** (Network Interface Card)
- **Serial Port** (Terminal)
  - The above PC comes with COM Port (DB9/RS232) or USB-to-RS232 converter
- Ethernet Port
  - Network cables -- Use standard network (UTP) cables with RJ45 connectors.
- The above workstation is installed with **Web browser** and **JAVA runtime environment** Plug-in



It is recommended to use Internet Explorer 8.0 or above to access **Industrial Managed Switch**.

---

## 3.2 Management Access Overview

The **Industrial Managed Switch** gives you the flexibility to access and manage it using any or all of the following methods:

- Remote Telnet Interface
- **Web browser** Interface
- An external **SNMP-based network management application**

The remote Telnet and Web browser interfaces are embedded in the **Industrial Managed Switch** software and are available for immediate use. Each of these management methods has their own advantages. Table 3-1 compares the three management methods.

Method	Advantages	Disadvantages
<b>Console</b>	<ul style="list-style-type: none"> <li>• No IP address or subnet needed</li> <li>• Text-based</li> <li>• Telnet functionality and HyperTerminal built into Windows 95/98/NT/2000/ME/XP operating systems</li> <li>• ProComm Plus, putty, Tera term</li> <li>• Secure</li> </ul>	<ul style="list-style-type: none"> <li>• Must be near the switch or use dial-up connection</li> <li>• Not convenient for remote users</li> <li>• Modem connection may prove to be unreliable or slow</li> </ul>
<b>Remote Telnet</b>	<ul style="list-style-type: none"> <li>• Text-based</li> <li>• Telnet functionality built into Windows XP/2003, Vista, Windows 7 operating systems</li> <li>• Can be accessed from any location</li> </ul>	<ul style="list-style-type: none"> <li>• Security can be compromised (hackers need only know the IP address)</li> </ul>
<b>Web Browser</b>	<ul style="list-style-type: none"> <li>• Ideal for configuring the switch remotely</li> <li>• Compatible with all popular browsers</li> <li>• Can be accessed from any location</li> <li>• Most visually appealing</li> </ul>	<ul style="list-style-type: none"> <li>• Security can be compromised (hackers need only know the IP address and subnet mask)</li> <li>• May encounter lag times on poor connections</li> </ul>
<b>SNMP Agent</b>	<ul style="list-style-type: none"> <li>• Communicates with switch functions at the MIB level</li> <li>• Based on open standards</li> </ul>	<ul style="list-style-type: none"> <li>• Requires SNMP manager software</li> <li>• Least visually appealing of all three methods</li> <li>• Some settings require calculations</li> <li>• Security can be compromised (hackers need only know the community name)</li> </ul>

**Table 3-1:** Management Methods Comparison

### 3.3 CLI Mode Management

There are two ways for CLI mode management, one is remote telnet and the other operated from console port. Remote telnet is an IP-based protocol and console port is for user to operate the Industrial Managed Switch locally only; however, their operations are the same.

The command line user interface is for performing system administration, such as displaying statistics or changing option settings. When this method is used, you can access the **Industrial Managed Switch** remote telnet interface from personal computer or workstation in the same Ethernet environment as long as you know the current IP address of the **Industrial Managed Switch**.

#### IGS Industrial Managed Switch



Console Port  
115200,N,8,1

RJ45 to DB9 RS232 Cable

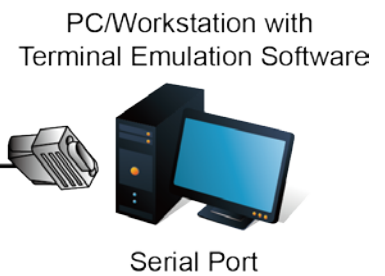

Serial Port

#### Direct Access

Direct access to the administration console is achieved by directly connecting a terminal or a PC equipped with a terminal-emulation program (such as HyperTerminal, ProComm Plus, putty, Tera term) to the Managed Switch console (serial) port. When using this management method, a **straight DB9 RS-232 cable** is required to connect the switch to the PC. After making this connection, configure the terminal-emulation program to use the following parameters:

The default parameters are:

- 115200 bps baud rate
- 8 data bits
- No parity
- 1 stop bit



You can change these settings, if desired, after you log on. This management method is often preferred because you can remain connected and monitor the system during system reboots. Also, certain error messages are sent to the serial port, regardless of the interface through which the associated action was initiated. A Macintosh or PC attachment can use any terminal-emulation program for connecting to the terminal serial port. A workstation attachment under UNIX can use an emulator.

### 3.3.1 Logging on to the Console

Once the terminal has been connected to the device, power on the Industrial Managed Switch and the terminal will display "running testing procedures".

Then, the following message asks to log in user name and password. The factory default user name and password are shown as follows as the login screen in Figure 3-1 appears

User Name: **admin**  
Password: **admin**



Figure 3-1: Console Login Screen

The user can now enter commands to manage the Industrial Managed Switch. For a detailed description of the commands, please refer to the following chapters.



1. For security reason, **please change and memorize the new password after this first setup.**
2. Only accept command in lowercase letter under console interface.

### 3.3.2 Remote Telnet

In Windows system, you may click “**Start**” and then choose “**Accessories**” and “**Command Prompt**”. Please input “**telnet 192.168.0.100**” and press “**enter**” from your keyboard. You will see the following screen appears as Figure 3-2 shows.

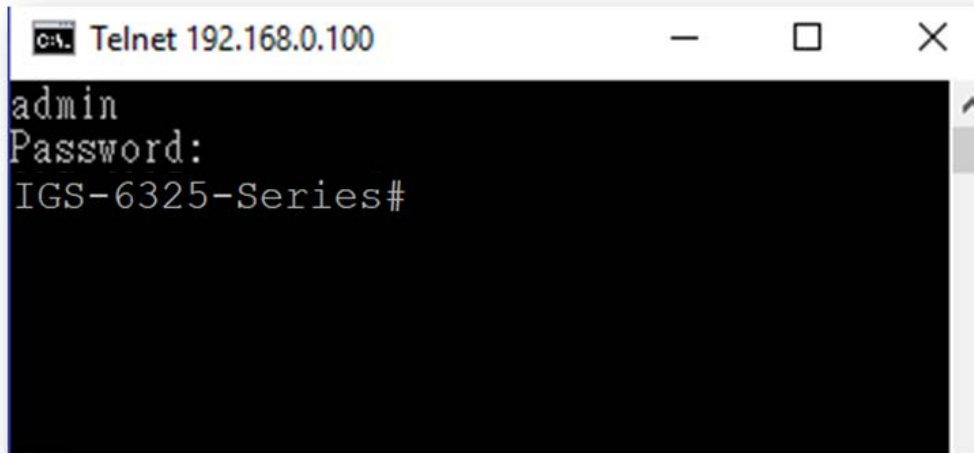

**Figure 3-2:** Remote Telnet Interface Main Screen of Industrial Managed Switch

### 3.4 Web Management

The **Industrial Managed Switch** offers management features that allow users to manage the **Industrial Managed Switch** from anywhere on the network through a standard browser such as Microsoft Internet Explorer. After you set up your IP address for the **Industrial Managed Switch**, you can access the **Industrial Managed Switch's** Web interface applications directly in your Web browser by entering the IP address of the **Industrial Managed Switch**.

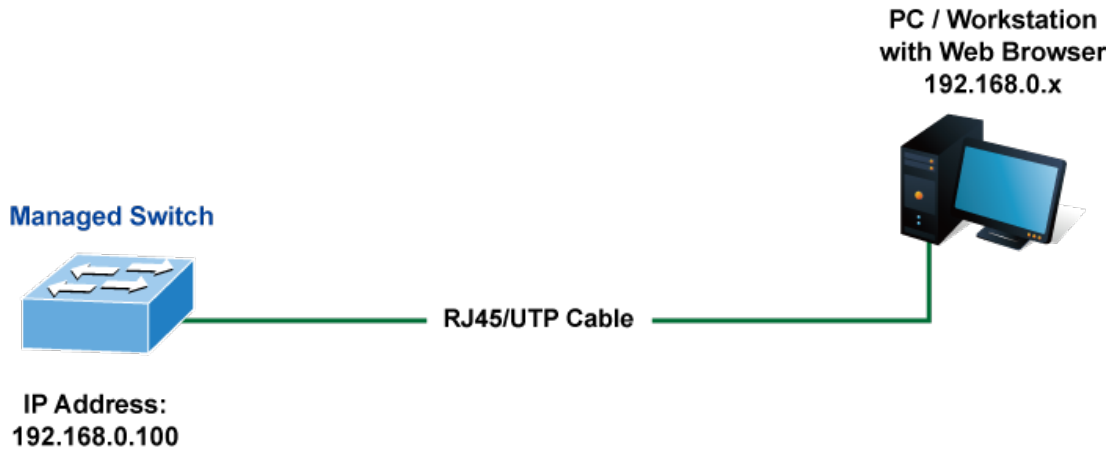

Figure 3-3: Web Management

You can then use your Web browser to list and manage the **Industrial Managed Switch** configuration parameters from one central location; the Web Management requires **Microsoft Internet Explorer 8.0** or later.

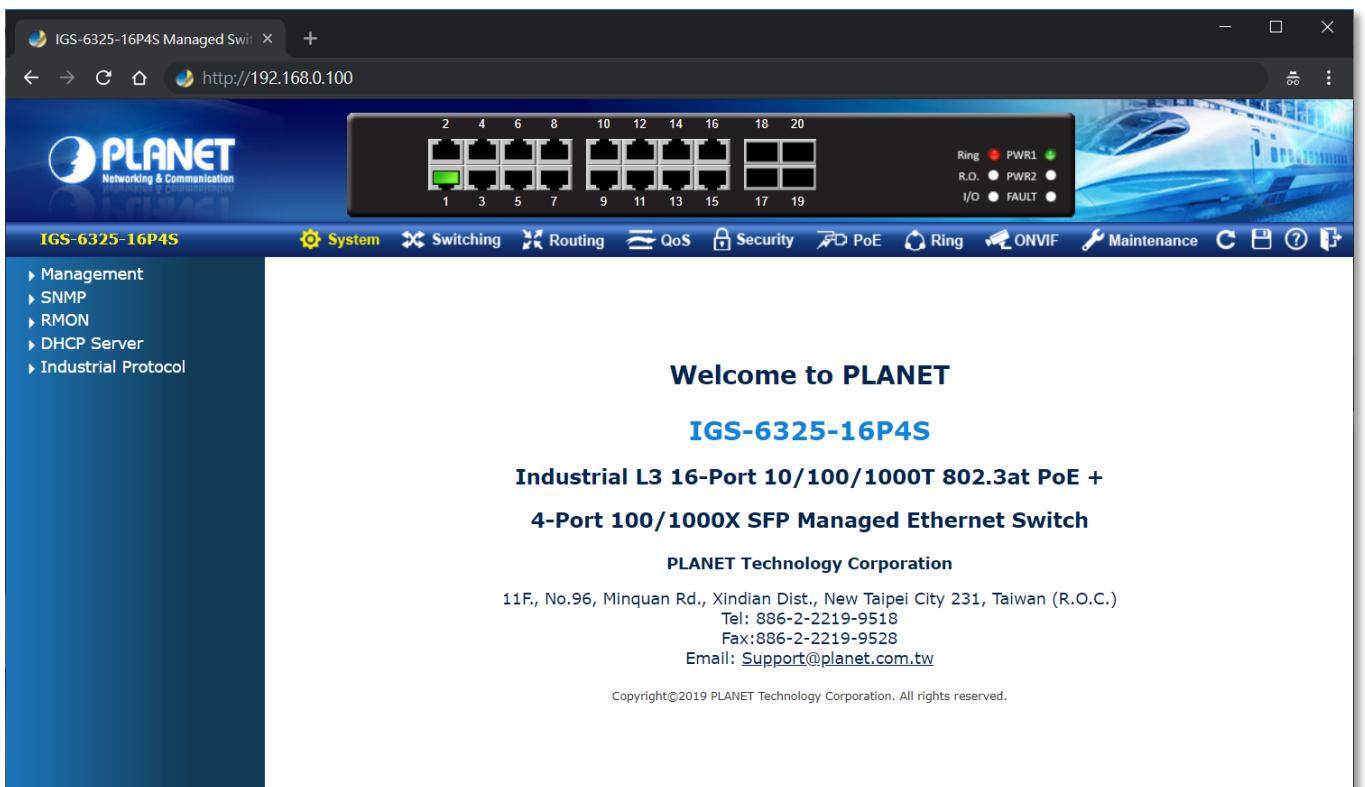

Figure 3-4: Web Main Screen of Industrial Managed Switch



### 3.5 SNMP-based Network Management

You can use an external SNMP-based application to configure and manage the **Industrial Managed Switch**, such as SNMP Network Manager, HP Openview Network Node Management (NNM) or What's Up Gold. This management method requires the SNMP agent on the **Industrial Managed Switch** and the SNMP Network Management Station to use the **same community string**. This management method, in fact, uses two community strings: the **get community string** and the **set community string**.

If the SNMP Network Management Station only knows the set community string, it can read and write to the MIBs. However, if it only knows the get community string, it can only read MIBs. The default gets and sets community strings for the **Industrial Managed Switch** are public.

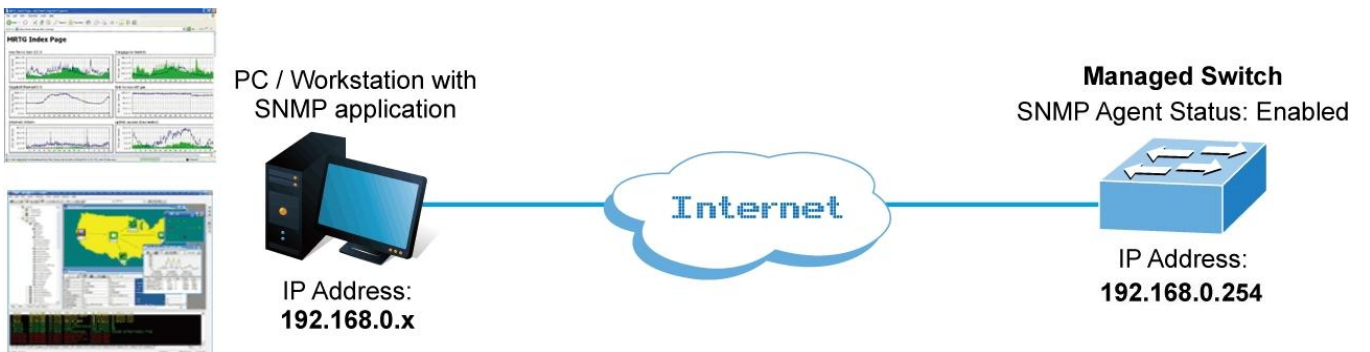

Figure 3-5: SNMP Management

### 3.6 PLANET Smart Discovery Utility

To easily list the **Industrial Managed Switch** in your Ethernet environment, the Planet Smart Discovery Utility from user's manual CD-ROM is an ideal solution. The following install instructions guide you to running the Planet Smart Discovery Utility.

1. Open the Planet Smart Discovery Utility in administrator PC.
2. Run this utility and the following screen appears.

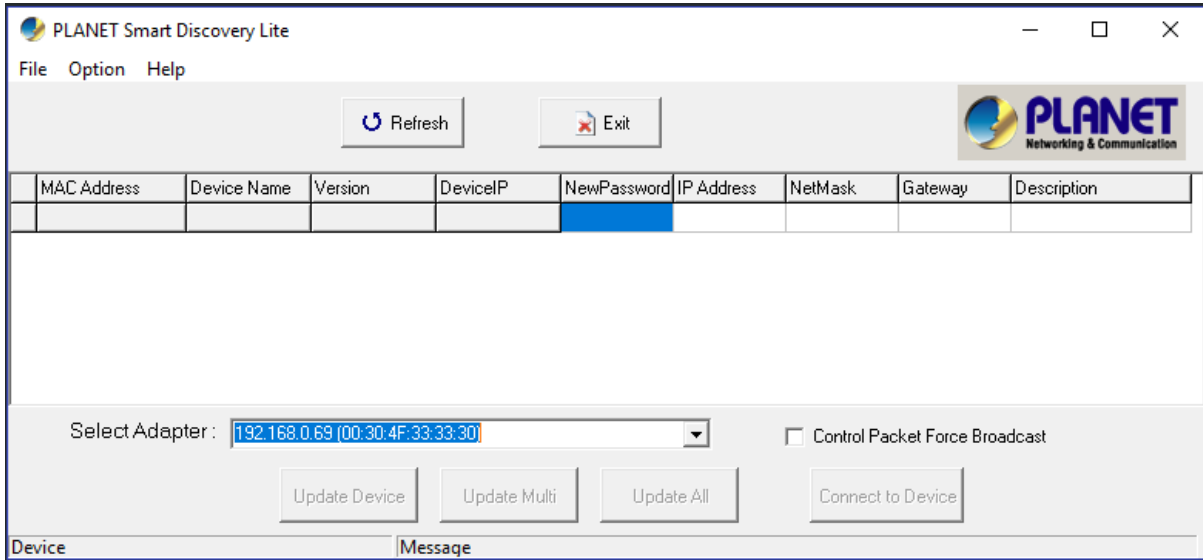

Figure 3-6: Planet Smart Discovery Utility Screen



If there are two LAN cards or above in the same administrator PC, choose a different LAN card by using the **“Select Adapter”** tool.

3. Press the **“Refresh”** button for the currently connected devices in the discovery list as the screen is shown as follows.

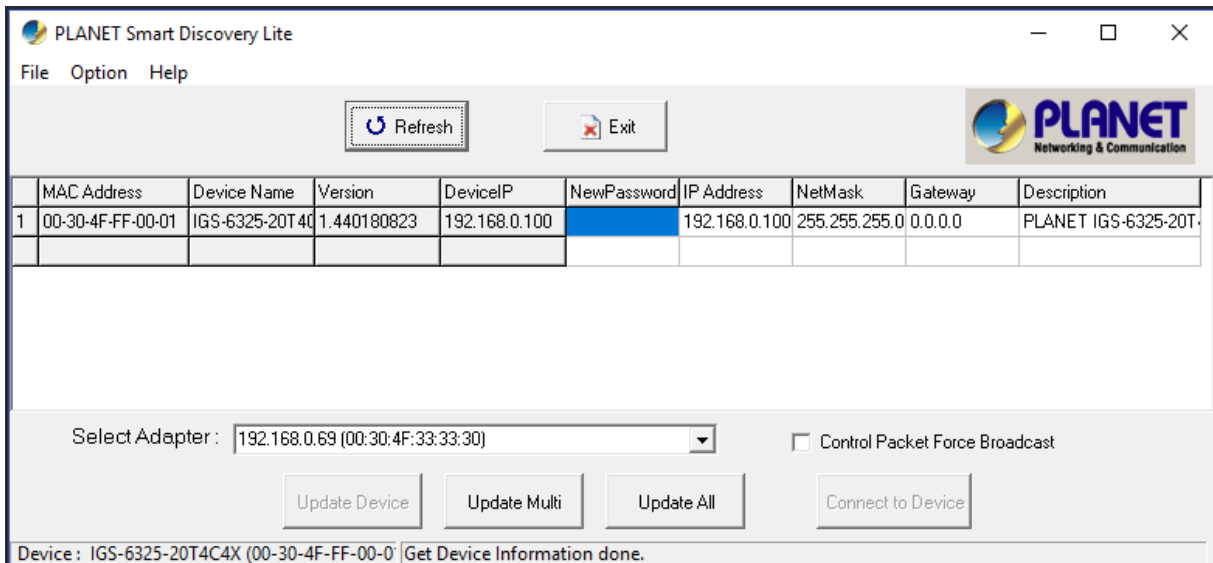

Figure 3-7: Planet Smart Discovery Utility Screen

1. This utility shows all the necessary information from the devices, such as MAC address, device name, firmware version and device IP subnet address. A new password, IP subnet address and description can be assigned to the devices.
2. After setup is completed, press the “**Update Device**”, “**Update Multi**” or “**Update All**” button to take effect. The functions of the 3 buttons above are shown below:
  - **Update Device:** Use the current setting on one single device.
  - **Update Multi:** Use the current setting on choose multi-devices.
  - **Update All:** Use the current setting on whole devices in the list.

The same functions mentioned above also can be found in “**Option**” tools bar.

3. To click the “**Control Packet Force Broadcast**” function, it allows new setting value to be assigned to the Web Smart Switch under a different IP subnet address.
4. Press the “**Connect to Device**” button and then the Web login screen appears in [Figure 3-7](#).
5. Press the “**Exit**” button to shut down Planet Smart Discovery Utility.

## 4. WEB CONFIGURATION

This section introduces the configuration and functions of the Web-based management.

### About Web-based Management

The **Industrial Managed Switch** offers management features that allow users to manage the **Industrial Managed Switch** from anywhere on the network through a standard browser such as Microsoft Internet Explorer.

The Web-based Management supports Internet Explorer 8.0. It is based on Java Applets with an aim to reducing network bandwidth consumption, enhancing access speed and presenting an easy viewing screen.



By default, IE7.0 or later version does not allow Java Applets to open sockets. The user has to explicitly modify the browser setting to enable Java Applets to use network ports.

The **Industrial Managed Switch** can be configured through an Ethernet connection, making sure the manager PC must be set to the same the IP subnet address as the **Industrial Managed Switch**. For example, the default IP address of the Industrial Managed Switch is 192.168.0.100, then the manager PC should be set to 192.168.0.x (where x is a number between 1 and 254, except 100), and the default subnet mask is 255.255.255.0.

If you have changed the default IP address of the **Industrial Managed Switch** to 192.168.1.1 with subnet mask 255.255.255.0 via console, then the manager PC should be set to 192.168.1.x (where x is a number between 2 and 254) to be able to do the related configuration on manager PC.

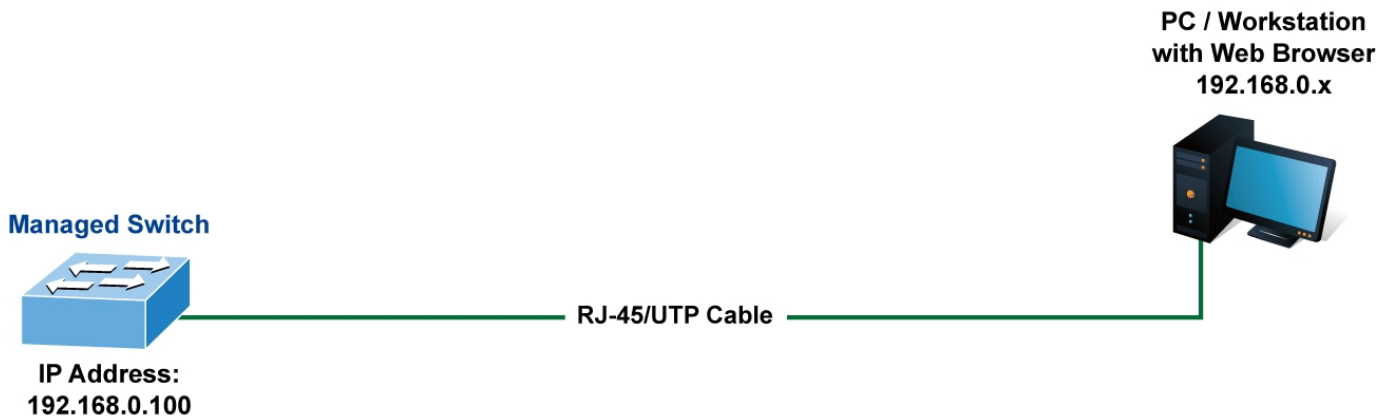

Figure 4-1-1: Web Management

#### ■ Logging on to the Industrial Managed Switch

1. Use Internet Explorer 7.0 or above Web browser. Enter the factory-default IP address to access the Web interface. The factory-default IP address is as follows:

**http://192.168.0.100**

2. When the following login screen appears, please enter the default username "**admin**" with password "**admin**" (or the username/password you have changed via console) to log in the main screen of **Industrial Managed Switch**. The login

screen in Figure 4-1-2 appears.

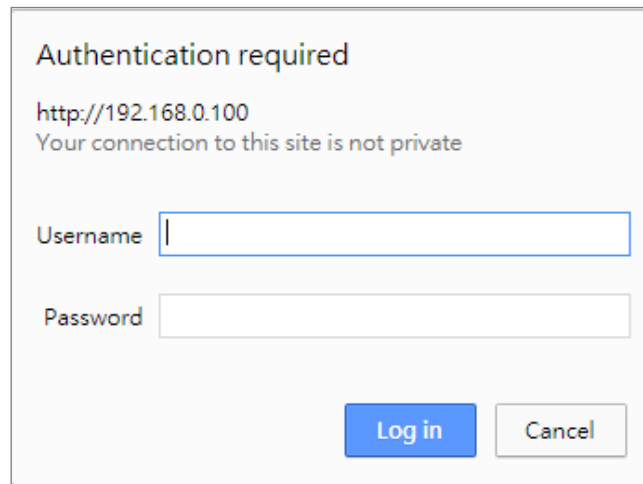

Figure 4-1-2: Login Screen

Default User name: **admin**  
Default Password: **admin**

After entering the username and password, the main screen appears as Figure 4-1-3.



Figure 4-1-3: Default Main Page

Now, you can use the Web management interface to continue the switch management or manage the **Industrial Managed Switch** by Web interface. The Switch Menu on the left of the web page lets you access all the commands and statistics the Industrial Managed Switch provides.



- 
1. It is recommended to use Internet Explorer 8.0 or above to access **Industrial Managed Switch**.
  2. The changed IP address takes effect immediately after clicking on the **Save** button. From now on, you need to use the new IP address to access the Internet.
- 



- 
3. For security reason, please change and memorize the new password after this first setup.
  4. Only accept command in lowercase letter.
-

## 4.1 Main Web page

The **Industrial Managed Switch** provides a Web-based browser interface for configuring and managing it. This interface allows you to access the **Industrial Managed Switch** using the Web browser of your choice. This chapter describes how to use the **Industrial Managed Switch's** Web browser interface to configure and manage it.



### Panel Display

The web agent displays an image of the **Industrial Managed Switch's** ports. The Mode can be set to display different information for the ports, including Link up or Link down. Clicking on the image of a port opens the **Port Statistics** page.

The port states are illustrated as follows:

State	Disabled	Down	Link
RJ45 Ports			
SFP Ports			

### Main Menu

Using the onboard web agent, you can define system parameters, manage and control the **Industrial Managed Switch**, and all its ports, or monitor network conditions. The Main Menu always contains one or more buttons, such as “**System**”, “**Switching**”, “**Routing**”, “**QoS**”, “**Security**”, “**PoE**”, “**Ring**”, “**ONVIF**” and “**Maintenance**”

Via the Web-Management, the administrator can set up the **Industrial Managed Switch** by selecting the functions listed in the Main Function. The screen in [Figure 4-1-5](#) appears.

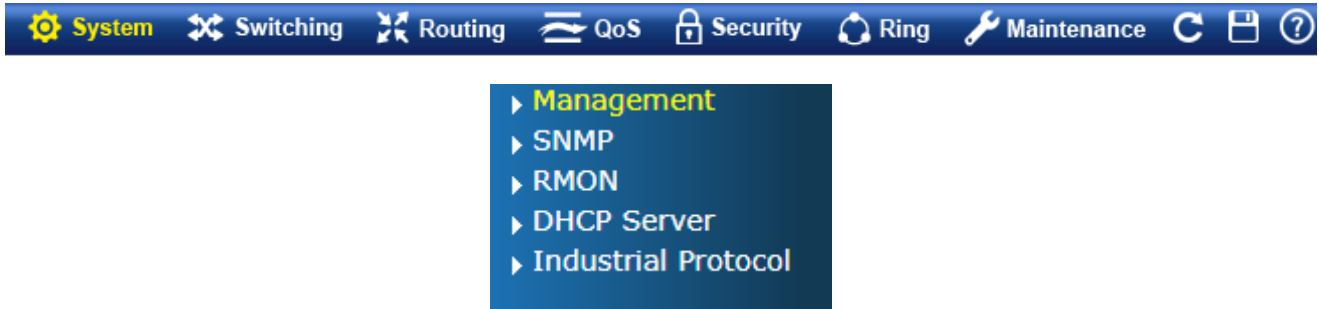

**Figure 4-1-5: Industrial Managed Switch Main Functions Menu**



## 4.2 System

Use the System menu items to display and configure basic administrative details of the **Industrial Managed Switch**. Under the System, the following topics are provided to configure and view the system information. This section has the following items:

- **System Information**      The **Industrial Managed Switch** system information is provided here.
- **IP Configuration**      Configure the IPv4/IPv6 interface and IP routes of the **Industrial Managed Switch** on this page.
- **IP Status**              This page displays the status of the IP protocol layer. The status is defined by the IP interfaces, the IP routes and the neighbor cache (ARP cache) status.
- **Users Configuration**    This page provides an overview of the current users. Currently the only way to login as another user on the web server is to close and reopen the browser.
  
- **Privilege Levels**        This page provides an overview of the privilege levels.
- **NTP Configuration**      Configure NTP server on this page.
- **Time Configuration**    Configure time parameter on this page.
- **UPnP**                    Configure UPnP on this page.
- **DHCP Relay**             Configure DHCP Relay on this page.
- **DHCP Relay Statistics**   This page provides statistics for DHCP relay.
- **CPU Load**              This page displays the CPU load, using an SVG graph.
- **System Log**             The system log information of the **Industrial Managed Switch** system is provided here.
  
- **Detailed Log**          The detailed log information of the **Industrial Managed Switch** system is provided here.
  
- **Remote Syslog**        Configure remote syslog on this page.
- **SMTP Configuration**    Configure SMTP parameters on this page.
- **Digital Input/Output**    Configure digital input and output on this page.
- **Fault Alarm**            Configure fault alarm on this page.
- **SNMP**                    Configure SNMP parameters on this page
- **RMON**                  Configure the RMON parameters on this page
- **DHCP server**            Configure the DHCP server on this page
- **Industrial Protocol**     Configure the Modbus TCP Mode on this page

## 4.2.1 Management

### 4.2.1.1 System Information

The System Information page provides information for the current device information. System Information page helps a switch administrator to identify the hardware MAC address, software version and system uptime. The screen in [Figure 4-2-1](#) appears.

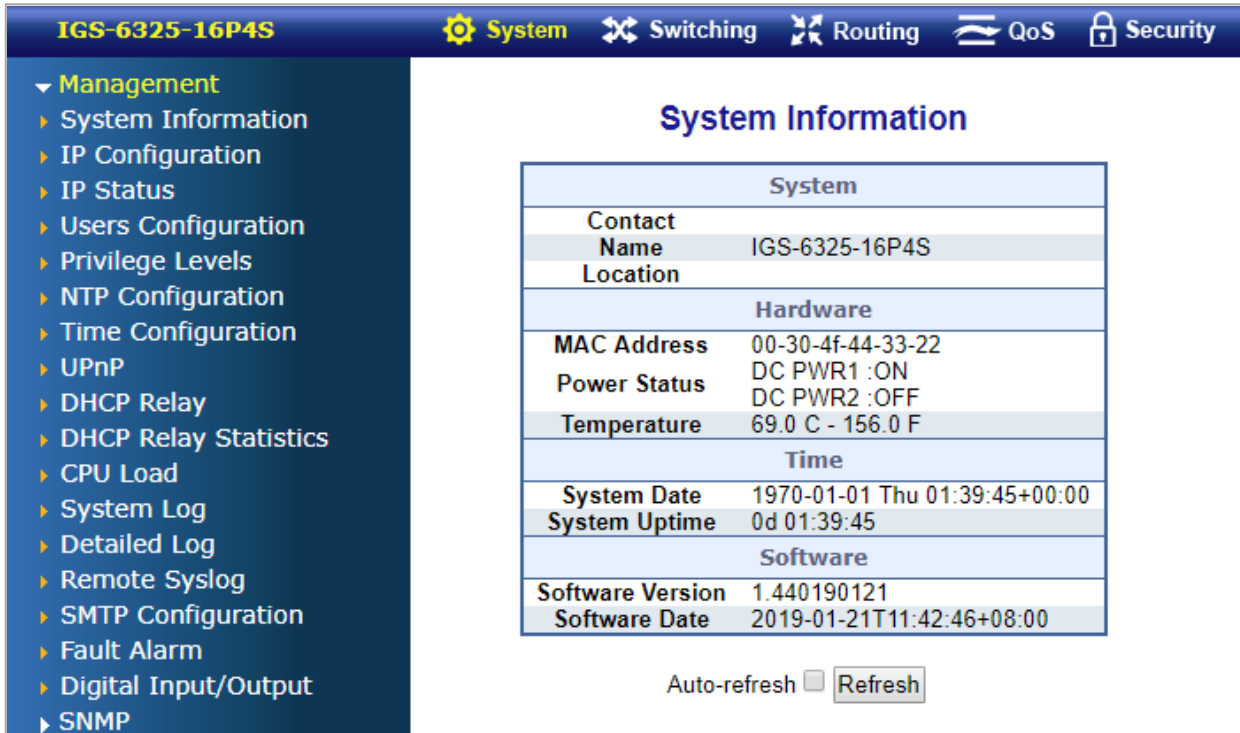

System	
<b>Contact</b>	
<b>Name</b>	IGS-6325-16P4S
<b>Location</b>	
Hardware	
<b>MAC Address</b>	00-30-4f-44-33-22
<b>Power Status</b>	DC PWR1 :ON DC PWR2 :OFF
<b>Temperature</b>	69.0 C - 156.0 F
Time	
<b>System Date</b>	1970-01-01 Thu 01:39:45+00:00
<b>System Uptime</b>	0d 01:39:45
Software	
<b>Software Version</b>	1.440190121
<b>Software Date</b>	2019-01-21T11:42:46+08:00

Auto-refresh

**Figure 4-2-1:** System Information Page Screenshot

The page includes the following fields:

Object	Description
• <b>Contact</b>	The system contact configured in SNMP   System Information   System Contact.
• <b>Name</b>	The system name configured in SNMP   System Information   System Name.
• <b>Location</b>	The system location configured in SNMP   System Information   System Location.
• <b>MAC Address</b>	The MAC Address of this <b>Industrial Managed Switch</b> .
• <b>Power Status</b>	The status of power input
• <b>Temperature</b>	Indicates chipset temperature.
• <b>System Date</b>	The current (GMT) system time and date. The system time is obtained through the configured NTP Server, if any.
• <b>System Uptime</b>	The period of time the device has been operational.
• <b>Software Version</b>	The software version of the <b>Industrial Managed Switch</b> .
• <b>Software Date</b>	The date when the <b>Industrial Managed Switch</b> software was produced.

#### Buttons

Auto-refresh : Check this box to refresh the page automatically. Automatic refresh occurs every 3 seconds.

### 4.2.1.2 IP Configuration

The IP Configuration includes the IP Configuration, IP Interface and IP Routes. The configured column is used to view or change the IP configuration. The maximum number of interfaces supported is 128 and the maximum number of routes is 128.

The screen in [Figure 4-2-2](#) appears.

#### IP Configuration

<b>Domain Name</b>	No Domain Name <span style="float: right;">▼</span>	<input style="width: 80%;" type="text"/>
<b>Mode</b>	Host <span style="float: right;">▼</span>	
<b>DNS Server</b>	No DNS server <span style="float: right;">▼</span>	<input style="width: 80%;" type="text"/>
<b>DNS Proxy</b>	<input type="checkbox"/>	

#### IP Interfaces

Delete	VLAN	Enable	DHCPv4					IPv4				
			Type	IfMac	ASCII	HEX	Hostname	Fallback	Current Lease	Address	Mask Length	
<input type="checkbox"/>	1	<input type="checkbox"/>	Auto	Port 1	<input type="text"/>	<input type="text"/>	<input type="text"/>	<input type="text"/>	0	<input type="text"/>	192.168.0.100	<input type="text" value="24"/>

DHCPv6			IPv6	
Enable	Rapid Commit	Current Lease	Address	Mask Length
<input type="checkbox"/>	<input type="checkbox"/>	<input type="text"/>	<input type="text"/>	<input type="text"/>

#### IP Routes

Delete	Network	Mask Length	Gateway	Next Hop VLAN
<input type="checkbox"/>	<input type="text"/>	<input type="text"/>	<input type="text"/>	<input type="text"/>

**Figure 4-2-2: IP Configuration Page Screenshot**

The current column is used to show the active IP configuration.

Object	Mode	Description
• IP Configurations	Mode	Configure whether the IP stack should act as a Host or a Router. In Host mode, IP traffic between interfaces will not be routed. In Router mode traffic is routed between all interfaces.
	DNS Server	This setting controls the DNS name resolution done by the switch. There are four servers available for configuration, and the index of the server presents the preference (less index has higher priority) in doing DNS name resolution.

		<p>System selects the active DNS server from configuration in turn, if the preferred server does not respond in five attempts.</p> <p>The following modes are supported:</p> <ul style="list-style-type: none"> <li>■ <b>No DNS server</b> No DNS server will be used.</li> <li>■ <b>Configured IPv4</b> Explicitly provide the valid IPv4 unicast address of the DNS Server in dotted decimal notation. Make sure the configured DNS server could be reachable (e.g. via PING) for activating DNS service.</li> <li>■ <b>Configured IPv6</b> Explicitly provide the valid IPv6 unicast (except link local) address of the DNS Server. Make sure the configured DNS server could be reachable (e.g. via PING6) for activating DNS service.</li> <li>■ <b>From any DHCPv4 interfaces</b> The first DNS server offered from a DHCPv4 lease to a DHCPv4-enabled interface will be used.</li> <li>■ <b>From this DHCPv4 interface</b> Specify from which DHCPv4-enabled interface a provided DNS server should be preferred.</li> <li>■ <b>From any DHCPv6 interfaces</b> The first DNS server offered from a DHCPv6 lease to a DHCPv6-enabled interface will be used.</li> <li>■ <b>From this DHCPv6 interface</b> Specify from which DHCPv6-enabled interface a provided DNS server should be preferred</li> </ul>		
	<b>DNS Proxy</b>	When DNS proxy is enabled, system will relay DNS requests to the currently configured DNS server, and reply as a DNS resolver to the client devices on the network.		
<ul style="list-style-type: none"> <li>• <b>IP Interface</b></li> </ul>	<b>Delete</b>	Select this option to delete an existing IP interface.		
	<b>VLAN</b>	The VLAN associated with the IP interface. Only ports in this VLAN will be able to access the IP interface. This field is only available for input when creating a new interface.		
	<b>DHCPv4</b>	<table border="1"> <tr> <td data-bbox="507 1850 691 2040"><b>Enabled</b></td> <td data-bbox="691 1850 1495 2040">Enable the DHCPv4 client by checking this box. If this option is enabled, the system will configure the IPv4 address and mask of the interface using the DHCPv4 protocol. The DHCPv4 client will announce the configured System Name as hostname to provide DNS lookup.</td> </tr> </table>	<b>Enabled</b>	Enable the DHCPv4 client by checking this box. If this option is enabled, the system will configure the IPv4 address and mask of the interface using the DHCPv4 protocol. The DHCPv4 client will announce the configured System Name as hostname to provide DNS lookup.
<b>Enabled</b>	Enable the DHCPv4 client by checking this box. If this option is enabled, the system will configure the IPv4 address and mask of the interface using the DHCPv4 protocol. The DHCPv4 client will announce the configured System Name as hostname to provide DNS lookup.			
	<b>Fallback</b>	The number of seconds for trying to obtain a DHCP lease. After this		

			period expires, a configured IPv4 address will be used as IPv4 interface address. A value of zero disables the fallback mechanism, such that DHCP will keep retrying until a valid lease is obtained. Legal values are 0 to 4294967295 seconds.
		<b>Current Lease</b>	For DHCP interfaces with an active lease, this column shows the current interface address, as provided by the DHCP server.
<b>IPv4</b>	<b>Address</b>		The IPv4 address of the interface in dotted decimal notation. If DHCP is enabled, this field configures the fallback address. The field may be left blank if IPv4 operation on the interface is not desired - or no DHCP fallback address is desired.
	<b>Mask Length</b>		The IPv4 network mask, in number of bits (prefix length). Valid values are between 0 and 30 bits for an IPv4 address. If DHCP is enabled, this field configures the fallback address network mask. The field may be left blank if IPv4 operation on the interface is not desired - or no DHCP fallback address is desired.
<b>DHCPv6</b>	<b>Enable</b>		Enable the DHCPv6 client by checking this box. If this option is enabled, the system will configure the IPv6 address of the interface using the DHCPv6 protocol.
	<b>Rapid Commit</b>		Enable the DHCPv6 Rapid-Commit option by checking this box. If this option is enabled, the DHCPv6 client terminates the waiting process as soon as a Reply message with a Rapid Commit option is received. This option is only manageable when DHCPv6 client is enabled.
	<b>Current Lease</b>		For DHCPv6 interface with an active lease, this column shows the interface address provided by the DHCPv6 server.
<b>IPv6</b>	<b>Address</b>		The IPv6 address of the interface. An IPv6 address is in 128-bit records represented as eight fields of up to four hexadecimal digits with a colon separating each field (:). For example, fe80::215:c5ff:fe03:4dc7. The symbol :: is a special syntax that can be used as a shorthand way of representing multiple 16-bit groups of contiguous zeros; but it can appear only once.  System accepts the valid IPv6 unicast address only, except IPv4-Compatible address and IPv4-Mapped address.  The field may be left blank if IPv6 operation on the interface is not desired.
	<b>Mask Length</b>		The IPv6 network mask, in number of bits (prefix length). Valid values are between 1 and 128 bits for an IPv6 address.  The field may be left blank if IPv6 operation on the interface is not desired.
• <b>IP Routes</b>	<b>Delete</b>		Select this option to delete an existing IP route.
	<b>Network</b>		The destination IP network or host address of this route. Valid format is

		dotted decimal notation or a valid IPv6 notation. A default route can use the value 0.0.0.0 or IPv6 :: notation.
	<b>Mask Length</b>	The destination IP network or host mask, in number of bits (prefix length). It defines how much of a network address that must match, in order to qualify for this route. Valid values are between 0 and 32 bits respectively 128 for IPv6 routes. Only a default route will have a mask length of 0 (as it will match anything).
	<b>Gateway</b>	The IP address of the IP gateway. Valid format is dotted decimal notation or a valid IPv6 notation. Gateway and Network must be of the same type.
	<b>Next Hop VLAN</b>	The VLAN ID (VID) of the specific IPv6 interface associated with the gateway.  The given VID ranges from 1 to 4095 and will be effective only when the corresponding IPv6 interface is valid.  If the IPv6 gateway address is link-local, it must specify the next hop.

**Buttons**

**Add Interface** : Click to add a new IP interface. A maximum of 128 interfaces are supported.

**Add Route** : Click to add a new IP route. A maximum of 32 routes are supported.

**Apply** : Click to apply changes.

**Reset** : Click to undo any changes made locally and revert to previously saved values.

### 4.2.1.3 IP Status

IP Status displays the status of the IP protocol layer. The status is defined by the IP interfaces, the IP routes and the neighbor cache (ARP cache) status. The screen in [Figure 4-2-3](#) appears.

IP Interfaces			
Interface	Type	Address	Status
OS:lo	LINK	00-00-00-00-00-00	<UP LOOPBACK RUNNING MULTICAST>
OS:lo	IPv4	127.0.0.1/8	
OS:lo	IPv6	fe80:1::1/64	
OS:lo	IPv6	::1/128	
VLAN1	LINK	00-30-4f-11-22-33	<UP BROADCAST RUNNING MULTICAST>
VLAN1	IPv4	192.168.0.100/20	
VLAN1	IPv6	fe80:2::230:4fff:fe11:2233/64	

IP Routes		
Network	Gateway	Status
127.0.0.1/32	127.0.0.1	<UP HOST>
192.168.0.0/24	VLAN1	<UP HW_RT>
192.168.0.0/20	VLAN1	<UP HW_RT>
224.0.0.0/4	127.0.0.1	<UP>
::1/128	::1	<UP HOST>

Neighbour cache	
IP Address	Link Address
192.168.0.123	VLAN1:00-30-4f-91-e6-45
fe80:2::230:4fff:fe11:2233	VLAN1:00-30-4f-11-22-33

Figure 4-2-3: IP Status Page Screenshot

The page includes the following fields:

Object	Description	
• IP Interfaces	Interface	The name of the interface.
	Type	The address type of the entry. This may be <b>LINK</b> or <b>IPv4</b> .
	Address	The current address of the interface (of the given type).
	Status	The status flags of the interface (and/or address).
• IP Routes	Network	The destination IP network or host address of this route.
	Gateway	The gateway address of this route.
	Status	The status flags of the route.
• Neighbor Cache	IP Address	The IP address of the entry.
	Link Address	The Link (MAC) address for which a binding to the IP address given exists.

#### Buttons

Auto-refresh  : Check this box to refresh the page automatically. Automatic refresh occurs every 3 seconds.

: Click to refresh the page.

#### 4.2.1.4 Users Configuration

This page provides an overview of the current users. Currently the only way to log in as another user on the web server is to close and reopen the browser. After setup is completed, press the “**Apply**” button to take effect. Please login web interface with new user name and password; the screen in [Figure 4-2-4](#) appears.

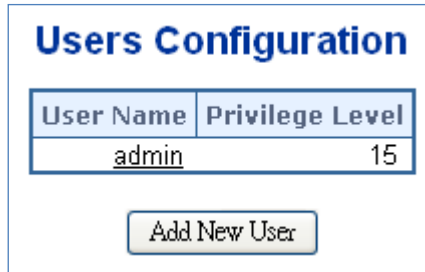

Figure 4-2-4: Users Configuration Page Screenshot

The page includes the following fields:

Object	Description
<ul style="list-style-type: none"> <li>• <b>User Name</b></li> </ul>	The name identifying the user. This is also a link to Add/Edit User.
<ul style="list-style-type: none"> <li>• <b>Privilege Level</b></li> </ul>	<p>The privilege level of the user.</p> <p>The allowed range is <b>0</b> to <b>15</b>. If the privilege level value is 15, it can access all groups, i.e. that is granted the full control of the device. But other values need to refer to each group privilege level. User's privilege should be the same or greater than the group privilege level to have the access to that group.</p> <p>By default setting, most groups privilege level 5 has the read-only access and privilege level 10 has the read-write access. And the system maintenance (software upload, factory defaults and etc.) needs user privilege level 15.</p> <p>Generally, the privilege level 15 can be used for an administrator account, privilege level 10 for a standard user account and privilege level 5 for a guest account.</p>

#### Buttons

: Click to add a new user.



### Add / Edit User

This page configures a user – add, edit or delete user.

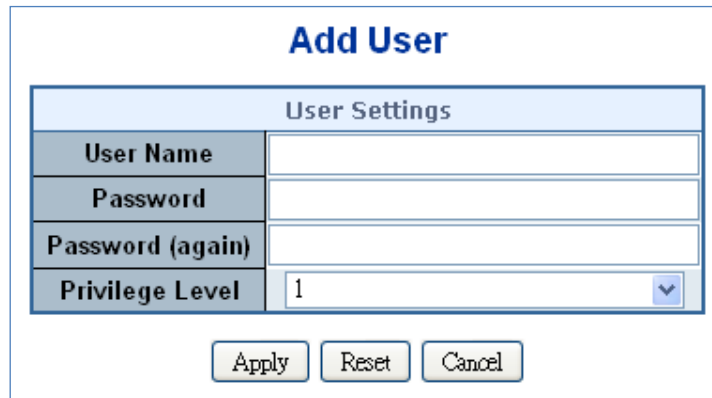

Figure 4-2-5: Add / Edit User Configuration Page Screenshot

The page includes the following fields:

Object	Description
• Username	A string identifying the user name that this entry should belong to. The allowed string length is <b>1</b> to <b>31</b> . The valid user name is a combination of letters, numbers and underscores.
• Password	The password of the user. The allowed string length is <b>0</b> to <b>31</b> .
• Password (again)	Please enter the user's new password here again to confirm.
• Privilege Level	<p>The privilege level of the user.</p> <p>The allowed range is <b>0</b> to <b>15</b>. If the privilege level value is 15, it can access all groups, i.e. that is granted the fully control of the device. But others value need to refer to each group privilege level. User's privilege should be same or greater than the group privilege level to have the access of that group.</p> <p>By default setting, most groups privilege level 5 has the read-only access and privilege level 10 has the read-write access. And the system maintenance (software upload, factory defaults and etc.) needs user privilege level 15.</p> <p>Generally, the privilege level 15 can be used for an administrator account, privilege level 10 for a standard user account and privilege level 5 for a guest account.</p>

#### Buttons

**Apply**: Click to apply changes.

**Reset**: Click to undo any changes made locally and revert to previously saved values.

**Cancel**: Click to undo any changes made locally and return to the Users.

: Delete the current user. This button is not available for new configurations (Add new user).

Once the new user is added, the new user entry is shown on the Users Configuration page.

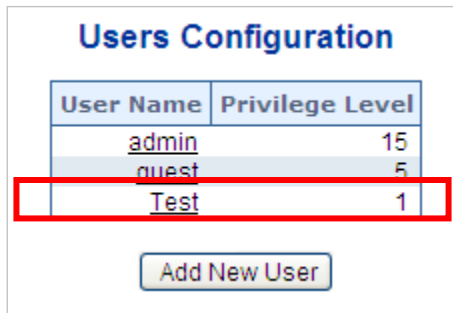

User Name	Privilege Level
admin	15
guest	5
Test	1



Figure 4-2-6: User Configuration Page Screenshot



If you forget the new password after changing the default password, please press the **“Reset”** button on the front panel of the Industrial Managed Switch for over 10 seconds and then release it. The current setting including VLAN will be lost and the Industrial Managed Switch will restore to the default mode.

### 4.2.1.5 Privilege Levels

This page provides an overview of the privilege levels. After setup is completed, please press the “Apply” button to take effect. Please log in web interface with new user name and password and the screen in [Figure 4-2-7](#) appears.

### Privilege Level Configuration

Group Name	Privilege Levels			
	Configuration Read-only	Configuration/Execute Read/write	Status/Statistics Read-only	Status/Statistics Read/write
Aggregation	5 ▼	10 ▼	5 ▼	10 ▼
DHCP_Client	5 ▼	10 ▼	5 ▼	10 ▼
Diagnostics	5 ▼	10 ▼	5 ▼	10 ▼
DIDO	5 ▼	10 ▼	5 ▼	10 ▼
ERPS	5 ▼	10 ▼	5 ▼	10 ▼
IPMC_Snooping	5 ▼	10 ▼	5 ▼	10 ▼
LACP	5 ▼	10 ▼	5 ▼	10 ▼
LLDP	5 ▼	10 ▼	5 ▼	10 ▼
Loop_Protect	5 ▼	10 ▼	5 ▼	10 ▼
MAC_Table	5 ▼	10 ▼	5 ▼	10 ▼
Maintenance	15 ▼	15 ▼	15 ▼	15 ▼
MEP	5 ▼	10 ▼	5 ▼	10 ▼
Mirroring	5 ▼	10 ▼	5 ▼	10 ▼
MVR	5 ▼	10 ▼	5 ▼	10 ▼
NTP	5 ▼	10 ▼	5 ▼	10 ▼
Ports	5 ▼	10 ▼	1 ▼	10 ▼
Private_VLANs	5 ▼	10 ▼	5 ▼	10 ▼
QoS	5 ▼	10 ▼	5 ▼	10 ▼
Security	5 ▼	10 ▼	5 ▼	10 ▼
Spanning_Tree	5 ▼	10 ▼	5 ▼	10 ▼
System	5 ▼	10 ▼	1 ▼	10 ▼
UPnP	5 ▼	10 ▼	5 ▼	10 ▼
VLAN_Translation	5 ▼	10 ▼	5 ▼	10 ▼
VLANs	5 ▼	10 ▼	5 ▼	10 ▼
Voice_VLAN	5 ▼	10 ▼	5 ▼	10 ▼

**Figure 4-2-7:** Privilege Levels Configuration Page Screenshot

The page includes the following fields:

Object	Description
<ul style="list-style-type: none"> <li>• <b>Group Name</b></li> </ul>	<p>The name identifying the privilege group. In most cases, a privilege level group consists of a single module (e.g. LACP, RSTP or QoS), but a few of them contain</p>

	<p>more than one. The following description defines these privilege level groups in details:</p> <ul style="list-style-type: none"> <li>■ <b>System:</b> Contact, Name, Location, Timezone, Log.</li> <li>■ <b>Security:</b> Authentication, System Access Management, Port (contains Dot1x port, MAC based and the MAC Address Limit), ACL, HTTPS, SSH, ARP Inspection and IP source guard.</li> <li>■ <b>IP:</b> Everything except 'ping'.</li> <li>■ <b>Port:</b> Everything except 'VeriPHY'.</li> <li>■ <b>Diagnostics:</b> 'ping' and 'VeriPHY'.</li> <li>■ <b>Maintenance:</b> CLI- System Reboot, System Restore Default, System Password, Configuration Save, Configuration Load and Firmware Load. Web- Users, Privilege Levels and everything in Maintenance.</li> <li>■ <b>Debug:</b> Only present in CLI.</li> </ul>
<ul style="list-style-type: none"> <li>• <b>Privilege Level</b></li> </ul>	<p>Every privilege level group has an authorization level for the following sub groups:</p> <ul style="list-style-type: none"> <li>■ <b>Configuration read-only</b></li> <li>■ <b>Configuration/execute read-write</b></li> <li>■ <b>Status/statistics read-only</b></li> <li>■ <b>Status/statistics read-write</b> (e.g. for clearing of statistics).</li> </ul> <p>User Privilege should be same or greater than the authorization Privilege level to have the access to that group.</p>

**Buttons**

 : Click to apply changes.

 : Click to undo any changes made locally and revert to previously saved values.

### 4.2.1.6 NTP Configuration

Configure NTP on this page. **NTP** is an acronym for **Network Time Protocol**, a network protocol for synchronizing the clocks of computer systems. NTP uses UDP (data grams) as transport layer. You can specify NTP Servers. The NTP Configuration screen in [Figure 4-2-8](#) appears.

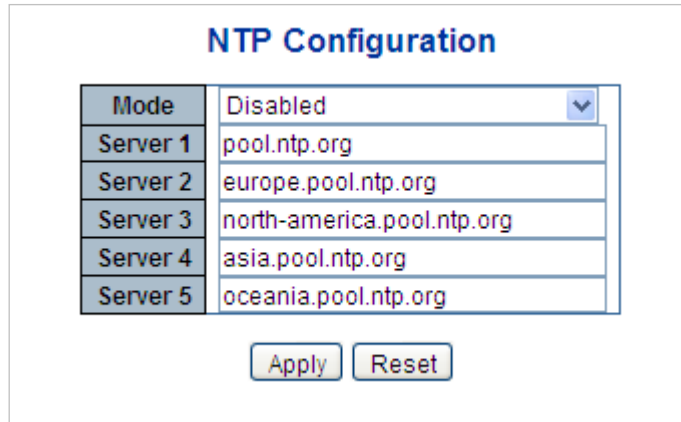

**Figure 4-2-8:** NTP Configuration Page Screenshot

The page includes the following fields:

Object	Description
<ul style="list-style-type: none"> <li>• <b>Mode</b></li> </ul>	<p>Indicates the NTP mode operation. Possible modes are:</p> <ul style="list-style-type: none"> <li>■ <b>Enabled:</b> Enable NTP mode operation. When enabling NTP mode operation, the agent forward and transfer NTP messages between the clients and the server when they are not on the same subnet domain.</li> <li>■ <b>Disabled:</b> Disable NTP mode operation.</li> </ul>
<ul style="list-style-type: none"> <li>• <b>Server #</b></li> </ul>	<p>Provide the NTP IPv4 or IPv6 address of this switch. IPv6 address is in 128-bit records represented as eight fields of up to four hexadecimal digits with a colon separating each field (:).</p> <p>For example, 'fe80::215:c5ff:fe03:4dc7'. The symbol '::' is a special syntax that can be used as a shorthand way of representing multiple 16-bit groups of contiguous zeros, but it can only appear once. It also uses a legal IPv4 address like '::192.1.2.34'.</p>

#### Buttons

: Click to apply changes.

: Click to undo any changes made locally and revert to previously saved values.

#### 4.2.1.6.1 System Time Correction Manually

Configure NTP on this page. **NTP** is an acronym for **Network Time Protocol**, a network protocol for synchronizing the clocks of computer systems. NTP uses UDP (data grams) as transport layer. You can specify NTP Servers. The NTP Configuration screen in [Figure 4-2-9](#) appears.

### System Time Correction Manually

<b>User Manually</b>	<input type="checkbox"/> Enable	
<b>Year</b>	1970	(1970 ~ 2037)
<b>Month</b>	1	(1 ~ 12)
<b>Day</b>	1	(1 ~ 31)
<b>Hour</b>	0	(0 ~ 23)
<b>Minute</b>	0	(0 ~ 59)
<b>Second</b>	0	(0 ~ 59)

**Figure 4-2-9:** System Time Correction Manually Page Screenshot

The page includes the following fields:

Object	Description
<ul style="list-style-type: none"> <li>• <b>User Manually</b></li> </ul>	<p>Indicates the NTP mode as manual operation. Possible modes are:</p> <ul style="list-style-type: none"> <li>■ <b>Enabled:</b> Enable NTP manual mode operation. When enabling NTP user manually mode operation, the system time will follow the date setting.</li> <li>■ <b>Disabled:</b> Disable NTP user manual mode operation.</li> </ul>
<ul style="list-style-type: none"> <li>• <b>Date</b></li> </ul>	<p>Switch can set the Year/Mouth/Day/Hour/Minute/Second on this page</p>

#### Buttons

: Click to apply changes.

: Click to undo any changes made locally and revert to previously saved values.

### 4.2.1.7 Time Configuration

Configure Time Zone on this page. A **Time Zone** is a region that has a uniform standard time for legal, commercial, and social purposes. It is convenient for areas in close commercial or other communication to keep the same time, so time zones tend to follow the boundaries of countries and their subdivisions. The Time Zone Configuration screen in Figure 4-2-10 appears

## Time Zone Configuration

Time Zone Configuration	
Time Zone	(UTC) Coordinated Universal Time ▼
Hours	0 ▼
Minutes	0 ▼
Acronym	<input type="text"/> ( 0 - 16 characters )

## Daylight Saving Time Configuration

**Daylight Saving Time Mode**

Daylight Saving Time Disabled ▼

Start Time Settings	
Month	Jan ▼
Date	1 ▼
Year	2014 ▼
Hours	0 ▼
Minutes	0 ▼

End Time Settings	
Month	Jan ▼
Date	1 ▼
Year	2097 ▼
Hours	0 ▼
Minutes	0 ▼

Offset Settings	
Offset	<input type="text" value="1"/> (1 - 1439) Minutes

Figure 4-2-10: Time Configuration Page Screenshot

The page includes the following fields:

Object	Description
<ul style="list-style-type: none"> <li>• <b>Time Zone</b></li> </ul>	Lists various Time Zones worldwide. Select appropriate Time Zone from the drop-down and click Save to set.
<ul style="list-style-type: none"> <li>• <b>Acronym</b></li> </ul>	User can set the acronym of the time zone. This is a User configurable acronym to identify the time zone. ( Range: Up to 16 characters )

<ul style="list-style-type: none"> <li>• <b>Daylight Saving Time</b></li> </ul>	<p>This is used to set the clock forward or backward according to the configurations set below for a defined Daylight Saving Time duration. Select 'Disable' to disable the Daylight Saving Time configuration. Select 'Recurring' and configure the Daylight Saving Time duration to repeat the configuration every year. Select 'Non-Recurring' and configure the Daylight Saving Time duration for single time configuration. ( Default: Disabled ).</p>
<ul style="list-style-type: none"> <li>• <b>Start Time Settings</b></li> </ul>	<ul style="list-style-type: none"> <li>• <b>Week</b> - Select the starting week number.</li> <li>• <b>Day</b> - Select the starting day.</li> <li>• <b>Month</b> - Select the starting month.</li> <li>• <b>Hours</b> - Select the starting hour.</li> <li>• <b>Minutes</b> - Select the starting minute.</li> </ul>
<ul style="list-style-type: none"> <li>• <b>End Time Settings</b></li> </ul>	<ul style="list-style-type: none"> <li>• <b>Week</b> - Select the ending week number.</li> <li>• <b>Day</b> - Select the ending day.</li> <li>• <b>Month</b> - Select the ending month.</li> <li>• <b>Hours</b> - Select the ending hour.</li> <li>• <b>Minutes</b> - Select the ending minute</li> </ul>
<ul style="list-style-type: none"> <li>• <b>Offset Settings</b></li> </ul>	<p>Enter the number of minutes to add during Daylight Saving Time. ( Range: 1 to 1440 )</p>

**Buttons**

 : Click to apply changes.

 : Click to undo any changes made locally and revert to previously saved values.



#### 4.2.1.8 UPnP

Configure UPnP on this page. UPnP is an acronym for **Universal Plug and Play**. The goals of UPnP are to allow devices to connect seamlessly and to simplify the implementation of networks in the home (data sharing, communications, and entertainment) and in corporate environments for simplified installation of computer components. The UPnP Configuration screen in [Figure 4-2-11](#) appears.

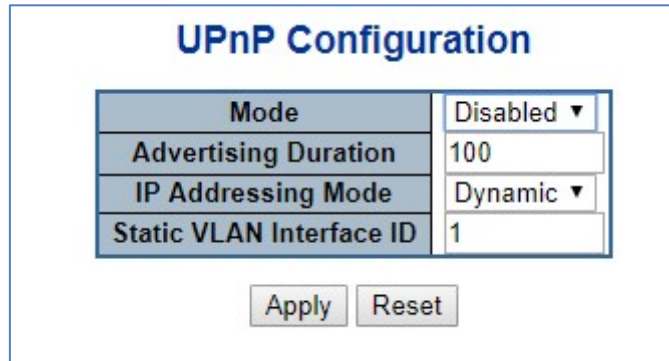

Figure 4-2-11: UPnP Configuration Page Screenshot

The page includes the following fields:

Object	Description
<ul style="list-style-type: none"> <li>• <b>Mode</b></li> </ul>	<p>Indicates the UPnP operation mode. Possible modes are:</p> <ul style="list-style-type: none"> <li>■ <b>Enabled</b>: Enable UPnP mode operation.</li> <li>■ <b>Disabled</b>: Disable UPnP mode operation.</li> </ul> <p>When the mode is enabled, two ACEs are added automatically to trap UPnP related packets to CPU. The ACEs are automatically removed when the mode is disabled.</p>
<ul style="list-style-type: none"> <li>• <b>Advertising Duration</b></li> </ul>	<p>The duration, carried in SSDP packets, is used to inform a control point or control points how often it or they should receive a SSDP advertisement message from this switch. If a control point does not receive any message within the duration, it will think that the switch no longer exists. Due to the unreliable nature of UDP, in the standard it is recommended that such refreshing of advertisements to be done at less than one-half of the advertising duration. In the implementation, the switch sends SSDP messages periodically at the interval one-half of the advertising duration minus 30 seconds. Valid values are in the range 100 to 86400.</p>
<ul style="list-style-type: none"> <li>• <b>IP Addressing Mode</b></li> </ul>	<p>IP addressing mode provides two ways to determine IP address assignment:</p> <ul style="list-style-type: none"> <li><b>Dynamic</b>: Default selection for UPnP. UPnP module helps users choosing the IP address of the switch device. It finds the first available system IP address.</li> <li><b>Static</b>: User specifies the IP interface VLAN for choosing the IP address of the switch device.</li> </ul>
<ul style="list-style-type: none"> <li>• <b>Static VLAN Interface</b></li> </ul>	<p>The index of the specific IP VLAN interface. It will only be applied when IP</p>

ID	Addressing Mode is static. Valid configurable values ranges from 1 to 4095. Default value is 1.
----	--

**Buttons**

: Click to apply changes

: Click to undo any changes made locally and revert to previously saved values.

**4.2.1.9 DHCP Relay**

Configure DHCP Relay on this page. **DHCP Relay** is used to forward and transfer DHCP messages between the clients and the server when they are not on the same subnet domain.

The **DHCP option 82** enables a DHCP relay agent to insert specific information into a DHCP request packets when forwarding client DHCP packets to a DHCP server and remove the specific information from a DHCP reply packets when forwarding server DHCP packets to a DHCP client. The DHCP server can use this information to implement IP address or other assignment policies. Specifically the option works by setting two sub-options:

- **Circuit ID (option 1)**
- **Remote ID (option 2)**

The **Circuit ID** sub-option is supposed to include information specific to which circuit the request came in on.

The **Remote ID** sub-option was designed to carry information relating to the remote host end of the circuit.

The definition of Circuit ID in the switch is 4 bytes in length and the format is "vlan\_id" "module\_id" "port\_no". The parameter of "vlan\_id" is the first two bytes representing the VLAN ID. The parameter of "module\_id" is the third byte for the module ID. The parameter of "port\_no" is the fourth byte and it means the port number.

The Remote ID is 6 bytes in length, and the value equals the DHCP relay agent's MAC address. The DHCP Relay Configuration screen in [Figure 4-2-12](#) appears.

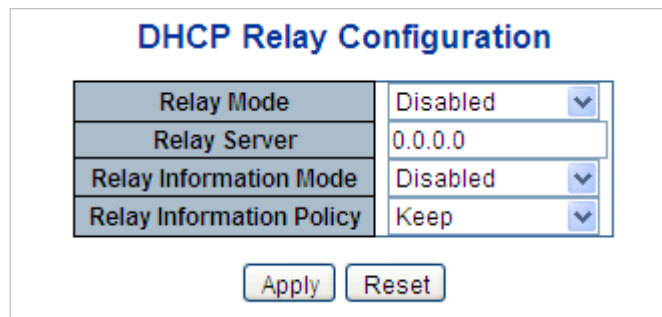

**Figure 4-2-12** DHCP Relay Configuration Page Screenshot

The page includes the following fields:

Object	Description
<ul style="list-style-type: none"> <li>• <b>Relay Mode</b></li> </ul>	<p>Indicates the DHCP relay mode operation. Possible modes are:</p> <ul style="list-style-type: none"> <li>■ <b>Enabled</b>: Enable DHCP relay mode operation. When enabling DHCP relay mode operation, the agent forwards and transfers DHCP messages between the clients and the server when they are not on the same subnet domain. And the DHCP broadcast message won't flood for security considered.</li> <li>■ <b>Disabled</b>: Disable DHCP relay mode operation.</li> </ul>
<ul style="list-style-type: none"> <li>• <b>Relay Server</b></li> </ul>	<p>Indicates the DHCP relay server IP address. A DHCP relay agent is used to forward and transfer DHCP messages between the clients and the server when they are not on the same subnet domain.</p>
<ul style="list-style-type: none"> <li>• <b>Relay Information Mode</b></li> </ul>	<p>Indicates the DHCP relay information mode option operation. Possible modes are:</p> <ul style="list-style-type: none"> <li>■ <b>Enabled</b>: Enable DHCP relay information mode operation. When enabling DHCP relay information mode operation, the agent inserts specific information (option82) into a DHCP message when forwarding to DHCP server and removing it from a DHCP message when transferring to DHCP client. It only works under DHCP relay operation mode enabled.</li> <li>■ <b>Disabled</b>: Disable DHCP relay information mode operation.</li> </ul>
<ul style="list-style-type: none"> <li>• <b>Relay Information Policy</b></li> </ul>	<p>Indicates the DHCP relay information option policy. When enabling DHCP relay information mode operation, if agent receives a DHCP message that already contains relay agent information. It will enforce the policy. And it only works under DHCP relay information operation mode enabled. Possible policies are:</p> <ul style="list-style-type: none"> <li>■ <b>Replace</b>: Replace the original relay information when receiving a DHCP message that already contains it.</li> <li>■ <b>Keep</b>: Keep the original relay information when receiving a DHCP message that already contains it.</li> <li>■ <b>Drop</b>: Drop the package when receiving a DHCP message that already contains relay information.</li> </ul>

**Buttons**

 : Click to apply changes

 : Click to undo any changes made locally and revert to previously saved values.

#### 4.2.1.10 DHCP Relay Statistics

This page provides statistics for DHCP relay. The DHCP Relay Statistics screen in [Figure 4-2-13](#) appears.

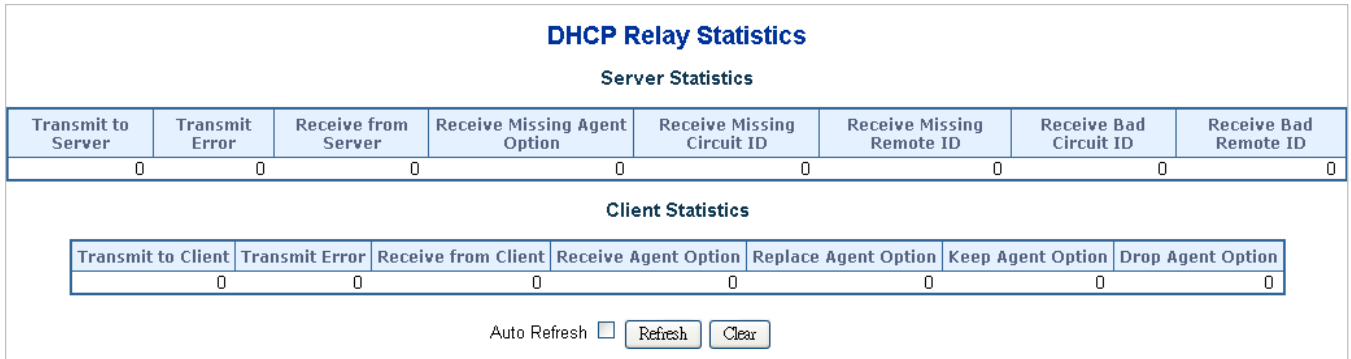

**Figure 4-2-13: DHCP Relay Statistics Page Screenshot**

The page includes the following fields:

#### Server Statistics

Object	Description
• <b>Transmit to Server</b>	The packets number that relayed from client to server.
• <b>Transmit Error</b>	The packets number that erroneously sent packets to clients.
• <b>Receive from Server</b>	The packets number that received packets from server.
• <b>Receive Missing Agent Option</b>	The packets number that received packets without agent information options.
• <b>Receive Missing Circuit ID</b>	The packets number that received packets whose the Circuit ID option was missing.
• <b>Receive Missing Remote ID</b>	The packets number that received packets whose Remote ID option was missing.
• <b>Receive Bad Circuit ID</b>	The packets number whose the Circuit ID option did not match known circuit ID.
<b>Receive Bad Remote ID</b>	The packets number whose the Remote ID option did not match known Remote ID.

**Client Statistics**

Object	Description
• <b>Transmit to Client</b>	The packets number that relayed packets from server to client.
• <b>Transmit Error</b>	The packets number that erroneously sent packets to servers.
• <b>Receive from Client</b>	The packets number that received packets from server.
• <b>Receive Agent Option</b>	The packets number that received packets with relay agent information option.
• <b>Replace Agent Option</b>	The packets number that replaced received packets with relay agent information option.
• <b>Keep Agent Option</b>	The packets number that kept received packets with relay agent information option.
• <b>Drop Agent Option</b>	The packets number that dropped received packets with relay agent information option.

**Buttons**

Auto-refresh  : Check this box to refresh the page automatically. Automatic refresh occurs every 3 seconds.

: Click to refresh the page immediately.

: Clears all statistics.

#### 4.2.1.11 CPU Load

This page displays the CPU load, using an SVG graph. The load is measured as average over the last 100ms, 1 sec and 10 seconds intervals. The last 120 samples are graphed, and the last numbers are displayed as text as well. In order to display the SVG graph, your browser must support the SVG format. Consult the SVG Wiki for more information on browser support. Specifically, at the time of writing, Microsoft Internet Explorer will need to have a plugin installed to support SVG. The CPU Load screen in [Figure 4-2-14](#) appears.

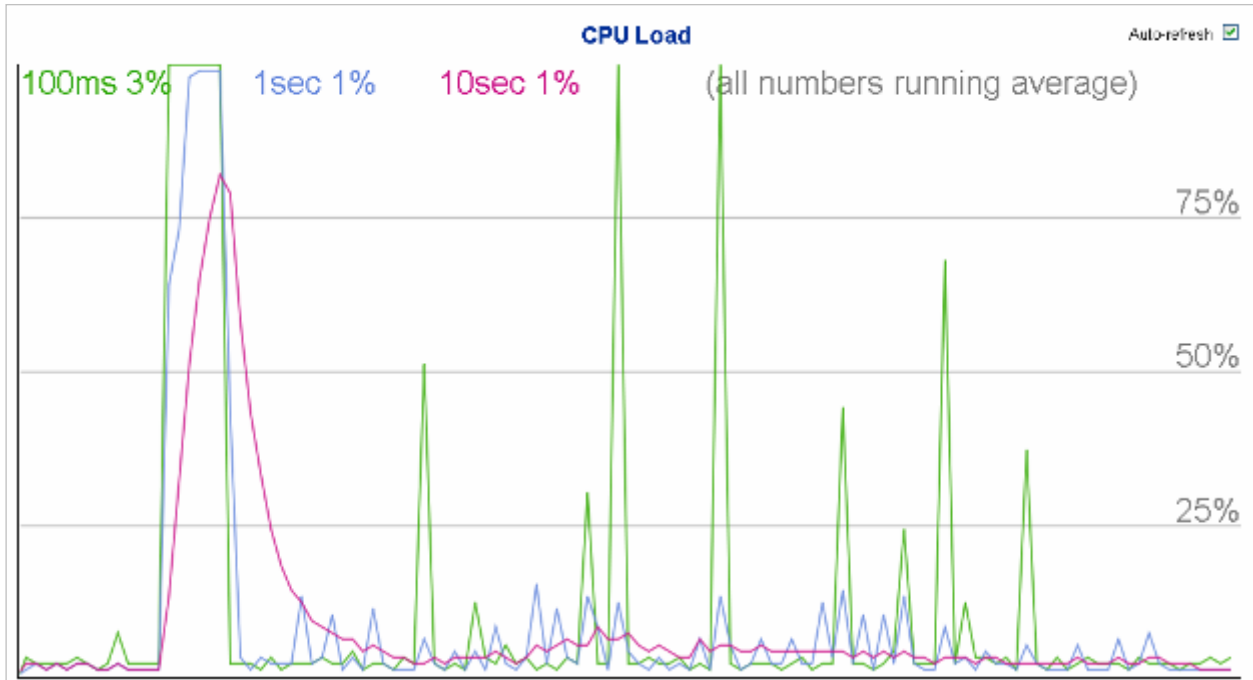

Figure 4-2-14: CPU Load Page Screenshot

#### Buttons

Auto-refresh  : Check this box to refresh the page automatically. Automatic refresh occurs every 3 seconds.



If your browser cannot display anything on this page, please download Adobe SVG tool and install it in your computer.

### 4.2.1.12 System Log

The **Industrial Managed Switch** system log information is provided here. The System Log screen in [Figure 4-2-15](#) appears.

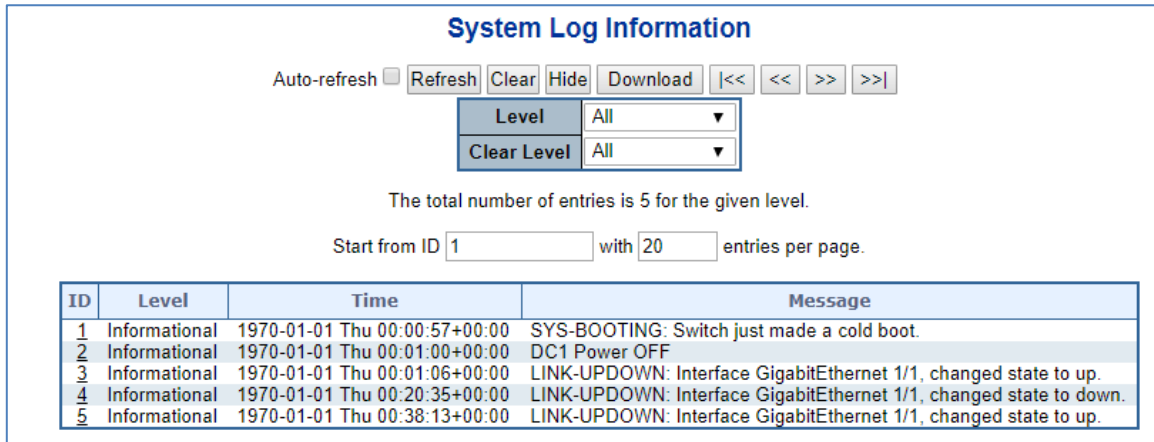

**Figure 4-2-15: System Log Page Screenshot**

The page includes the following fields:

Object	Description
<ul style="list-style-type: none"> <li>• <b>ID</b></li> </ul>	The ID ( $\geq 1$ ) of the system log entry.
<ul style="list-style-type: none"> <li>• <b>Level</b></li> </ul>	The level of the system log entry. The following level types are supported: <ul style="list-style-type: none"> <li>■ <b>Info</b>: Information level of the system log.</li> <li>■ <b>Warning</b>: Warning level of the system log.</li> <li>■ <b>Error</b>: Error level of the system log.</li> <li>■ <b>All</b>: All levels.</li> </ul>
<ul style="list-style-type: none"> <li>• <b>Clear Level</b></li> </ul>	To clear the system log entry level. The following level types are supported: <ul style="list-style-type: none"> <li>■ <b>Info</b>: Information level of the system log.</li> <li>■ <b>Warning</b>: Warning level of the system log.</li> <li>■ <b>Error</b>: Error level of the system log.</li> <li>■ <b>All</b>: All levels.</li> </ul>
<ul style="list-style-type: none"> <li>• <b>Time</b></li> </ul>	The time of the system log entry.
<ul style="list-style-type: none"> <li>• <b>Message</b></li> </ul>	The message of the system log entry.

#### Buttons

Auto-refresh  : Check this box to refresh the page automatically. Automatic refresh occurs every 3 seconds.

**Refresh** : Updates the system log entries, starting from the current entry ID.

**Clear** : Flushes the selected log entries.

**Hide** : Hides the selected log entries.

**Download** : Downloads the selected log entries.

**<<** : Updates the system log entries, starting from the first available entry ID.

: Updates the system log entries, ending at the last entry currently displayed.

: Updates the system log entries, starting from the last entry currently displayed.

: Updates the system log entries, ending at the last available entry ID.

#### 4.2.1.13 Detailed Log

The **Industrial Managed Switch** system detailed log information is provided here. The Detailed Log screen in [Figure 4-2-16](#) appears.

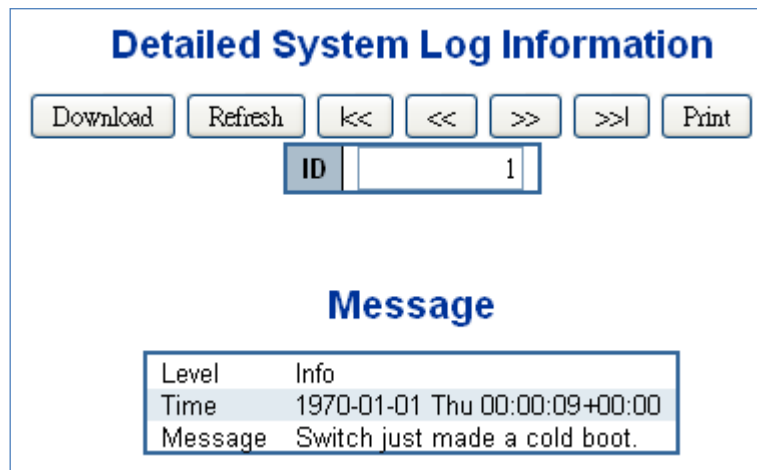

**Figure 4-2-16:** Detailed Log Page Screenshot

The page includes the following fields:

Object	Description
• ID	The ID ( $\geq 1$ ) of the system log entry.
• Message	The message of the system log entry.

#### Buttons

: Download the system log entry to the current entry ID.

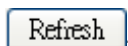
: Updates the system log entry to the current entry ID.

: Updates the system log entry to the first available entry ID.

: Updates the system log entry to the previous available entry ID.

: Updates the system log entry to the next available entry ID.

: Updates the system log entry to the last available entry ID.

: Print the system log entry to the current entry ID.



#### 4.2.1.14 Remote Syslog

Configure remote syslog on this page. The Remote Syslog screen in [Figure 4-2-17](#) appears.

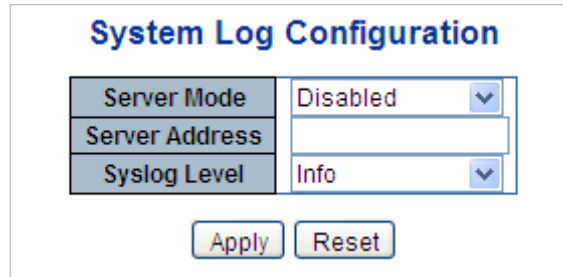



**Figure 4-2-17:** Remote Syslog Page Screenshot

The page includes the following fields:

Object	Description
<ul style="list-style-type: none"> <li>• <b>Mode</b></li> </ul>	<p>Indicates the server mode operation. When the mode operation is enabled, the syslog message will send out to syslog server. The syslog protocol is based on UDP communication and received on <b>UDP port 514</b> and the syslog server will not send acknowledgments back sender since UDP is a connectionless protocol and it does not provide acknowledgments. The syslog packet will always send out even if the syslog server does not exist. Possible modes are:</p> <ul style="list-style-type: none"> <li>■ <b>Enabled:</b> Enable remote syslog mode operation.</li> <li>■ <b>Disabled:</b> Disable remote syslog mode operation.</li> </ul>
<ul style="list-style-type: none"> <li>• <b>Syslog Server IP</b></li> </ul>	<p>Indicates the IPv4 host address of syslog server. If the switch provides DNS feature, it also can be a host name.</p>
<ul style="list-style-type: none"> <li>• <b>Syslog Level</b></li> </ul>	<p>Indicates what kind of message will send to syslog server. Possible modes are:</p> <ul style="list-style-type: none"> <li>■ <b>Info:</b> Send information, warnings and errors.</li> <li>■ <b>Warning:</b> Send warnings and errors.</li> <li>■ <b>Error:</b> Send errors.</li> </ul>

#### Buttons

 : Click to apply changes

 : Click to undo any changes made locally and revert to previously saved values.

#### 4.2.1.15 SMTP Configuration

This page facilitates an SMTP Configuration on the switch.

### SMTP/SNMP Trap Event Alert

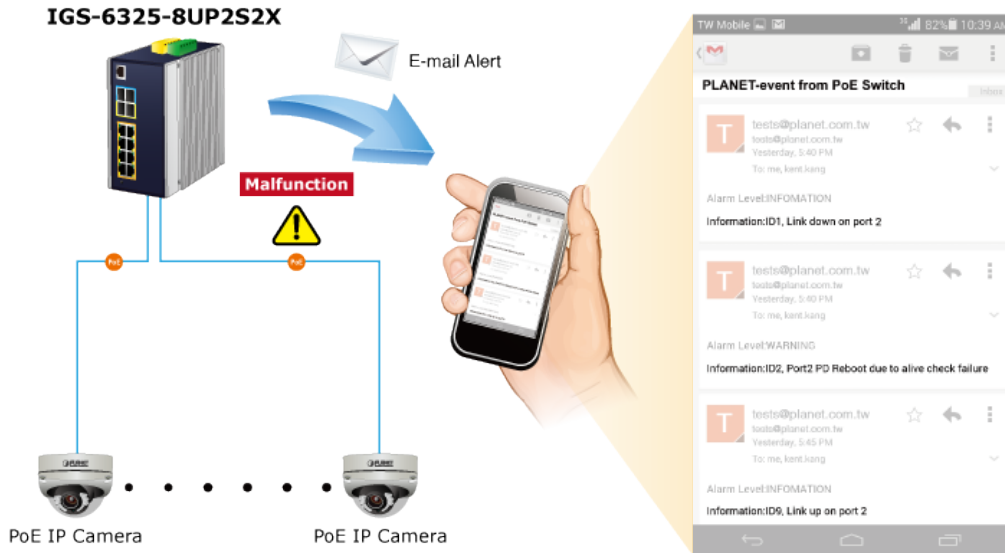

The SMTP Configure screen in [Figure 4-2-18](#) appears.

### SMTP Configuration

<b>SMTP Mode</b>	<input type="checkbox"/> Enable	
<b>SMTP Server</b>	<input type="text" value="planet.com.tw"/> (< 128 Digits)	<input type="button" value="test"/>
<b>SMTP Port</b>	<input type="text" value="25"/> (1 ~ 65535)	
<b>SMTP Authentication</b>	<input type="checkbox"/> Enable	
<b>Authentication User Name</b>	<input type="text" value="1234"/> (< 64 Digits)	
<b>Authentication Password</b>	<input type="password" value="●●●●"/> (< 21 Digits)	
<b>E-mail From</b>	<input type="text" value="abod@planet.com.tw"/> (< 128 Digits)	
<b>E-mail Subject</b>	<input type="text" value="PLANET"/> (< 64 Digits)	
<b>E-mail 1 To</b>	<input type="text" value="abod@planet.com.tw"/> (< 128 Digits)	
<b>E-mail 2 To</b>	<input type="text" value="abod@planet.com.tw"/> (< 128 Digits)	

Figure 4-2-18: SMTP Configuration Page Screenshot

The page includes the following fields:

Object	Description
• <b>SMTP Mode</b>	Controls whether SMTP is enabled on this switch.
• <b>SMTP Server</b>	Type the SMTP server name or the IP address of the SMTP server.
• <b>SMTP Port</b>	Set port number of SMTP service.
• <b>SMTP Authentication</b>	Controls whether SMTP authentication is enabled if authentication is required

	when an e-mail is sent.
• <b>Authentication User Name</b>	Type the user name for the SMTP server if Authentication is Enabled.
• <b>Authentication Password</b>	Type the password for the SMTP server if Authentication is Enabled.
• <b>E-mail From</b>	Type the sender's e-mail address. This address is used for reply e-mails.
• <b>E-mail Subject</b>	Type the subject/title of the e-mail.
• <b>E-mail 1 To</b>	Type the receiver's e-mail address.
• <b>E-mail 2 To</b>	

**Buttons**

: Send a test mail to mail server to check whether this account is available or not.

: Click to save changes.

: Click to undo any changes made locally and revert to previously saved values.

#### 4.2.1.16 Fault Alarm

The Industrial Managed Switch supports a Fault Alarm feature which can alert the users when there is something wrong with the switches. With this ideal feature, the users would not have to waste time finding where the problem is. It will help to save time and human resource.

## Fault Alarm Feature

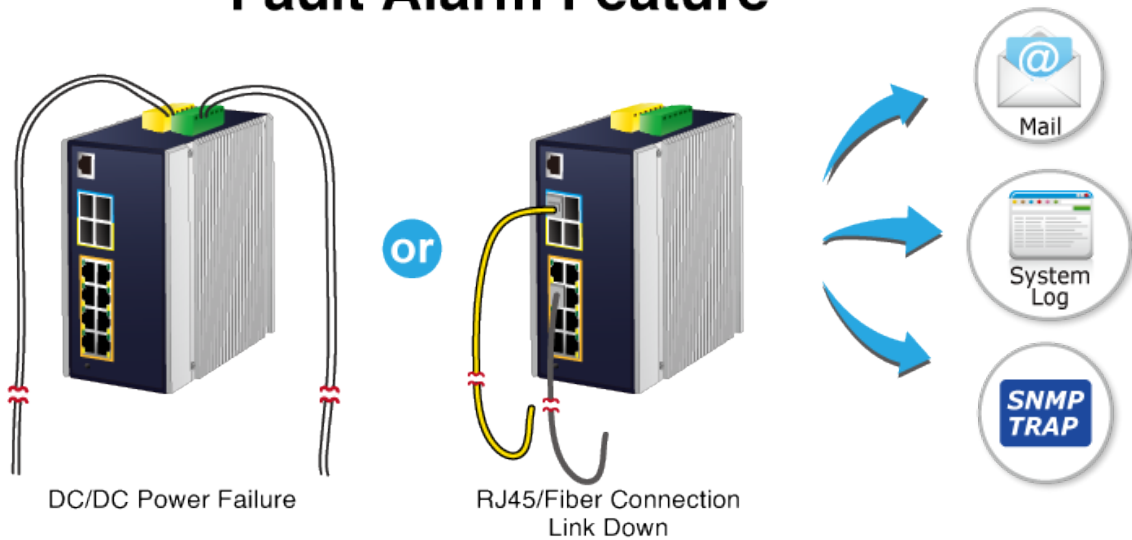

The Fault Alarm screen in [Figure 4-2-19](#) appears.

### Fault Alarm Control Configuration

Fault Alarm Output																																																																	
Enable	<input type="checkbox"/> Enable																																																																
Record	<input type="checkbox"/> System Log <input type="checkbox"/> SNMP Trap																																																																
Action	<input type="checkbox"/> Port Fail <input type="checkbox"/> Power Fail																																																																
Power Alarm	<input type="checkbox"/> DC 1 <input type="checkbox"/> DC 2 <input type="checkbox"/> AC Power																																																																
Port Alarm	<table style="width: 100%; text-align: center;"> <tr> <td>1</td><td>2</td><td>3</td><td>4</td><td>5</td><td>6</td><td>7</td><td>8</td> </tr> <tr> <td><input type="checkbox"/></td><td><input type="checkbox"/></td><td><input type="checkbox"/></td><td><input type="checkbox"/></td><td><input type="checkbox"/></td><td><input type="checkbox"/></td><td><input type="checkbox"/></td><td><input type="checkbox"/></td> </tr> <tr> <td>9</td><td>10</td><td>11</td><td>12</td><td>13</td><td>14</td><td>15</td><td>16</td> </tr> <tr> <td><input type="checkbox"/></td><td><input type="checkbox"/></td><td><input type="checkbox"/></td><td><input type="checkbox"/></td><td><input type="checkbox"/></td><td><input type="checkbox"/></td><td><input type="checkbox"/></td><td><input type="checkbox"/></td> </tr> <tr> <td>17</td><td>18</td><td>19</td><td>20</td><td>21</td><td>22</td><td>23</td><td>24</td> </tr> <tr> <td><input type="checkbox"/></td><td><input type="checkbox"/></td><td><input type="checkbox"/></td><td><input type="checkbox"/></td><td><input type="checkbox"/></td><td><input type="checkbox"/></td><td><input type="checkbox"/></td><td><input type="checkbox"/></td> </tr> <tr> <td>25</td><td>26</td><td>27</td><td>28</td><td></td><td></td><td></td><td></td> </tr> <tr> <td><input type="checkbox"/></td><td><input type="checkbox"/></td><td><input type="checkbox"/></td><td><input type="checkbox"/></td><td></td><td></td><td></td><td></td> </tr> </table>	1	2	3	4	5	6	7	8	<input type="checkbox"/>	<input type="checkbox"/>	<input type="checkbox"/>	<input type="checkbox"/>	<input type="checkbox"/>	<input type="checkbox"/>	<input type="checkbox"/>	<input type="checkbox"/>	9	10	11	12	13	14	15	16	<input type="checkbox"/>	<input type="checkbox"/>	<input type="checkbox"/>	<input type="checkbox"/>	<input type="checkbox"/>	<input type="checkbox"/>	<input type="checkbox"/>	<input type="checkbox"/>	17	18	19	20	21	22	23	24	<input type="checkbox"/>	<input type="checkbox"/>	<input type="checkbox"/>	<input type="checkbox"/>	<input type="checkbox"/>	<input type="checkbox"/>	<input type="checkbox"/>	<input type="checkbox"/>	25	26	27	28					<input type="checkbox"/>	<input type="checkbox"/>	<input type="checkbox"/>	<input type="checkbox"/>				
	1	2	3	4	5	6	7	8																																																									
	<input type="checkbox"/>	<input type="checkbox"/>	<input type="checkbox"/>	<input type="checkbox"/>	<input type="checkbox"/>	<input type="checkbox"/>	<input type="checkbox"/>	<input type="checkbox"/>																																																									
	9	10	11	12	13	14	15	16																																																									
	<input type="checkbox"/>	<input type="checkbox"/>	<input type="checkbox"/>	<input type="checkbox"/>	<input type="checkbox"/>	<input type="checkbox"/>	<input type="checkbox"/>	<input type="checkbox"/>																																																									
17	18	19	20	21	22	23	24																																																										
<input type="checkbox"/>	<input type="checkbox"/>	<input type="checkbox"/>	<input type="checkbox"/>	<input type="checkbox"/>	<input type="checkbox"/>	<input type="checkbox"/>	<input type="checkbox"/>																																																										
25	26	27	28																																																														
<input type="checkbox"/>	<input type="checkbox"/>	<input type="checkbox"/>	<input type="checkbox"/>																																																														
<input type="button" value="Apply"/> <input type="button" value="Reset"/>																																																																	

**Figure 4-2-19:** Fault Alarm Control Configuration page Screenshot

The page includes the following fields:

Object	Description
• <b>Enable</b>	Controls whether Fault Alarm is enabled on this switch.
• <b>Record</b>	Controls whether Record is sending System log or SNMP Trap or both.

• <b>Action</b>	Controls whether Port Fail or Power Fail or both for fault detecting.
• <b>Power Alarm</b>	Controls whether AC, DC1 or DC2 or both for fault detecting.
• <b>Port Alarm</b>	Controls which Ports or all for fault detecting.

**Buttons**

 **Apply** : Click to apply changes

 **Reset** : Click to undo any changes made locally and revert to previously saved values.

#### 4.2.1.17 Digital Input/Output

**Digital Input** allows user to log external device (such as industrial cooler) dead or alive or something else. System will log a user customized message into system log and syslog, and issue SNMP trap or issue an alarm E-mail.

#### Digital Input

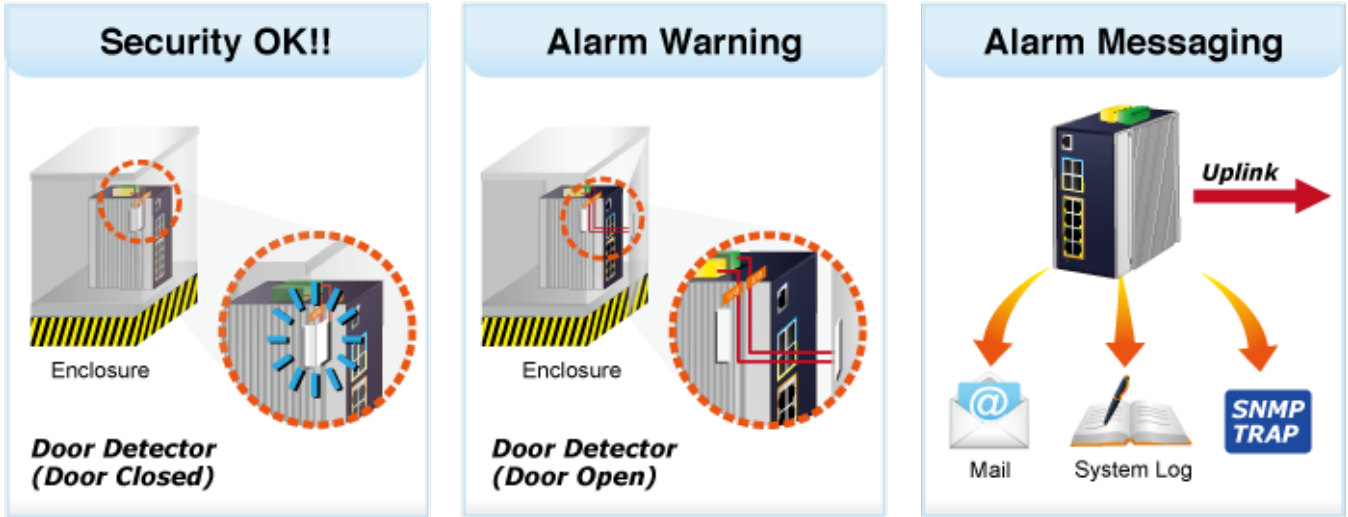

**Digital Output** allows user to monitor the switch port and power, and let system issue a high or low signal to an external device (such as alarm) when the monitor port or power has failed.

#### Digital Output

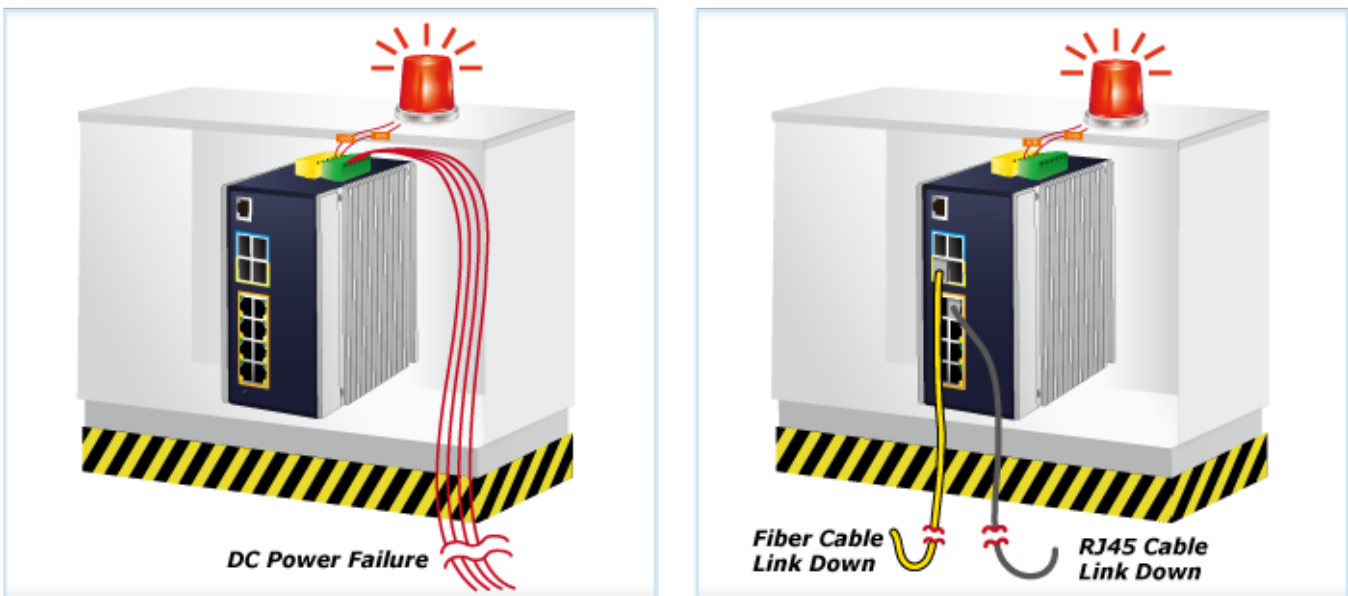

The Configuration screen in [Figure 4-2-20](#) appears.

Digital Input 0		Digital Input 1	
Enable	<input type="checkbox"/> Enable	Enable	<input type="checkbox"/> Enable
DI Condition	High to Low ▾	DI Condition	High to Low ▾
Event Description	Customize DI0 Message.	Event Description	Customize DI1 Message.
Action	<input type="checkbox"/> System Log <input type="checkbox"/> SNMP Trap	Action	<input type="checkbox"/> System Log <input type="checkbox"/> SNMP Trap

Figure 4-2-20 Digital Input Control Configuration page Screenshot

The page includes the following fields:

Object	Description
<ul style="list-style-type: none"> <li><b>Enable</b></li> </ul>	Check the Enable checkbox to enable Digital Input function. Uncheck the Enable checkbox to disable Digital Input function.
<ul style="list-style-type: none"> <li><b>DI Condition</b></li> </ul>	<b>As Digital Input:</b> Allows user to select High to Low or Low to High. This means a signal received by system is from High to Low or From Low to High. It will trigger an action that logs a customize message or issue the message from the switch.
<ul style="list-style-type: none"> <li><b>Event Description</b></li> </ul>	Allows user to set a customized message for Digital Input function alarming.
<ul style="list-style-type: none"> <li><b>Action</b></li> </ul>	<b>As Digital Input:</b> Allows user to record alarm message to <b>System log, syslog</b> or issues out via <b>SNMP Trap</b> or <b>SMTP</b> . As default SNMP Trap and SMTP are disabled, please enable them first if you want to issue alarm message via them.

Digital Output 0		Digital Output 1	
Enable	<input type="checkbox"/> Enable	Enable	<input type="checkbox"/> Enable
Event	<input type="checkbox"/> Power Fail <input type="checkbox"/> Port Fail <input type="checkbox"/> DI 0 <input type="checkbox"/> DI 1	Event	<input type="checkbox"/> Power Fail <input type="checkbox"/> Port Fail <input type="checkbox"/> DI 0 <input type="checkbox"/> DI 1
DI Condition	High to Low ▾	DI Condition	High to Low ▾
Power Alarm	<input type="checkbox"/> PWR 1 <input type="checkbox"/> PWR 2	Power Alarm	<input type="checkbox"/> PWR 1 <input type="checkbox"/> PWR 2
Port Fail Alarm	1 2 3 4 5 6 7 8 <input type="checkbox"/> <input type="checkbox"/> <input type="checkbox"/> <input type="checkbox"/> <input type="checkbox"/> <input type="checkbox"/> <input type="checkbox"/> <input type="checkbox"/>	Port Fail Alarm	1 2 3 4 5 6 7 8 <input type="checkbox"/> <input type="checkbox"/> <input type="checkbox"/> <input type="checkbox"/> <input type="checkbox"/> <input type="checkbox"/> <input type="checkbox"/> <input type="checkbox"/>
	9 10 <input type="checkbox"/> <input type="checkbox"/>		9 10 <input type="checkbox"/> <input type="checkbox"/>
	<input type="checkbox"/> <input type="checkbox"/>		<input type="checkbox"/> <input type="checkbox"/>

Figure 4-2-20 Digital Output Control Configuration page Screenshot

The page includes the following fields:

Object	Description
<ul style="list-style-type: none"> <li><b>Enable</b></li> </ul>	Check the Enable checkbox to enable Digital Output function. Uncheck the Enable checkbox to disable Output function.
<ul style="list-style-type: none"> <li><b>Event</b></li> </ul>	<b>As Digital Output:</b>

	Allows user to monitor an alarm from <b>port failure, power failure, Digital Input 0 (DI 0) and Digital Input 1(DI 1)</b> which means if Digital Output has detected these events, then Digital Output would be triggered according to the setting of Condition.
<ul style="list-style-type: none"> <li>• <b>DI Condition</b></li> </ul>	<p><b>As Digital Output:</b></p> <p>Allows user to select High to Low or Low to High. This means that when the switch is power-failed or port-failed, then system will issue a High or Low signal to an external device such as an alarm.</p>
<ul style="list-style-type: none"> <li>• <b>Power Alarm</b></li> </ul>	Allows user to choose which power module that needs to be monitored.
<ul style="list-style-type: none"> <li>• <b>Port Alarm</b></li> </ul>	Allows user to choose which port that needs to be monitored.

**Buttons**



: Click to save changes.



: Click to undo any changes made locally and revert to previously saved values.



## 4.2.2 Simple Network Management Protocol

### 4.2.2.1 SNMP Overview

The Simple Network Management Protocol (SNMP) is an application layer protocol that facilitates the exchange of management information between network devices. It is part of the Transmission Control Protocol/Internet Protocol (TCP/IP) protocol suite. SNMP enables network administrators to manage network performance, find and solve network problems, and plan for network growth.

An SNMP-managed network consists of three key components: Network management stations (NMSs), SNMP agents, Management information base (MIB) and network-management protocol:

- **Network management stations (NMSs):** Sometimes called consoles, these devices execute management applications that monitor and control network elements. Physically, NMSs are usually engineering workstation-caliber computers with fast CPUs, megapixel color displays, substantial memory, and abundant disk space. At least one NMS must be present in each managed environment.
- **Agents:** Agents are software modules that reside in network elements. They collect and store management information such as the number of error packets received by a network element.
- **Management information base (MIB):** A MIB is a collection of managed objects residing in a virtual information store. Collections of related managed objects are defined in specific MIB modules.
- **Network-management protocol:** A management protocol is used to convey management information between agents and NMSs. SNMP is the Internet community's de facto standard management protocol.

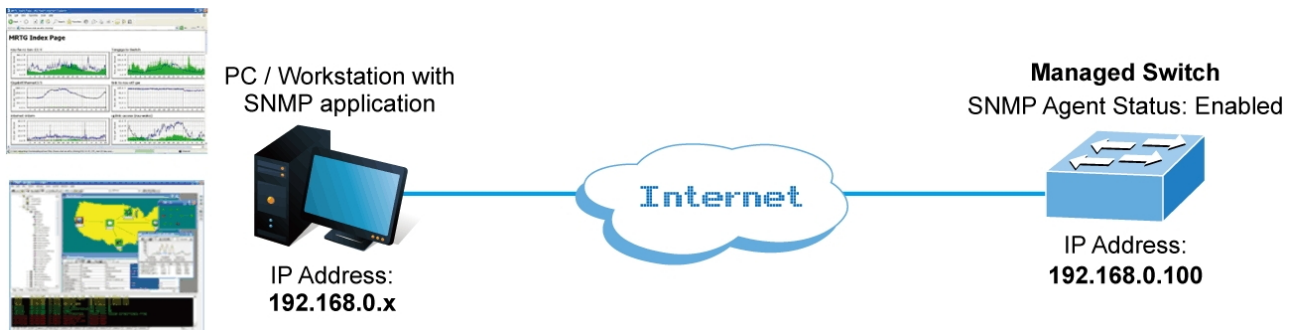

Figure 4-2-2-1:

### SNMP Operations

SNMP itself is a simple request/response protocol. NMSs can send multiple requests without receiving a response.

- **Get** -- Allows the NMS to retrieve an object instance from the agent.
- **Set** -- Allows the NMS to set values for object instances within an agent.
- **Trap** -- Used by the agent to asynchronously inform the NMS of some event. The SNMPv2 trap message is designed to replace the SNMPv1 trap message.

### SNMP community

An SNMP community is the group that devices and management stations running SNMP belong to. It helps define where information is sent. The community name is used to identify the group. An SNMP device or agent may belong to more than one SNMP community. It will not respond to requests from management stations that do not belong to one of its communities. SNMP default communities are:

- **Write** = private
- **Read** = public

Use the SNMP Menu to display or configure the **Industrial Managed Switch** 's SNMP function. This section has the following items:

- **System Configuration**      Configure SNMP on this page.
- **Trap Configuration**      Configure SNMP trap on this page.
- **System Information**      The system information is provided here.
- **SNMPv3 Communities**      Configure SNMPv3 communities table on this page.
- **SNMPv3 Users**      Configure SNMPv3 users table on this page.
- **SNMPv3 Groups**      Configure SNMPv3 groups table on this page.
- **SNMPv3 Views**      Configure SNMPv3 views table on this page.
- **SNMPv3 Access**      Configure SNMPv3 accesses table on this page.

#### 4.2.2.2 SNMP System Configuration

Configure SNMP on this page. The SNMP System Configuration screen in [Figure 4-2-2-2](#) appears.

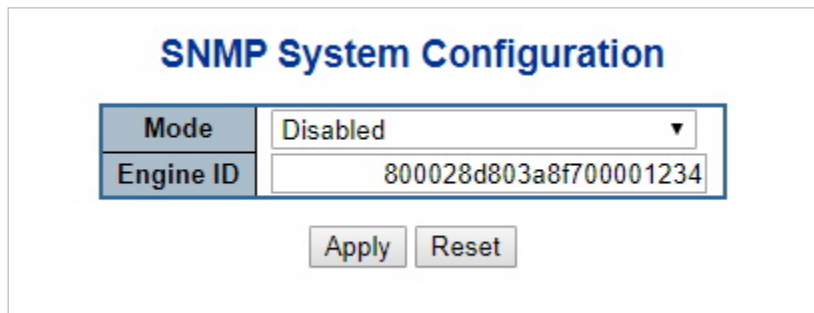



**Figure 4-2-2-2: SNMP System Configuration Page Screenshot**

The page includes the following fields:

Object	Description
<ul style="list-style-type: none"> <li>• <b>Mode</b></li> </ul>	Indicates the SNMP mode operation. Possible modes are: <ul style="list-style-type: none"> <li>■ <b>Enabled</b>: Enable SNMP mode operation.</li> <li>■ <b>Disabled</b>: Disable SNMP mode operation.</li> </ul>
<ul style="list-style-type: none"> <li>• <b>Engine ID</b></li> </ul>	Indicates the SNMPv3 engine ID. The string must contain an even number between 10 and 64 hexadecimal digits, but all-zeros and all-'F's are not allowed. Change of the Engine ID will clear all original local users.

#### Buttons

 : Click to apply changes

 : Click to undo any changes made locally and revert to previously saved values.

### 4.2.2.3 SNMP System Information

The switch system information is provided here. The SNMP System Information screen in [Figure 4-2-2-3](#) appears.



Figure 4-2-2-3: System Information Configuration Page Screenshot

The page includes the following fields:

Object	Description
<ul style="list-style-type: none"> <li>• <b>System Contact</b></li> </ul>	The textual identification of the contact person for this managed node, together with information on how to contact this person. The allowed string length is 0 to 255, and the allowed content is the ASCII characters from 32 to 126.
<ul style="list-style-type: none"> <li>• <b>System Name</b></li> </ul>	An administratively assigned name for this managed node. By convention, this is the node's fully-qualified domain name. A domain name is a text string drawn from the alphabet (A-Za-z), digits (0-9), minus sign (-). No space characters are permitted as part of a name. The first character must be an alpha character. And the first or last character must not be a minus sign. The allowed string length is 0 to 255.
<ul style="list-style-type: none"> <li>• <b>System Location</b></li> </ul>	The physical location of this node(e.g., telephone closet, 3rd floor). The allowed string length is 0 to 255, and the allowed content is the ASCII characters from 32 to 126.

#### 4.2.2.4 SNMP Trap Configuration

Configure SNMP trap on this page. The SNMP Trap Configuration screen in [Figure 4-2-2-4](#) appears.

### Trap Destination Configurations

Delete	Name	Enable	Version	Destination Address	Destination Port
--------	------	--------	---------	---------------------	------------------

Click **'Add New Entry'** and then the SNMP Trap Configuration page appears.

### SNMP Trap Configuration

Trap Config Name	<input type="text"/>
Trap Mode	Disabled ▼
Trap Version	SNMP v2c ▼
Trap Community	public
Trap Destination Address	<input type="text"/>
Trap Destination Port	162
Trap Inform Mode	Disabled ▼
Trap Inform Timeout (seconds)	3
Trap Inform Retry Times	5
Trap Security Engine ID	800028d803a8f700001234
Trap Security Name	None ▼

**Figure 4-2-2-4:** SNMP Trap Configuration Page Screenshot

The page includes the following fields:

Object	Description
• <b>Trap Config</b>	Indicates which trap Configuration's name for configuring. The allowed string length is 0 to 255, and the allowed content is ASCII characters from 33 to 126.
• <b>Trap Mode</b>	Indicates the SNMP trap mode operation. Possible modes are: <ul style="list-style-type: none"> <li>■ <b>Enabled:</b> Enable SNMP trap mode operation.</li> <li>■ <b>Disabled:</b> Disable SNMP trap mode operation.</li> </ul>
• <b>Trap Version</b>	Indicates the SNMP trap supported version. Possible versions are: <ul style="list-style-type: none"> <li>■ <b>SNMP v1:</b> Set SNMP trap supported version 1.</li> <li>■ <b>SNMP v2c:</b> Set SNMP trap supported version 2c.</li> <li>■ <b>SNMP v3:</b> Set SNMP trap supported version 3.</li> </ul>

• <b>Trap Community</b>	Indicates the community access string when send SNMP trap packet. The allowed string length is 0 to 255, and the allowed content is the ASCII characters from 33 to 126.
• <b>Trap Destination Address</b>	Indicates the SNMP trap destination address.
• <b>Trap Destination Port</b>	Indicates the SNMP trap destination port. SNMP Agent will send SNMP message via this port, the port range is 1~65535.
• <b>Trap Inform Mode</b>	Indicates the SNMP trap inform mode operation. Possible modes are: <ul style="list-style-type: none"> <li>■ <b>Enabled</b>: Enable SNMP trap authentication failure.</li> <li>■ <b>Disabled</b>: Disable SNMP trap authentication failure.</li> </ul>
• <b>Trap Inform Timeout (seconds)</b>	Indicates the SNMP trap inform timeout. The allowed range is <b>0</b> to <b>2147</b> .
• <b>Trap Inform Retry Times</b>	Indicates the SNMP trap inform retry times. The allowed range is <b>0</b> to <b>255</b> .
• <b>Trap Probe Security Engine ID</b>	Indicates the SNMPv3 trap probe security engine ID mode of operation. Possible values are: <ul style="list-style-type: none"> <li>■ <b>Enabled</b>: Enable SNMP trap probe security engine ID mode of operation.</li> <li>■ <b>Disabled</b>: Disable SNMP trap probe security engine ID mode of operation.</li> </ul>
• <b>Trap Security Engine ID</b>	Indicates the SNMP trap security engine ID. SNMPv3 sends traps and informs using USM for authentication and privacy. A unique engine ID for these traps and informs is needed. When "Trap Probe Security Engine ID" is enabled, the ID will be probed automatically. Otherwise, the ID specified in this field is used. The string must contain an even number(in hexadecimal format) with number of digits between 10 and 64, but all-zeros and all-'F's are not allowed.
• <b>Trap Security Name</b>	Indicates the SNMP trap security name. SNMPv3 traps and informs using USM for authentication and privacy. A unique security name is needed when traps and informs are enabled.
• <b>System</b>	Enable/disable that the Interface group's traps. Possible traps are: <ul style="list-style-type: none"> <li>■ <b>Warm Start</b>: Enable/disable Warm Start trap.</li> <li>■ <b>Cold Start</b>: Enable/disable Cold Start trap.</li> </ul>
• <b>Interface</b>	Indicates that the Interface group's traps. Possible traps are: <ul style="list-style-type: none"> <li>■ <b>Link Up</b>: Enable/disable Link up trap.</li> <li>■ <b>Link Down</b>: Enable/disable Link down trap.</li> <li>■ <b>LLDP</b>: Enable/disable LLDP trap.</li> </ul>
• <b>AAA</b>	Indicates that the AAA group's traps. Possible traps are: <ul style="list-style-type: none"> <li>■ <b>Authentication Fail</b>: Enable/disable SNMP trap authentication failure trap.</li> </ul>
• <b>Switch</b>	Indicates that the Switch group's traps. Possible traps are: <ul style="list-style-type: none"> <li>■ <b>STP</b>: Enable/disable STP trap.</li> <li>■ <b>RMON</b>: Enable/disable RMON trap.</li> </ul>

#### 4.2.2.5 SNMP Trap Source Configuration

This page provides SNMP trap source configurations. A trap is sent for the given trap source if at least one filter with filter type included matches the filter, and no filters with filter type excluded matches.

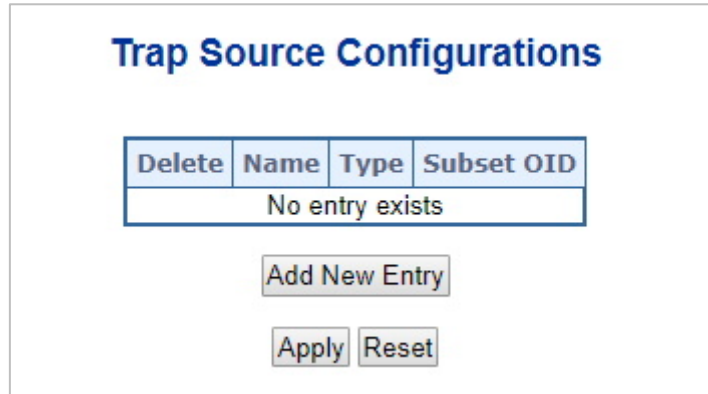

Figure 4-2-2-5: SNMP Trap Source Configuration Page Screenshot

Click **"Add New Entry"** to add a new entry. The maximum entry count is 32.

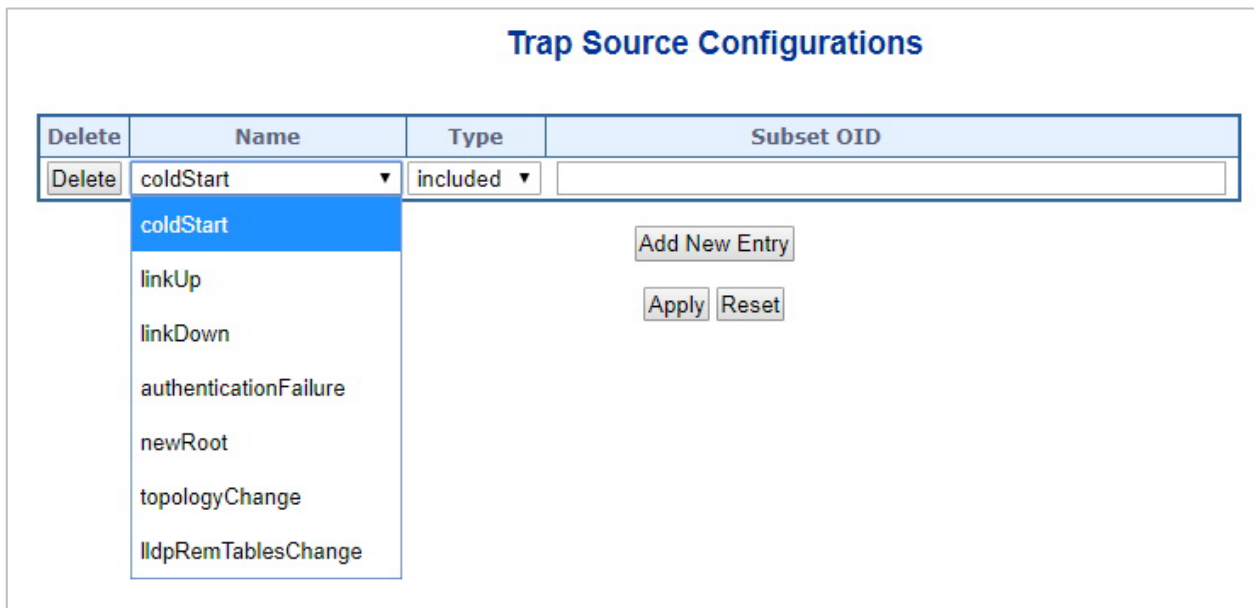

Figure 4-2-2-6: SNMP Trap Source Configuration Page Screenshot

The page includes the following fields:

Object	Description
<ul style="list-style-type: none"> <li><b>Name</b></li> </ul>	Indicates the name for the entry.
<ul style="list-style-type: none"> <li><b>Type</b></li> </ul>	The filter type for the entry. Possible types are: <ul style="list-style-type: none"> <li> <span style="display: inline-block; width: 10px; height: 10px; background-color: black; margin-right: 5px;"></span> <b>included:</b> An optional flag to indicate a trap is sent for the given trap source is matched.                 </li> <li> <span style="display: inline-block; width: 10px; height: 10px; background-color: black; margin-right: 5px;"></span> <b>excluded:</b> An optional flag to indicate a trap is not sent for the given trap                 </li> </ul>

	source is matched.
<ul style="list-style-type: none"><li>• <b>Subset OID</b></li></ul>	<p>The subset OID for the entry.</p> <p>The value should depend on the what kind of trap name.</p> <p>For example, the ifldex is the subset OID of linkUp and linkDown. A valid subset OID is one or more digital number(0-4294967295) or asterisk(*) which are separated by dots(.). The first character must not begin with asterisk(*) and the maximum of OID count must not exceed 128.</p>

**Buttons**

**Add New Entry**

: Click to add a new community entry. The maximum entry count is 32

**Apply**

: Click to apply changes

**Reset**

: Click to undo any changes made locally and revert to previously saved values.

### 4.2.2.6 SNMPv3 Communities

Configure SNMPv3 communities table on this page. The entry index key is Community. The SNMPv3 Communities screen in [Figure 4-2-2-7](#) appears.



Figure 4-2-2-7: SNMPv3 Communities Configuration Page Screenshot

The page includes the following fields:

Object	Description
<ul style="list-style-type: none"> <li>• <b>Delete</b></li> </ul>	Check to delete the entry. It will be deleted during the next save.
<ul style="list-style-type: none"> <li>• <b>Community Name</b></li> </ul>	<p>Indicates the community access string to permit access to SNMPv3 agent.</p> <p>The allowed string length is 1 to 32, and the allowed content is ASCII characters from 33 to 126.</p> <p>The community string will be treated as security name and map a SNMPv1 or SNMPv2c community string.</p>
<ul style="list-style-type: none"> <li>• <b>Community Secret</b></li> </ul>	<p>Indicates the community secret (access string) to permit access using SNMPv1 and SNMPv2c to the SNMP agent.</p> <p>The allowed string length is 1 to 32, and the allowed content is ASCII characters from 33 to 126.</p>
<ul style="list-style-type: none"> <li>• <b>Source IP</b></li> </ul>	<p>Indicates the SNMP access source address.</p> <p>A particular range of source addresses can be used to restrict source subnet when combined with source mask.</p>
<ul style="list-style-type: none"> <li>• <b>Source Mask</b></li> </ul>	Indicates the SNMP access source address mask.

#### Buttons

- : Click to add a new community entry.
- : Click to apply changes
- : Click to undo any changes made locally and revert to previously saved values.



#### 4.2.2.7 SNMPv3 Users

Configure SNMPv3 users table on this page. The entry index keys are Engine ID and User Name. The SNMPv3 Users screen in Figure 4-2-2-8 appears.

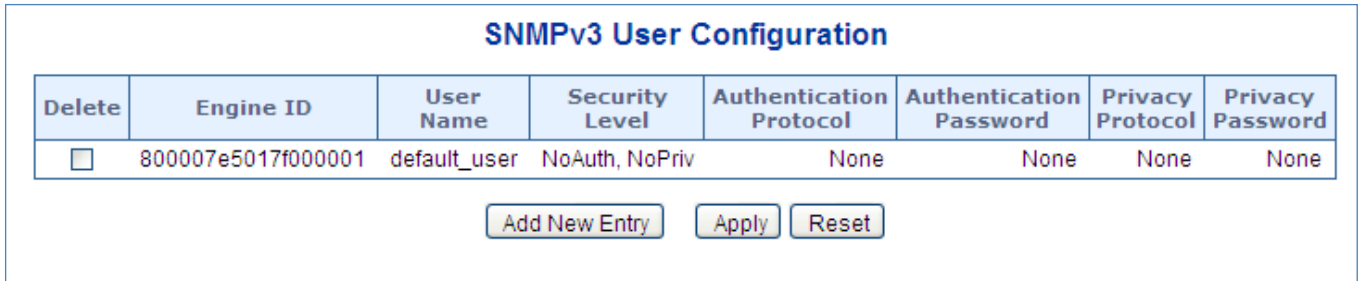



Figure 4-2-2-8: SNMPv3 Users Configuration Page Screenshot

The page includes the following fields:

Object	Description
<ul style="list-style-type: none"> <li>• <b>Delete</b></li> </ul>	Check to delete the entry. It will be deleted during the next save.
<ul style="list-style-type: none"> <li>• <b>Engine ID</b></li> </ul>	<p>An octet string identifying the engine ID that this entry should belong to.</p> <p>The string must contain an even number(in hexadecimal format) with number of digits between 10 and 64, but all-zeros and all-'F's are not allowed.</p> <p>The SNMPv3 architecture uses the <b>User-based Security Model (USM)</b> for message security and the <b>View-based Access Control Model (VACM)</b> for access control. For the USM entry, the usmUserEngineID and usmUserName are the entry's keys.</p> <p>In a simple agent, usmUserEngineID is always that agent's own snmpEngineID value. The value can also take the value of the snmpEngineID of a remote SNMP engine with which this user can communicate. In other words, if user engine ID equal system engine ID then it is local user; otherwise it's remote user.</p>
<ul style="list-style-type: none"> <li>• <b>User Name</b></li> </ul>	<p>A string identifying the user name that this entry should belong to.</p> <p>The allowed string length is 1 to 32, and the allowed content is ASCII characters from 33 to 126.</p>
<ul style="list-style-type: none"> <li>• <b>Security Level</b></li> </ul>	<p>Indicates the security model that this entry should belong to. Possible security models are:</p> <ul style="list-style-type: none"> <li>■ <b>NoAuth, NoPriv</b>: None authentication and none privacy.</li> <li>■ <b>Auth, NoPriv</b>: Authentication and none privacy.</li> <li>■ <b>Auth, Priv</b>: Authentication and privacy.</li> </ul> <p>The value of security level cannot be modified if entry already exist. That means must first ensure that the value is set correctly.</p>
<ul style="list-style-type: none"> <li>• <b>Authentication</b></li> </ul>	Indicates the authentication protocol that this entry should belong to. Possible

<p><b>Protocol</b></p>	<p>authentication protocol are:</p> <ul style="list-style-type: none"> <li>■ <b>None</b>: None authentication protocol.</li> <li>■ <b>MD5</b>: An optional flag to indicate that this user using MD5 authentication protocol.</li> <li>■ <b>SHA</b>: An optional flag to indicate that this user using SHA authentication protocol.</li> </ul> <p>The value of security level cannot be modified if entry already exist. That means must first ensure that the value is set correctly.</p>
<ul style="list-style-type: none"> <li>• <b>Authentication Password</b></li> </ul>	<p>A string identifying the authentication pass phrase.</p> <p>For <b>MD5</b> authentication protocol, the allowed string length is 8 to 32.</p> <p>For <b>SHA</b> authentication protocol, the allowed string length is 8 to 40.</p> <p>The allowed content is the ASCII characters from 33 to 126.</p>
<ul style="list-style-type: none"> <li>• <b>Privacy Protocol</b></li> </ul>	<p>Indicates the privacy protocol that this entry should belong to. Possible privacy protocol are:</p> <ul style="list-style-type: none"> <li>■ <b>None</b>: None privacy protocol.</li> <li>■ <b>DES</b>: An optional flag to indicate that this user using DES authentication protocol.</li> <li>■ <b>AES</b>: An optional flag to indicate that this user uses AES authentication protocol.</li> </ul>
<ul style="list-style-type: none"> <li>• <b>Privacy Password</b></li> </ul>	<p>A string identifying the privacy pass phrase.</p> <p>The allowed string length is 8 to 32, and the allowed content is the ASCII characters from 33 to 126.</p>

**Buttons**

: Click to add a new user entry.

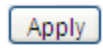
: Click to apply changes

: Click to undo any changes made locally and revert to previously saved values.

### 4.2.2.8 SNMPv3 Groups

Configure SNMPv3 groups table on this page. The entry index keys are Security Model and Security Name. The SNMPv3 Groups screen in [Figure 4-2-2-9](#) appears.

SNMPv3 Group Configuration			
Delete	Security Model	Security Name	Group Name
<input type="checkbox"/>	v1	public	default_ro_group
<input type="checkbox"/>	v1	private	default_rw_group
<input type="checkbox"/>	v2c	public	default_ro_group
<input type="checkbox"/>	v2c	private	default_rw_group

**Figure 4-2-2-9:** SNMPv3 Groups Configuration Page Screenshot

The page includes the following fields:

Object	Description
<ul style="list-style-type: none"> <li>• <b>Delete</b></li> </ul>	Check to delete the entry. It will be deleted during the next save.
<ul style="list-style-type: none"> <li>• <b>Security Model</b></li> </ul>	Indicates the security model that this entry should belong to. Possible security models are: <ul style="list-style-type: none"> <li>■ <b>v1</b>: Reserved for SNMPv1.</li> <li>■ <b>v2c</b>: Reserved for SNMPv2c.</li> <li>■ <b>usm</b>: User-based Security Model (USM).</li> </ul>
<ul style="list-style-type: none"> <li>• <b>Security Name</b></li> </ul>	A string identifying the security name that this entry should belong to. The allowed string length is 1 to 32, and the allowed content is the ASCII characters from 33 to 126.
<ul style="list-style-type: none"> <li>• <b>Group Name</b></li> </ul>	A string identifying the group name that this entry should belong to. The allowed string length is 1 to 32, and the allowed content is the ASCII characters from 33 to 126.

#### Buttons

- : Click to add a new group entry.
- : Click to apply changes
- : Click to undo any changes made locally and revert to previously saved values.

### 4.2.2.9 SNMPv3 Views

Configure SNMPv3 views table on this page. The entry index keys are View Name and OID Subtree. The SNMPv3 Views screen in [Figure 4-2-2-10](#) appears.



Figure 4-2-2-10: SNMPv3 Views Configuration Page Screenshot

The page includes the following fields:

Object	Description
<ul style="list-style-type: none"> <li>• <b>Delete</b></li> </ul>	Check to delete the entry. It will be deleted during the next save.
<ul style="list-style-type: none"> <li>• <b>View Name</b></li> </ul>	A string identifying the view name that this entry should belong to. The allowed string length is 1 to 32, and the allowed content is the ASCII characters from 33 to 126.
<ul style="list-style-type: none"> <li>• <b>View Type</b></li> </ul>	<p>Indicates the view type that this entry should belong to. Possible view type are:</p> <ul style="list-style-type: none"> <li>■ <b>included</b>: An optional flag to indicate that this view subtree should be included.</li> <li>■ <b>excluded</b>: An optional flag to indicate that this view subtree should be excluded.</li> </ul> <p>In general, if a view entry's view type is 'excluded', it should be exist another view entry which view type is 'included' and it's OID subtree overstep the 'excluded' view entry.</p>
<ul style="list-style-type: none"> <li>• <b>OID Subtree</b></li> </ul>	The OID defining the root of the subtree to add to the named view. The allowed OID length is 1 to 128. The allowed string content is digital number or asterisk(*)

#### Buttons

**Add New Entry**: Click to add a new view entry.

**Apply**: Click to apply changes

**Reset**: Click to undo any changes made locally and revert to previously saved values.

#### 4.2.2.10 SNMPv3 Access

Configure SNMPv3 accesses table on this page. The entry index keys are Group Name, Security Model and Security Level. The SNMPv3 Access screen in [Figure 4-2-2-11](#) appears.

### SNMPv3 Access Configuration

Delete	Group Name	Security Model	Security Level	Read View Name	Write View Name
<input type="checkbox"/>	default_ro_group	any	NoAuth, NoPriv	default_view ▼	None ▼
<input type="checkbox"/>	default_rw_group	any	NoAuth, NoPriv	default_view ▼	default_view ▼

Figure 4-2-2-11: SNMPv3 Accesses Configuration Page Screenshot

The page includes the following fields:

Object	Description
• <b>Delete</b>	Check to delete the entry. It will be deleted during the next save.
• <b>Group Name</b>	A string identifying the group name that this entry should belong to. The allowed string length is 1 to 32, and the allowed content is the ASCII characters from 33 to 126.
• <b>Security Model</b>	Indicates the security model that this entry should belong to. Possible security models are: <ul style="list-style-type: none"> <li>■ <b>any</b>: Accepted any security model (v1 v2c usm).</li> <li>■ <b>v1</b>: Reserved for SNMPv1.</li> <li>■ <b>v2c</b>: Reserved for SNMPv2c.</li> <li>■ <b>usm</b>: User-based Security Model (USM)</li> </ul>
• <b>Security Level</b>	Indicates the security model that this entry should belong to. Possible security models are: <ul style="list-style-type: none"> <li>■ <b>NoAuth, NoPriv</b>: None authentication and none privacy.</li> <li>■ <b>Auth, NoPriv</b>: Authentication and none privacy.</li> <li>■ <b>Auth, Priv</b>: Authentication and privacy.</li> </ul>
• <b>Read View Name</b>	The name of the MIB view defining the MIB objects for which this request may request the current values. The allowed string length is 1 to 32, and the allowed content is the ASCII characters from 33 to 126.
• <b>Write View Name</b>	The name of the MIB view defining the MIB objects for which this request may potentially SET new values. The allowed string length is 1 to 32, and the allowed content is the ASCII characters from 33 to 126.

## Buttons

: Click to add a new access entry.

: Click to apply changes

: Click to undo any changes made locally and revert to previously saved values.

### 4.2.3 RMON

RMON is the most important expansion of the standard SNMP. RMON is a set of MIB definitions, used to define standard network monitor functions and interfaces, enabling the communication between SNMP management terminals and remote monitors. RMON provides a highly efficient method to monitor actions inside the subnets.

MID of RMON consists of 10 groups. The switch supports the most frequently used groups 1, 2, 3 and 9:

- **Statistics:** Maintain basic usage and error statistics for each subnet monitored by the agent.
- **History:** Record periodical statistic samples available from statistics.
- **Alarm:** Allow management console users to set any count or integer for sample intervals and alert thresholds for RMON agent records.
- **Event:** A list of all events generated by RMON agent.

Alarm depends on the implementation of Event. Statistics and History display some current or history subnet statistics. Alarm and Event provide a method to monitor any integer data change in the network, and provide some alerts upon abnormal events (sending Trap or record in logs).

#### 4.2.3.1 RMON Alarm Configuration

Configure RMON Alarm table on this page. The entry index key is **ID**.; screen in [Figure 4-2-3-1](#) appears.



Figure 4-2-3-1: RMON Alarm Configuration Page Screenshot

The page includes the following fields:

Object	Description
• <b>Delete</b>	Check to delete the entry. It will be deleted during the next save.
• <b>ID</b>	Indicates the index of the entry. The range is from 1 to 65535.
• <b>Interval</b>	Indicates the interval in seconds for sampling and comparing the rising and falling threshold. The range is from 1 to 2 <sup>31</sup> -1.
• <b>Variable</b>	Indicates the particular variable to be sampled; the possible variables are: <ul style="list-style-type: none"> <li>■ <b>InOctets:</b> The total number of octets received on the interface, including framing characters.</li> <li>■ <b>InUcastPkts:</b> The number of uni-cast packets delivered to a higher-layer protocol.</li> </ul>

	<ul style="list-style-type: none"> <li>■ <b>InNUcastPkts</b>: The number of broadcast and multi-cast packets delivered to a higher-layer protocol.</li> <li>■ <b>InDiscards</b>: The number of inbound packets that are discarded even the packets are normal.</li> <li>■ <b>InErrors</b>: The number of inbound packets that contains errors preventing them from being deliverable to a higher-layer protocol.</li> <li>■ <b>InUnknownProtos</b>: the number of the inbound packets that is discarded because of the unknown or un-support protocol.</li> <li>■ <b>OutOctets</b>: The number of octets transmitted out of the interface, including framing characters.</li> <li>■ <b>OutUcastPkts</b>: The number of uni-cast packets that requests to transmit.</li> <li>■ <b>OutNUcastPkts</b>: The number of broadcast and multi-cast packets that requests to transmit.</li> <li>■ <b>OutDiscards</b>: The number of outbound packets that is discarded even the packets are normal.</li> <li>■ <b>OutErrors</b>: The number of outbound packets that could not be transmitted because of errors.</li> <li>■ <b>OutQLen</b>: The length of the output packet queue (in packets).</li> </ul>
• <b>Sample Type</b>	<p>The method of sampling the selected variable and calculating the value to be compared against the thresholds; possible sample types are:</p> <ul style="list-style-type: none"> <li>■ <b>Absolute</b>: Get the sample directly.</li> <li>■ <b>Delta</b>: Calculate the difference between samples (default).</li> </ul>
• <b>Value</b>	<p>The value of the statistic during the last sampling period.</p>
• <b>Startup Alarm</b>	<p>The method of sampling the selected variable and calculating the value to be compared against the thresholds; possible sample types are:</p> <ul style="list-style-type: none"> <li>■ <b>Rising</b> Trigger alarm when the first value is larger than the rising threshold.</li> <li>■ <b>Falling</b> Trigger alarm when the first value is less than the falling threshold.</li> <li>■ <b>RisingOrFalling</b> Trigger alarm when the first value is larger than the rising threshold or less than the falling threshold (default).</li> </ul>
• <b>Rising Threshold</b>	<p>Rising threshold value (-2147483648-2147483647).</p>
• <b>Rising Index</b>	<p>Rising event index (1-65535).</p>
• <b>Falling Threshold</b>	<p>Falling threshold value (-2147483648-2147483647)</p>
• <b>Falling Index</b>	<p>Falling event index (1-65535).</p>

**Buttons**

: Click to add a new community entry.

: Click to apply changes

: Click to undo any changes made locally and revert to previously saved values.



### 4.2.3.2 RMON Alarm Status

This page provides an overview of RMON Alarm entries. Each page shows up to 99 entries from the Alarm table, default being 20, selected through the "entries per page" input field. When first visited, the web page will show the first 20 entries from the beginning of the Alarm table. The first displayed will be the one with the lowest ID found in the Alarm table; screen in [Figure 4-2-3-2](#) appears.



Figure 4-2-3-2: RMON Alarm Overview Page Screenshot

The page includes the following fields:

Object	Description
• ID	Indicates the index of Alarm control entry.
• Interval	Indicates the interval in seconds for sampling and comparing the rising and falling threshold.
• Variable	Indicates the particular variable to be sampled.
• Sample Type	The method of sampling the selected variable and calculating the value to be compared against the thresholds.
• Value	The value of the statistic during the last sampling period.
• Startup Alarm	The alarm that may be sent when this entry is first set to valid.
• Rising Threshold	Rising threshold value
• Rising Index	Rising event index
• Falling Threshold	Falling threshold value
• Falling Index	Falling event index

#### Buttons

: Click to refresh the page immediately.

Auto-refresh : Check this box to refresh the page automatically. Automatic refresh occurs every 3 seconds.

: Updates the table, starting from the first entry in the Alarm Table, i.e. the entry with the lowest ID.

: Updates the table, starting with the entry after the last entry currently displayed.

### 4.2.3.3 RMON Event Configuration

Configure RMON Event table on this page. The entry index key is **ID**; screen in [Figure 4-2-3-3](#) appears.

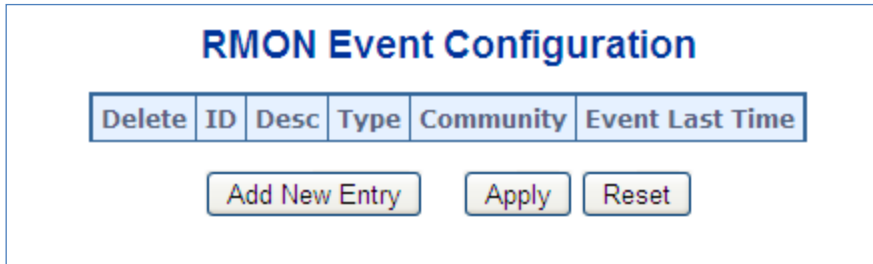





Figure 4-2-3-3 RMON Event Configuration Page Screenshot

The page includes the following fields:

Object	Description
• <b>Delete</b>	Check to delete the entry. It will be deleted during the next save.
• <b>ID</b>	Indicates the index of the entry. The range is from 1 to 65535.
• <b>Desc</b>	Indicates this event, the string length is from 0 to 127, default is a null string.
• <b>Type</b>	Indicates the notification of the event; the possible types are: <ul style="list-style-type: none"> <li>■ <b>none</b>: The total number of octets received on the interface, including framing characters.</li> <li>■ <b>log</b>: The number of uni-cast packets delivered to a higher-layer protocol.</li> <li>■ <b>snmptrap</b>: The number of broad-cast and multi-cast packets delivered to a higher-layer protocol.</li> <li>■ <b>logandtrap</b>: The number of inbound packets that are discarded even the packets are normal.</li> </ul>
• <b>Community</b>	Specify the community when trap is sent, the string length is from 0 to 127, default is "public".
• <b>Event Last Time</b>	Indicates the value of sysUpTime at the time this event entry last generated an event.

#### Buttons

- : Click to add a new community entry.
- : Click to apply changes
- : Click to undo any changes made locally and revert to previously saved values.

### 4.2.3.4 RMON Event Status

This page provides an overview of RMON Event table entries. Each page shows up to 99 entries from the Event table, default being 20, selected through the "entries per page" input field. When first visited, the web page will show the first 20 entries from the beginning of the Event table. The first displayed will be the one with the lowest Event Index and Log Index found in the Event table; screen in [Figure 4-2-3-4](#) appears.

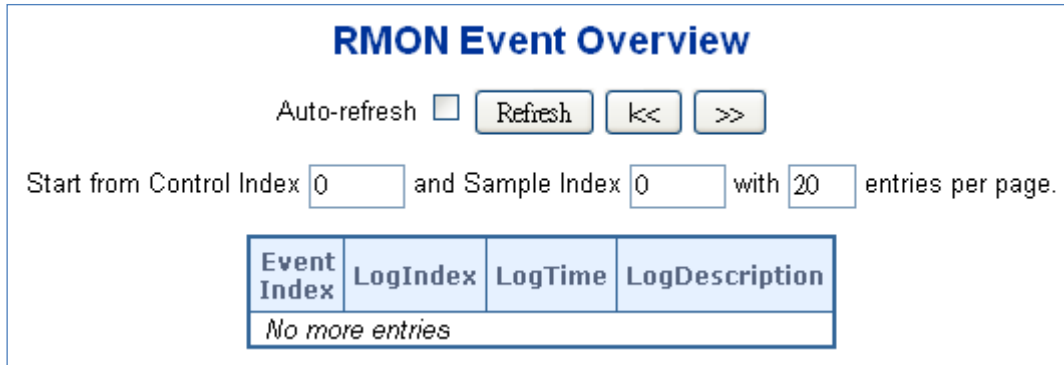

**Figure 4-2-3-4:** RMON Event Overview Page Screenshot

The page includes the following fields:

Object	Description
• <b>Event Index</b>	Indicates the index of the event entry.
• <b>Log Index</b>	Indicates the index of the log entry.
• <b>Logtime</b>	Indicates Event log time.
• <b>Log Description</b>	Indicates the Event description.

#### Buttons

: Click to refresh the page immediately.

Auto-refresh : Check this box to refresh the page automatically. Automatic refresh occurs every 3 seconds.

: Updates the table starting from the first entry in the Alarm Table, i.e. the entry with the lowest ID.

: Updates the table, starting with the entry after the last entry currently displayed.

: Updates the table, starting with the entry after the last entry currently displayed.

### 4.2.3.5 RMON History Configuration

Configure RMON History table on this page. The entry index key is **ID**; screen in [Figure 4-2-3-5](#) appears.

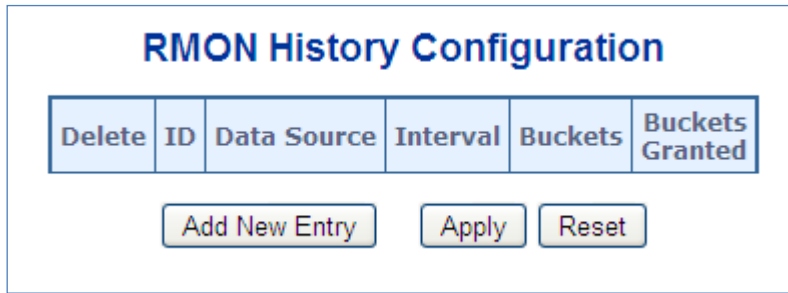

**Figure 4-2-3-5:** RMON History Configuration Page Screenshot

The page includes the following fields:

Object	Description
• <b>Delete</b>	Check to delete the entry. It will be deleted during the next save.
• <b>ID</b>	Indicates the index of the entry. The range is from 1 to 65535.
• <b>Data Source</b>	Indicates the port ID which wants to be monitored.
• <b>Interval</b>	Indicates the interval in seconds for sampling the history statistics data. The range is from 1 to 3600, default value is 1800 seconds.
• <b>Buckets</b>	Indicates the maximum data entries associated this History control entry stored in RMON. The range is from 1 to 3600, default value is 50.
• <b>Buckets Granted</b>	The number of data will be saved in the RMON.

#### Buttons

**Add New Entry**: Click to add a new community entry.

**Apply**: Click to apply changes

**Reset**: Click to undo any changes made locally and revert to previously saved values.

### 4.2.3.6 RMON History Status

This page provides an detail of RMON history entries; screen in [Figure 4-2-3-6](#) appears.

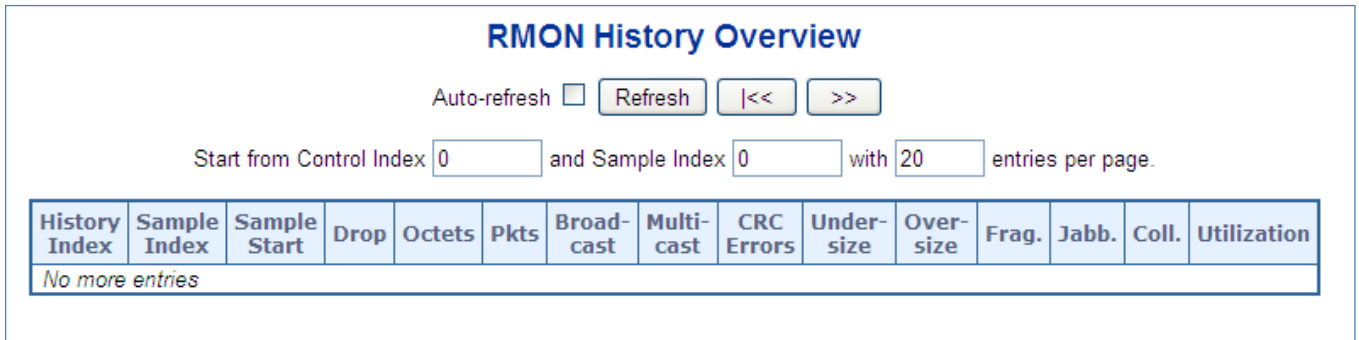

Figure 4-2-3-6: RMON History Overview Page Screenshot

The page includes the following fields:

Object	Description
• <b>History Index</b>	Indicates the index of History control entry.
• <b>Sample Index</b>	Indicates the index of the data entry associated with the control entry.
• <b>Sample Start</b>	The value of sysUpTime at the start of the interval over which this sample was measured.
• <b>Drop</b>	The total number of events in which packets were dropped by the probe due to lack of resources.
• <b>Octets</b>	The total number of octets of data (including those in bad packets) received on the network.
• <b>Pkts</b>	The total number of packets (including bad packets, broadcast packets, and multicast packets) received.
• <b>Broadcast</b>	The total number of good packets received that were directed to the broadcast address.
• <b>Multicast</b>	The total number of good packets received that were directed to a multicast address.
<b>CRC Errors</b>	The total number of packets received that had a length (excluding framing bits, but including FCS octets) of between 64 and 1518 octets, inclusive, but had either a bad Frame Check Sequence (FCS) with an integral number of octets (FCS Error) or a bad FCS with a non-integral number of octets (Alignment Error).
• <b>Undersize</b>	The total number of packets received that were less than 64 octets.
• <b>Oversize</b>	The total number of packets received that were longer than 1518 octets.
• <b>Frag.</b>	The number of frames whose size is less than 64 octets received with invalid CRC.
• <b>Jabb.</b>	The number of frames whose size is larger than 64 octets received with invalid CRC.
• <b>Coll.</b>	The best estimate of the total number of collisions in this Ethernet segment.

<ul style="list-style-type: none"> <li>• <b>Utilization</b></li> </ul>	The best estimate of the mean physical layer network utilization on this interface during this sampling interval, in hundredths of a percent.
--	---

**Buttons**

: Click to refresh the page immediately.

Auto-refresh : Check this box to refresh the page automatically. Automatic refresh occurs every 3 seconds.

: Updates the table, starting from the first entry in the History table, i.e., the entry with the lowest History

Index and Sample Index

: Updates the table, starting with the entry after the last entry currently displayed.

**4.2.3.7 RMON Statistics Configuration**

Configure RMON Statistics table on this page. The entry index key is **ID**; screen in [Figure 4-2-3-7](#) appears.





**Figure 4-2-3-7: RMON Statistics Configuration Page Screenshot**

The page includes the following fields:

Object	Description
<ul style="list-style-type: none"> <li>• <b>Delete</b></li> </ul>	Check to delete the entry. It will be deleted during the next save.
<ul style="list-style-type: none"> <li>• <b>ID</b></li> </ul>	Indicates the index of the entry. The range is from 1 to 65535.
<ul style="list-style-type: none"> <li>• <b>Data Source</b></li> </ul>	Indicates the port ID which wants to be monitored.

**Buttons**

: Click to add a new community entry.

: Click to apply changes

: Click to undo any changes made locally and revert to previously saved values.

### 4.2.3.8 RMON Statistics Status

This page provides an overview of RMON Statistics entries. Each page shows up to 99 entries from the Statistics table, default being 20, selected through the "entries per page" input field. When first visited, the web page will show the first 20 entries from the beginning of the Statistics table. The first displayed will be the one with the lowest ID found in the Statistics table; screen in [Figure 4-2-3-8](#) appears.

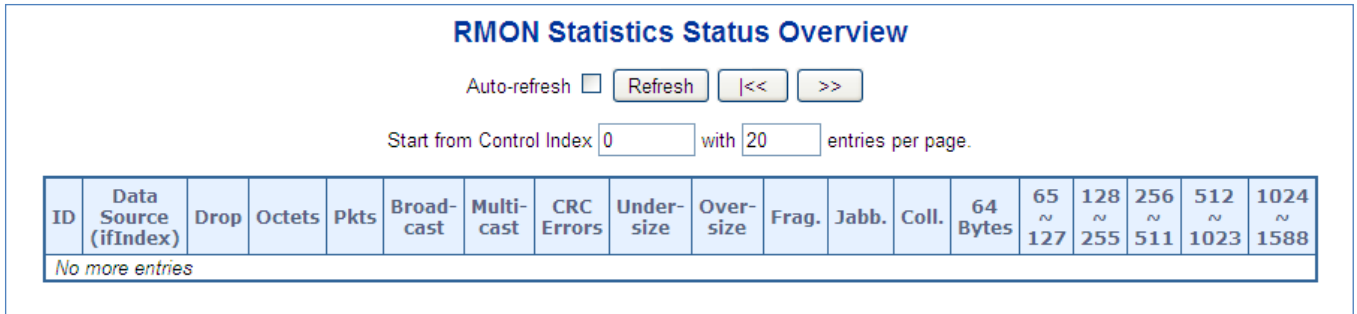

Figure 4-2-3-8: RMON Statistics Status Overview Page Screenshot

The page includes the following fields:

Object	Description
• ID	Indicates the index of Statistics entry.
• Data Source (ifIndex)	The port ID which wants to be monitored.
• Drop	The total number of events in which packets were dropped by the probe due to lack of resources.
• Octets	The total number of octets of data (including those in bad packets) received on the network.
• Pkts	The total number of packets (including bad packets, broadcast packets, and multicast packets) received.
• Broadcast	The total number of good packets received that were directed to the broadcast address.
• Multicast	The total number of good packets received that were directed to a multicast address.
• CRC Errors	The total number of packets received that had a length (excluding framing bits, but including FCS octets) of between 64 and 1518 octets.
• Undersize	The total number of packets received that were less than 64 octets.
• Oversize	The total number of packets received that were longer than 1518 octets.
• Frag.	The number of frames whose size is less than 64 octets received with invalid CRC.
• Jabb.	The number of frames whose size is larger than 64 octets received with invalid CRC.
• Coll.	The best estimate of the total number of collisions in this Ethernet segment.

• <b>64 Bytes</b>	The total number of packets (including bad packets) received that were 64 octets in length.
• <b>65~127</b>	The total number of packets (including bad packets) received that were between 65 to 127 octets in length.
• <b>128~255</b>	The total number of packets (including bad packets) received that were between 128 to 255 octets in length.
• <b>256~511</b>	The total number of packets (including bad packets) received that were between 256 to 511 octets in length.
• <b>512~1023</b>	The total number of packets (including bad packets) received that were between 512 to 1023 octets in length.
• <b>1024~1518</b>	The total number of packets (including bad packets) received that were between 1024 to 1518 octets in length.

**Buttons**

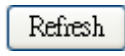
: Click to refresh the page immediately.

Auto-refresh  Check this box to refresh the page automatically. Automatic refresh occurs every 3 seconds.

: Updates the table, starting from the first entry in the Alarm Table, i.e. the entry with the lowest ID.

: Updates the table, starting with the entry after the last entry currently displayed.



## 4.2.4 DHCP server

### 4.2.4.1 DHCP Server Mode Configuration

This page configures **global mode** and **VLAN mode** to enable/disable DHCP server per system and per VLAN. Configure DHCP server mode on this page. The entry index key is **ID**.; screen in [Figure 4-2-4-1](#) appears.

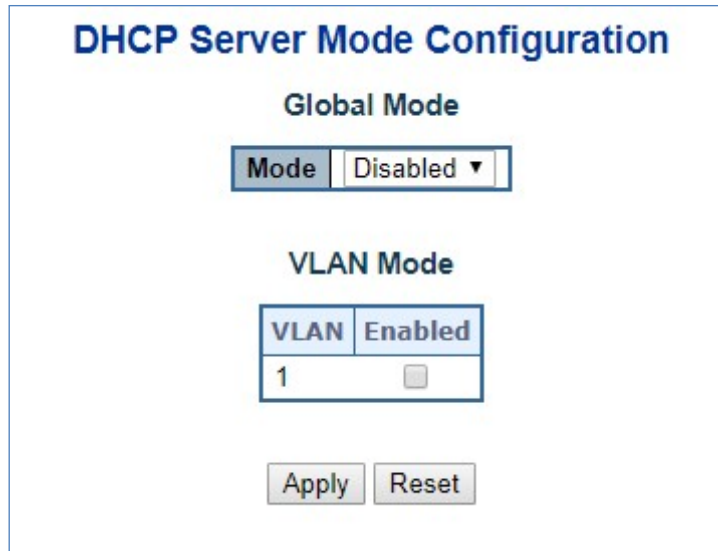

Figure 4-2-4-1: DHCP server mode Page Screenshot

The page includes the following fields:

#### Global Mode

Configure operation mode to enable/disable DHCP server per system.

Object	Description
<ul style="list-style-type: none"> <li>Mode</li> </ul>	Configure the operation mode per system. Possible modes are: <b>Enabled</b> : Enable DHCP server per system. <b>Disabled</b> : Disable DHCP server pre system.

#### VLAN Mode

Configure operation mode to enable/disable DHCP server per VLAN.

Object	Description
<ul style="list-style-type: none"> <li>VLAN Range</li> </ul>	Indicate the VLAN range in which DHCP server is enabled or disabled. The first VLAN ID must be smaller than or equal to the second VLAN ID. BUT, if the VLAN range contains only 1 VLAN ID, then you can just input it into either one of the first and second VLAN ID or both. On the other hand, if you want to disable existed VLAN range, then you can follow the steps.

	<ol style="list-style-type: none"><li>1. press “<b>Add VLANRange</b>” to add a new VLAN range.</li><li>2. input the VLAN range that you want to disable.</li><li>3. choose Mode to be <b>Disabled</b>.</li><li>4. press “<b>Apply</b>” to apply the change.</li></ol> <p>Then, you will see the disabled VLAN range is removed from the DHCP Server mode configuration page.</p>
<ul style="list-style-type: none"><li>• <b>Mode</b></li></ul>	<ul style="list-style-type: none"><li>■ Indicate the operation mode per VLAN. Possible modes are:<ul style="list-style-type: none"><li><b>Enabled</b>: Enable DHCP server per VLAN.</li><li><b>Disabled</b>: Disable DHCP server pre VLAN.</li></ul></li></ul>

**Buttons**

: Click to add a new VLAN range.

: Click to apply changes

: Click to undo any changes made locally and revert to previously saved values.

#### 4.2.4.2 DHCP Server excluded IP Configuration

Configure excluded IP addresses. DHCP server will not allocate these excluded IP addresses to DHCP client.; screen in [Figure 4-2-4-2](#) appears.

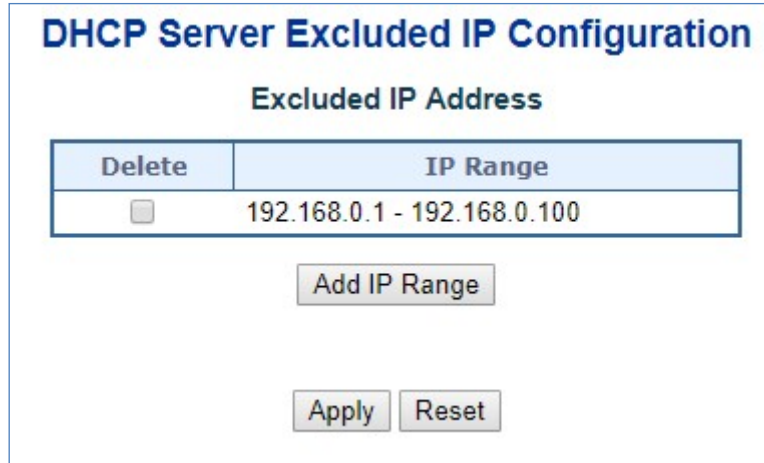

Figure 4-2-4-2: DHCP server excluded Page Screenshot

The page includes the following fields:

Object	Description
<ul style="list-style-type: none"> <li>• <b>IP range</b></li> </ul>	<p>Define the IP range to be excluded IP addresses.</p> <p>The first excluded IP must be smaller than or equal to the second excluded IP.</p> <p>BUT, if the IP range contains only 1 excluded IP, then you can just input it to either one of the first and second excluded IP or both.</p>

#### Buttons

**Add IP Range** : Click to add a new excluded IP range.

**Apply** : Click to apply changes

**Reset** : Click to undo any changes made locally and revert to previously saved values.

### 4.2.4.3 DHCP Server pool Configuration

This page manages DHCP pools. According to the DHCP pool, DHCP server will allocate IP address and deliver configuration parameters to DHCP client. screen in [Figure 4-2-4-3](#) appears.

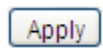



Figure 4-2-4-3: DHCP server pool Page Screenshot

The page includes the following fields:

Object	Description
• Name	Configure the pool name that accepts all printable characters, except white space. If you want to configure the detail settings, you can click the pool name to go into the configuration page.
• Type	Display which type of the pool is. <b>Network:</b> the pool defines a pool of IP addresses to service more than one DHCP client. <b>Host:</b> the pool services for a specific DHCP client identified by client identifier or hardware address.
• IP	Display network number of the DHCP address pool. If "-" is displayed, it means not defined
• Subnet Mask	Display subnet mask of the DHCP address pool. If "-" is displayed, it means not defined.
• Lease Time	Display lease time of the pool.

#### Buttons

-  : Click to add a new excluded IP range.
-  : Click to apply changes
-  : Click to undo any changes made locally and revert to previously saved values.

#### 4.2.4.4 DHCP Server pool Configuration

This page displays the database counters and the number of DHCP messages sent and received by DHCP server.. screen in [Figure 4-2-4-4](#) appears.

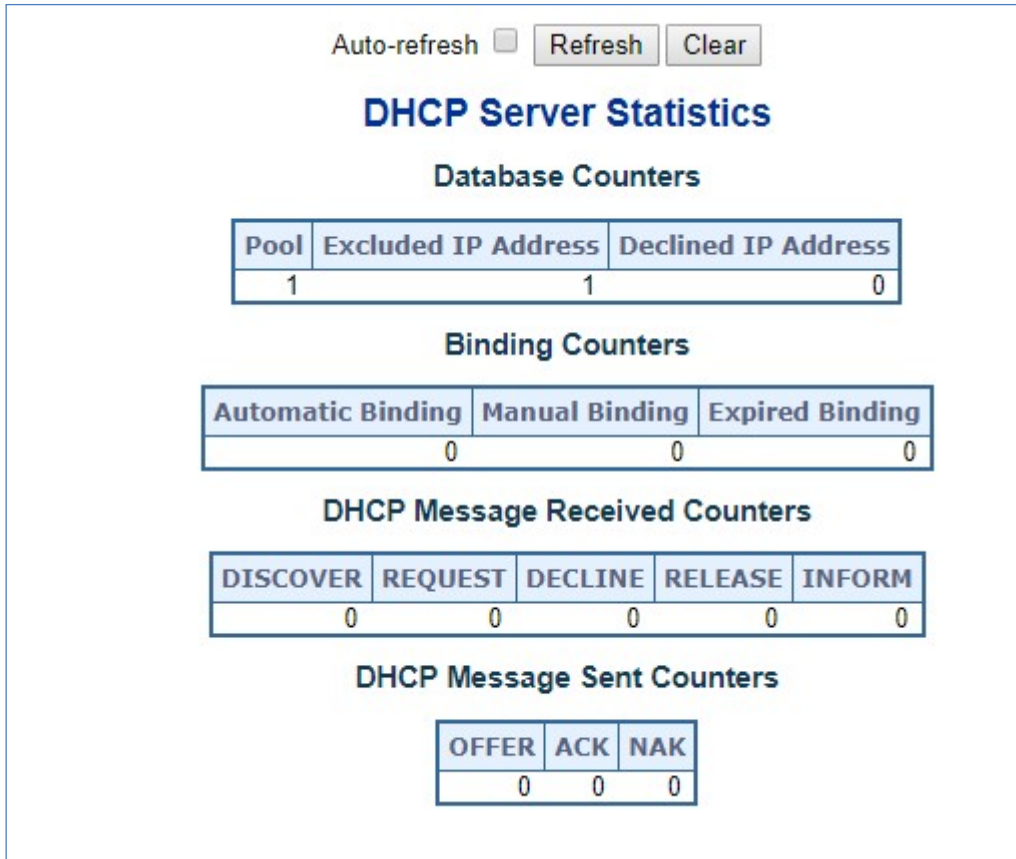

Figure 4-2-4-4: DHCP server Statistics Page Screenshot

The page includes the following fields:

#### Database Counters

Object	Description
• Pool	Number of pools
• Excluded IP Address	Number of excluded IP address ranges
• Declined IP Address	Number of declined IP addresses.

#### Binding Counters

Object	Description
• Automatic Binding	Number of bindings with network-type pools
• Manual Binding	Number of bindings that administrator assigns an IP address to a client. That is, the pool is of host type.

<ul style="list-style-type: none"> <li>• <b>Expired Binding</b></li> </ul>	Number of bindings that their lease time expired or they are cleared from Automatic/Manual type bindings.
--	---

**DHCP message Received Counters**

Object	Description
<ul style="list-style-type: none"> <li>• <b>Discover</b></li> </ul>	Number of DHCP DISCOVER messages received.
<ul style="list-style-type: none"> <li>• <b>Request</b></li> </ul>	Number of DHCP REQUEST messages received.
<ul style="list-style-type: none"> <li>• <b>Decline</b></li> </ul>	Number of DHCP DECLINE messages received.
<ul style="list-style-type: none"> <li>• <b>Release</b></li> </ul>	Number of DHCP RELEASE messages received.
<ul style="list-style-type: none"> <li>• <b>Inform</b></li> </ul>	Number of DHCP INFORM messages received.

**DHCP message Sent Counters**

Object	Description
<ul style="list-style-type: none"> <li>• <b>Offer</b></li> </ul>	Number of DHCP OFFER messages sent.
<ul style="list-style-type: none"> <li>• <b>ACK</b></li> </ul>	Number of DHCP ACK messages sent.
<ul style="list-style-type: none"> <li>• <b>NAK</b></li> </ul>	Number of DHCP NAK messages sent.

**Buttons**

Auto-refresh  seconds. : Check this box to refresh the page automatically.

: Click to apply changes

: Click to undo any changes made locally and revert to previously saved values

#### 4.2.4.5 DHCP Server Binding IP Configuration

This page displays bindings generated for DHCP clients. screen in [Figure 4-2-4-5](#) appears.

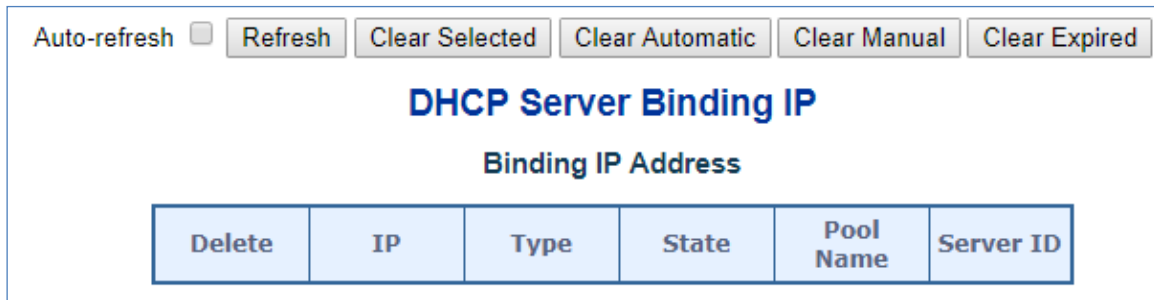

**Figure 4-2-4-5:** DHCP server Binding IP page Screenshot

The page includes the following fields:

Object	Description
• IP	Display IP address allocated to DHCP client.
• Type	Display type of binding. Possible types are Automatic, Manual, Expired.
• State	Display state of binding. Possible states are Committed, Allocated, Expired
• Pool Name	Display the pool that generates the binding.
• Server ID	Display server IP address to service the binding.

#### Buttons

**Auto-refresh**  : Check this box to refresh the page automatically

**Refresh** : Click to refresh the page immediately.

**Clear Selected** : Click to clear selected bindings. If the selected binding is Automatic or Manual, then it is changed to be Expired. If the selected binding is Expired, then it is freed.

**Clear Automatic** : Click to clear all Automatic bindings and Change them to Expired bindings.

**Clear Manual** : Click to clear all Manual bindings and Change them to Expired bindings.

**Clear Expired** : Click to clear all Expired bindings and free them.

#### 4.2.4.6 DHCP Server Declined IP

This page displays declined IP addresses. screen in [Figure 4-2-4-6](#) appears.

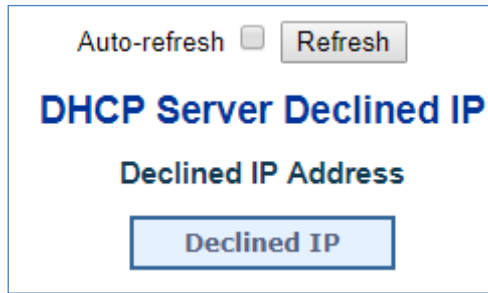

Figure 4-2-4-6: DHCP server Declined IP Page Screenshot

The page includes the following fields:

Object	Description
• Declined IP	Display List of IP addresses declined.

#### Buttons

**Auto-refresh**  : Check this box to refresh the page automatically

**Refresh** : Click to refresh the page immediately.

#### 4.2.4.7 DHCP Detail Statistics

This page provides statistics for DHCP snooping. Notice that the normal forward per-port TX statistics isn't increased if the incoming DHCP packet is done by L3 forwarding mechanism. And clear the statistics on specific port may not take effect on global statistics since it gathers the different layer overview. screen in [Figure 4-2-4-7](#) appears.

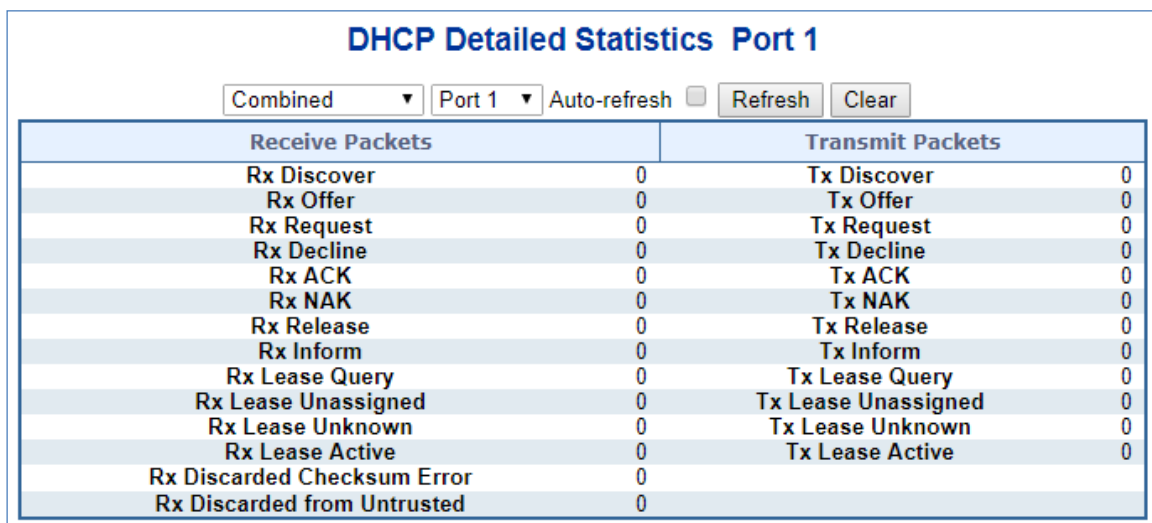

DHCP Detailed Statistics Port 1			
Receive Packets		Transmit Packets	
Rx Discover	0	Tx Discover	0
Rx Offer	0	Tx Offer	0
Rx Request	0	Tx Request	0
Rx Decline	0	Tx Decline	0
Rx ACK	0	Tx ACK	0
Rx NAK	0	Tx NAK	0
Rx Release	0	Tx Release	0
Rx Inform	0	Tx Inform	0
Rx Lease Query	0	Tx Lease Query	0
Rx Lease Unassigned	0	Tx Lease Unassigned	0
Rx Lease Unknown	0	Tx Lease Unknown	0
Rx Lease Active	0	Tx Lease Active	0
Rx Discarded Checksum Error	0		
Rx Discarded from Untrusted	0		

Figure 4-2-4-7: DHCP Detail Statistics page Screenshot



The page includes the following fields:

Object	Description
• Rx and Tx Discover	Display the number of discover (option 53 with value 1) packets received and transmitted.
• Rx and Tx Offer	Display the number of offer (option 53 with value 2) packets received and transmitted.
• Rx and Tx Request	Display the number of request (option 53 with value 3) packets received and transmitted
• Rx and Tx Decline	Display the number of decline (option 53 with value 4) packets received and transmitted.
• Rx and Tx ACK	Display the number of ACK (option 53 with value 5) packets received and transmitted.
• Rx and Tx NAK	Display the number of NAK (option 53 with value 6) packets received and transmitted.
• Rx and Tx Release	Display the number of release (option 53 with value 7) packets received and transmitted.
• Rx and Tx Inform	Display the number of inform (option 53 with value 8) packets received and transmitted
• Rx and Tx Lease Query	Display the number of lease query (option 53 with value 10) packets received and transmitted.
• Rx and Tx Lease Unassigned	Display the number of lease unassigned (option 53 with value 11) packets received and transmitted.
• Rx and Tx Lease Unknown	Display the number of lease unknown (option 53 with value 12) packets received and transmitted.
• Rx and Tx Lease Active	Display the number of lease active (option 53 with value 13) packets received and transmitted
• Rx Discarded checksum error	Display the number of discard packet that IP/UDP checksum is error.
• Rx Discarded from Untrusted	Display the number of discarded packet that are coming from untrusted port.

**Buttons**

**Auto-refresh**  : Check this box to refresh the page automatically

**Refresh** : Click to refresh the page immediately.

**Clear** : Clears the counters for the selected ports

## 4.2.5 Industrial Protocol

With the supported Modbus TCP/IP protocol, the **Industrial Managed Switch** can easily integrate with **SCADA** systems, **HMI** systems and other data acquisition systems in factory floors. It enable administrators to remotely monitor the industrial Ethernet switch's **operating information**, **port information** and **communication status**, thus easily achieving enhanced monitoring and maintenance of the entire factory.

### 4.2.5.1 Protocol Configuration

The Industrial Protocol Configuration are configured here.; screen in [Figure 4-2-5-1](#) appears.

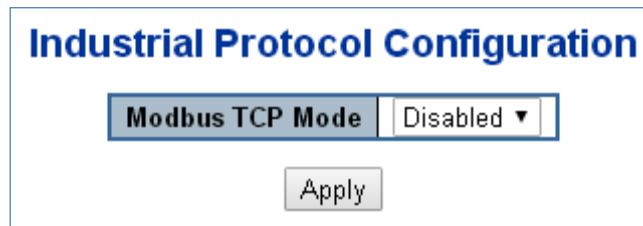

**Figure 4-2-5-1:** Protocol Configuration Page Screenshot

The page includes the following fields:

Object	Description
<ul style="list-style-type: none"> <li>• <b>Modbus TCP Mode</b></li> </ul>	<p>Indicates the modbus TCP mode operation.</p> <p>When the mode operation is enabled, the modbus TCP protocol will be activated.</p> <p>The modbus TCP protocol is based on TCP communication and received on TCP port 502. Possible modes are:</p> <ul style="list-style-type: none"> <li>■ <b>Enabled:</b> Enable modbus TCP mode operation.</li> <li>■ <b>Disabled:</b> Disable modbus TCP mode operation.</li> </ul>

#### Buttons

 : Click to apply changes

## 4.3 Switching

### 4.3.1 Port Management

Use the Port Menu to display or configure the **Industrial Managed Switch's** ports. This section has the following items:

- **Port Configuration** Configures port connection settings
- **Port Statistics Overview** Lists Ethernet and RMON port statistics
- **Port Statistics Detail** Lists Ethernet and RMON port statistics
- **SFP Module Information** Display SFP information
- **Port Mirror** Sets the source and target ports for mirroring

#### 4.3.1.1 Port Configuration

This page displays current port configurations. Ports can also be configured here. The Port Configuration screen in [Figure 4-3-1-1](#) appears.

**Port Configuration**

Port	Port Description	Link	Speed		Flow Control			Maximum Frame Size
			Current	Configured	Enable	Curr Rx	Curr Tx	
*				<All>	<input type="checkbox"/>			10240
1		<span style="color: red;">●</span>	Down	Auto	<input type="checkbox"/>	×	×	10240
2		<span style="color: green;">●</span>	1Gfdx	Auto	<input type="checkbox"/>	×	×	10240
3		<span style="color: red;">●</span>	Down	Auto	<input type="checkbox"/>	×	×	10240
4		<span style="color: red;">●</span>	Down	Auto	<input type="checkbox"/>	×	×	10240
5		<span style="color: red;">●</span>	Down	Auto	<input type="checkbox"/>	×	×	10240
6		<span style="color: red;">●</span>	Down	Auto	<input type="checkbox"/>	×	×	10240
7		<span style="color: red;">●</span>	Down	Auto	<input type="checkbox"/>	×	×	10240
8		<span style="color: red;">●</span>	Down	Auto	<input type="checkbox"/>	×	×	10240

**Figure 4-3-1-1:** Port Configuration Page Screenshot

The page includes the following fields:

Object	Description
• <b>Port</b>	This is the logical port number for this row.
• <b>Port Description</b>	Indicates the per port description.
• <b>Link</b>	The current link state is displayed graphically. Green indicates the link is up and red indicates the link is down.
• <b>Current Link Speed</b>	Provides the current link speed of the port.

<ul style="list-style-type: none"> <li>• <b>Configured Link Speed</b></li> </ul>	<p>Select any available link speed for the given switch port. Draw the menu bar to select the mode.</p> <ul style="list-style-type: none"> <li>■ <b>Auto</b> - Set up Auto negotiation for copper interface.</li> <li>■ <b>10Mbps HDX</b> - Force sets 10Mbps/Half-Duplex mode.</li> <li>■ <b>10Mbps FDX</b> - Force sets 10Mbps/Full-Duplex mode.</li> <li>■ <b>100Mbps HDX</b> - Force sets 100Mbps/Half-Duplex mode.</li> <li>■ <b>100Mbps FDX</b> - Force sets 100Mbps/Full-Duplex mode.</li> <li>■ <b>1Gbps FDX</b> - Force sets 1000Mbps/Full-Duplex mode.</li> <li>■ <b>1G FDX</b> - Forces sets 1Gbps/Full-Duplex mode.</li> <li>■ <b>10G FDX</b> - Forces sets 10Gbps/Full-Duplex mode.</li> <li>■ <b>Disable</b> - Shut down the port manually.</li> </ul>
<ul style="list-style-type: none"> <li>• <b>Flow Control</b></li> </ul>	<p>When <b>Auto Speed</b> is selected on a port, this section indicates the flow control capability that is advertised to the link partner.</p> <p>When a fixed-speed setting is selected, that is what is used. The Current Rx column indicates whether pause frames on the port are obeyed, and the Current Tx column indicates whether pause frames on the port are transmitted. The Rx and Tx settings are determined by the result of the last Auto-Negotiation.</p> <p>Check the configured column to use flow control. This setting is related to the setting for Configured Link Speed.</p>
<ul style="list-style-type: none"> <li>• <b>Maximum Frame Size</b></li> </ul>	<p>Enter the maximum frame size allowed for the switch port, including FCS. The allowed range is 1518 bytes to 10056 bytes.</p>



When setting each port to run at 100M Full-, 100M Half-, 10M Full-, and 10M Half-speed modes. The Auto-MDIX function will disable.

**Buttons**

**Apply** : Click to apply changes

**Reset** : Click to undo any changes made locally and revert to previously saved values.

**Refresh** : Click to refresh the page. Any changes made locally will be undone.

### 4.3.1.2 Port Statistics Overview

This page provides an overview of general traffic statistics for all switch ports. The Port Statistics Overview screen in [Figure 4-3-1-2](#) appears.

Port	Packets		Bytes		Errors		Drops		Filtered
	Received	Transmitted	Received	Transmitted	Received	Transmitted	Received	Transmitted	Received
1	1076	1047	158972	862468	0	0	0	0	0
2	0	0	0	0	0	0	0	0	0
3	0	0	0	0	0	0	0	0	0
4	0	0	0	0	0	0	0	0	0
5	0	0	0	0	0	0	0	0	0
6	0	0	0	0	0	0	0	0	0
7	0	0	0	0	0	0	0	0	0
8	0	0	0	0	0	0	0	0	0

**Figure 4-3-1-2:** Port Statistics Overview Page Screenshot

The displayed counters are:

Object	Description
• <b>Port</b>	The logical port for the settings contained in the same row.
• <b>Packets</b>	The number of received and transmitted packets per port.
• <b>Bytes</b>	The number of received and transmitted bytes per port.
• <b>Errors</b>	The number of frames received in error and the number of incomplete transmissions per port.
• <b>Drops</b>	The number of frames discarded due to ingress or egress congestion.
• <b>Filtered</b>	The number of received frames filtered by the forwarding process.

#### Buttons

: Download the Port Statistics Overview result in EXCEL file.

: Click to refresh the page immediately.

: Clears the counters for all ports.

: Print the Port Statistics Overview result.

Auto-refresh  : Check this box to enable an automatic refresh of the page at regular intervals.

### 4.3.1.3 Port Statistics Details

This page provides detailed traffic statistics for a specific switch port. Use the port select box to select which switch port details to display. The displayed counters are the totals for receive and transmit, the size counters for receive and transmit, and the error counters for receive and transmit. The Detailed Port Statistics screen in [Figure 4-3-1-3](#) appears.

Detailed Port Statistics Port 1			
Port 1		Auto-refresh <input type="checkbox"/>	Refresh Clear
Receive Total		Transmit Total	
Rx Packets	2335	Tx Packets	2066
Rx Octets	431172	Tx Octets	1531131
Rx Unicast	2039	Tx Unicast	2050
Rx Multicast	48	Tx Multicast	11
Rx Broadcast	248	Tx Broadcast	5
Rx Pause	0	Tx Pause	0
Receive Size Counters		Transmit Size Counters	
Rx 64 Bytes	1465	Tx 64 Bytes	242
Rx 65-127 Bytes	175	Tx 65-127 Bytes	53
Rx 128-255 Bytes	66	Tx 128-255 Bytes	523
Rx 256-511 Bytes	553	Tx 256-511 Bytes	203
Rx 512-1023 Bytes	76	Tx 512-1023 Bytes	284
Rx 1024-1526 Bytes	0	Tx 1024-1526 Bytes	761
Rx 1527- Bytes	0	Tx 1527- Bytes	0
Receive Queue Counters		Transmit Queue Counters	
Rx Q0	2283	Tx Q0	0
Rx Q1	0	Tx Q1	0
Rx Q2	0	Tx Q2	0
Rx Q3	0	Tx Q3	0
Rx Q4	0	Tx Q4	0
Rx Q5	0	Tx Q5	0
Rx Q6	0	Tx Q6	0
Rx Q7	0	Tx Q7	2066
Receive Error Counters		Transmit Error Counters	
Rx Drops	52	Tx Drops	0
Rx CRC/Alignment	0	Tx Late/Exc. Coll.	0
Rx Undersize	0		
Rx Oversize	0		
Rx Fragments	0		
Rx Jabber	0		
Rx Filtered	52		

Figure 4-3-1-3: Detailed Port Statistics Port 1 Page Screenshot

The page includes the following fields:

#### Receive Total and Transmit Total

Object	Description
• Rx and Tx Packets	The number of received and transmitted (good and bad) packets
• Rx and Tx Octets	The number of received and transmitted (good and bad) bytes, including FCS, but excluding framing bits.
• Rx and Tx Unicast	The number of received and transmitted (good and bad) unicast packets.
• Rx and Tx Multicast	The number of received and transmitted (good and bad) multicast packets.
• Rx and Tx Broadcast	The number of received and transmitted (good and bad) broadcast packets.
• Rx and Tx Pause	A count of the MAC Control frames received or transmitted on this port that has an opcode indicating a PAUSE operation.

### Receive and Transmit Size Counters

The number of received and transmitted (good and bad) packets split into categories based on their respective frame sizes.

### Receive and Transmit Queue Counters

The number of received and transmitted packets per input and output queue.

### Receive Error Counters

Object	Description
• Rx Drops	The number of frames dropped due to lack of receive buffers or egress congestion.
• Rx CRC/Alignment	The number of frames received with CRC or alignment errors.
• Rx Undersize	The number of short frames received with valid CRC.
• Rx Oversize	The number of long frames received with valid CRC.
• Rx Fragments	The number of short frames received with invalid CRC.
• Rx Jabber	The number of long frames received with invalid CRC.
• Rx Filtered	The number of received frames filtered by the forwarding process.  Short frames are frames that are smaller than 64 bytes. Long frames are frames that are longer than the configured maximum frame length for this port.



- 1 Short frames are frames that are smaller than 64 bytes.
- 2 Long frames are frames that are longer than the configured maximum frame length for this port.

### Transmit Error Counters

Object	Description
• Tx Drops	The number of frames dropped due to output buffer congestion.
• Tx Late/Exc. Coll.	The number of frames dropped due to excessive or late collisions.

### Buttons

: Click to refresh the page immediately.

: Clears the counters for all ports.

Auto-refresh  : Check this box to enable an automatic refresh of the page at regular intervals.

### 4.3.1.4 SFP Module Information

The **Industrial Managed Switches** have supported the SFP module with **digital diagnostics monitoring (DDM)** function. This feature is also known as digital optical monitoring (DOM). You can check the physical or operational status of an SFP module via the SFP Module Information page. This page shows the operational status, such as the transceiver type, speed, wavelength, optical output power, optical input power, temperature, laser bias current and transceiver supply voltage in real time. You can also use the hyperlink of port no. to check the statistics on a specific interface. The SFP Module Information screen in [Figure 4-3-1-4](#) appears.

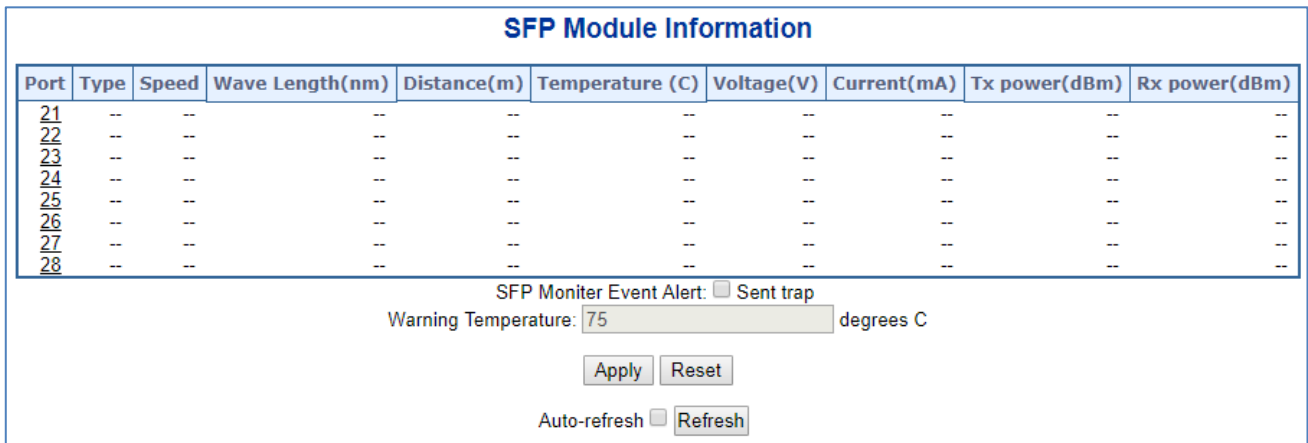

**Figure 4-3-1-4:** SFP Module Information for Switch Page Screenshot

The page includes the following fields:

Object	Description
<ul style="list-style-type: none"> <li><b>Type</b></li> </ul>	Display the type of current SFP module; the possible types are: <ul style="list-style-type: none"> <li>■ 10GBASE-SR</li> <li>■ 10GBASE-LR</li> <li>■ 1000BASE-SX</li> <li>■ 1000BASE-LX</li> <li>■ 100BASE-FX</li> </ul>
<ul style="list-style-type: none"> <li><b>Speed</b></li> </ul>	Display the speed of current SFP module; the speed value or description is got from the SFP module. Different vendors SFP modules might show different speed information.
<ul style="list-style-type: none"> <li><b>Wave Length (nm)</b></li> </ul>	Display the wavelength of current SFP module; the wavelength value is got from the SFP module. Use this column to check if the wavelength values of two nodes are matched while the fiber connection failed.
<ul style="list-style-type: none"> <li><b>Distance (m)</b></li> </ul>	Display the support distance of current SFP module; the distance value is got from the SFP module.
<ul style="list-style-type: none"> <li><b>Temperature (C)</b></li> <li>– SFP DDM Module Only</li> </ul>	Display the temperature of current SFP DDM module; the temperature value is got from the SFP DDM module.
<ul style="list-style-type: none"> <li><b>Voltage(V)</b></li> <li>– SFP DDM Module Only</li> </ul>	Display the voltage of current SFP DDM module; the voltage value is got from the SFP DDM module.



<ul style="list-style-type: none"> <li>• <b>Current(mA)</b> – SFP DDM Module Only</li> </ul>	Display the Ampere of current SFP DDM module; the Ampere value is got from the SFP DDM module.
<ul style="list-style-type: none"> <li>• <b>TX power (dBm)</b> – SFP DDM Module Only</li> </ul>	Display the TX power of current SFP DDM module; the TX power value is got from the SFP DDM module.
<ul style="list-style-type: none"> <li>• <b>RX power (dBm)</b> – SFP DDM Module Only</li> </ul>	Display the RX power of current SFP DDM module; the RX power value is got from the SFP DDM module.

**Buttons**

SFP Monitor Event Alert:  send trap

Warning Temperature:  degrees C

Check SFP Monitor Event Alert box; it will be in accordance with your warning temperature setting and allows users to record message out via SNMP Trap.

Auto-refresh  : Check this box to enable an automatic refresh of the page at regular intervals.

: Click to apply changes

: Click to undo any changes made locally and revert to previously saved values.

: Click to refresh the page immediately.

**4.3.1.5 Port Mirror**

Configure port Mirroring on this page. This function provides monitoring network traffic that forwards a copy of each incoming or outgoing packet from one port of a network Switch to another port where the packet can be studied. It enables the manager to keep close track of switch performance and alter it if necessary.

- To debug network problems, selected traffic can be copied, or mirrored, to a mirror port where a frame analyzer can be attached to analyze the frame flow.
- The **Industrial Managed Switch** can unobtrusively mirror traffic from any port to a monitor port. You can then attach a protocol analyzer or RMON probe to this port to perform traffic analysis and verify connection integrity.

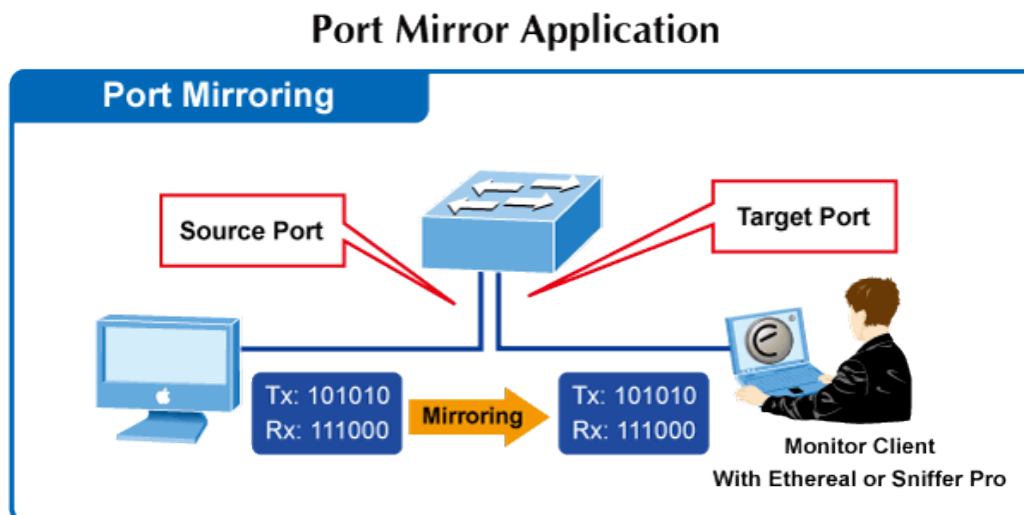

Figure 4-3-1-5: Port Mirror Application

The traffic to be copied to the mirror port is selected as follows:

- All frames received on a given port (also known as ingress or source mirroring).
- All frames transmitted on a given port (also known as egress or destination mirroring).

### Mirror Port Configuration

The Port Mirror screen in [Figure 4-3-1-6](#) appears, and click the session ID to [Figure 4-3-1-7](#)

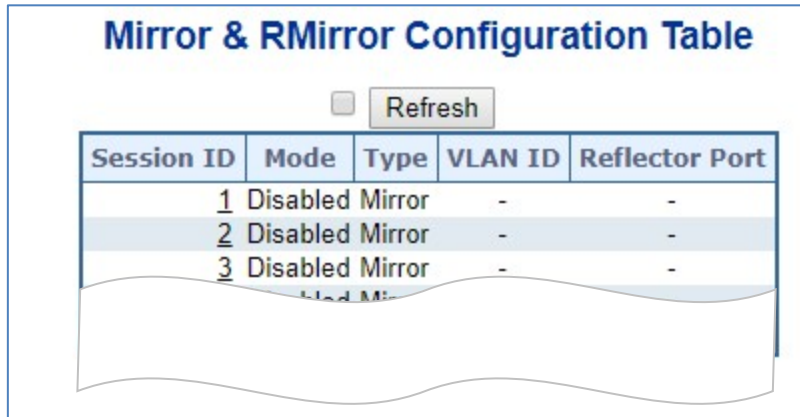

Figure 4-3-1-6: Mirror Configuration Page Screenshot

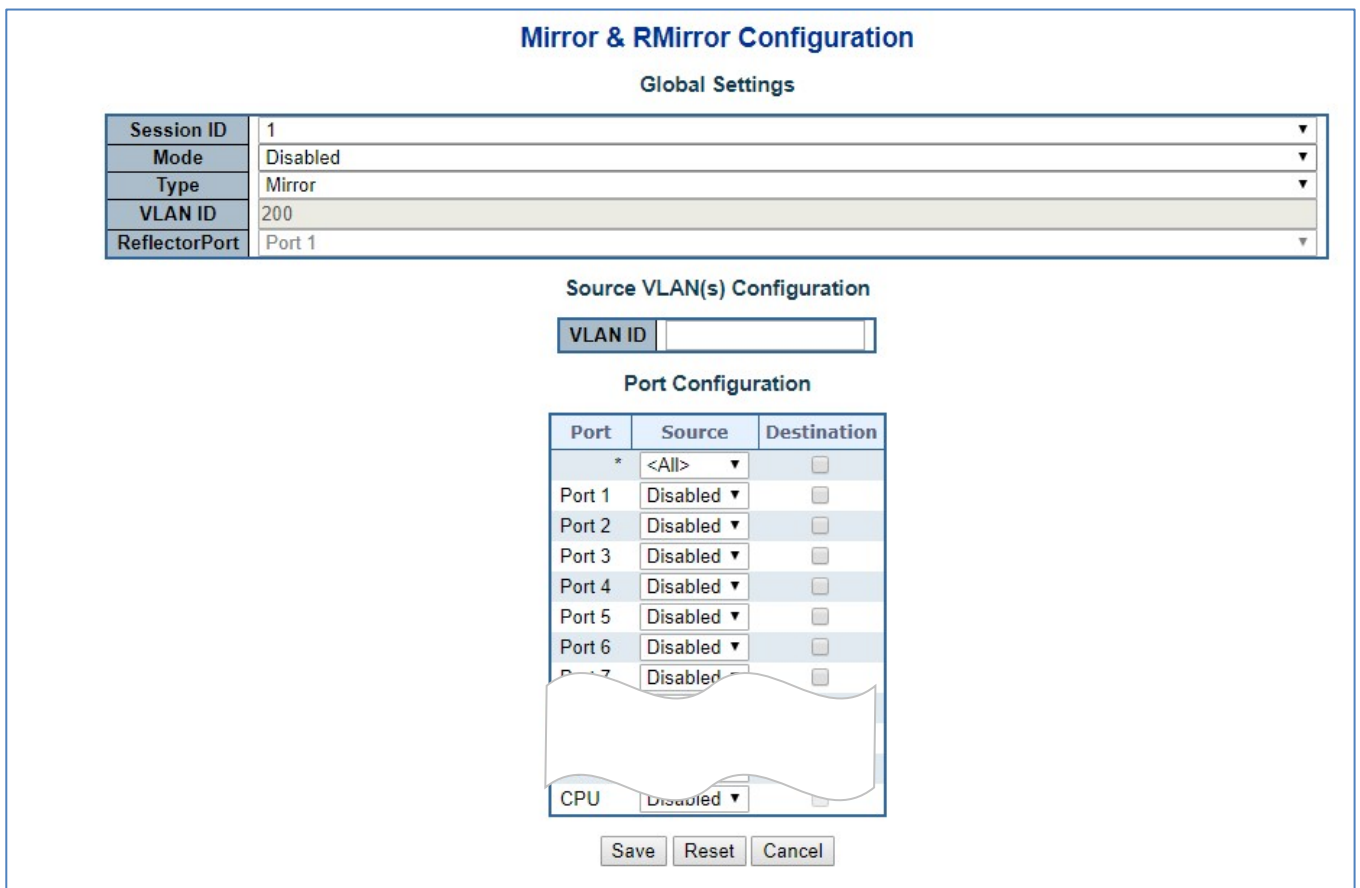

Figure 4-3-1-7: Mirror Configuration Page Screenshot

The page includes the following fields:

Object	Description
• Session	Select session id to configure.
• Mode	To Enabled/Disabled the mirror or Remote Mirroring function
• Type	<p><b>Mirror</b></p> <p>The switch is running on mirror mode. The <a href="#">source port(s)</a> and <a href="#">destination port</a> are located on this switch.</p> <p><b>Source</b></p> <p>The switch is a source node for monitor flow. The <a href="#">source port(s)</a>, <a href="#">reflector port</a> are located on this switch.</p> <p><b>RMirror destination</b></p> <p>The switch is an end node for monitor flow. The <a href="#">destination port(s)</a> is located on this switch.</p>
• VLAN ID	The VLAN ID points out where the monitor packet will copy to. The default VLAN ID is 200.
• Reflector Port	<p>The reflector port is a method to redirect the traffic to Remote Mirroring VLAN. Any device connected to a port set as a reflector port loses connectivity until the Remote Mirroring is disabled.</p> <p>In the stacking mode, you need to select switch ID to select the correct device.</p> <p>If you shut down a port, it cannot be a candidate for reflector port.</p> <p>If you shut down the port which is a reflector port, the remote mirror function cannot work</p>
• Source VLAN(s) Configuration	The switch can supports VLAN-based Mirroring. If you want to monitor some VLANs on the switch, you can set the selected VLANs on this field.
• Remote Mirroring Port Configuration	<p>The following table is used for port role selecting.</p> <ul style="list-style-type: none"> <li>■ <b>Port:</b> The logical port for the settings contained in the same row..</li> <li>■ <b>Source:</b> Select mirror mode. <ul style="list-style-type: none"> <li><b>Disabled</b> Neither frames transmitted nor frames received are mirrored.</li> <li><b>Both</b> Frames received and frames transmitted are mirrored on the <b>Destination port</b>.</li> <li><b>Rx only</b> Frames received on this port are mirrored on the <b>Destination port</b>. Frames transmitted are not mirrored.</li> <li><b>Tx only</b> Frames transmitted on this port are mirrored on the <b>Destination port</b>. Frames received are not mirrored</li> </ul> </li> <li>■ <b>Destination:</b> Select destination port. This checkbox is designed for mirror or Remote Mirroring. The <b>destination port</b> is a switched port that you receive a copy of traffic from the source port.</li> </ul>





---

For a given port, a frame is only transmitted once. It is therefore not possible to mirror Tx frames on the **mirror port**. Because of this, **mode** for the selected mirror port is limited to **Disabled** or **Rx only**.

---

#### Buttons

 **Apply** : Click to apply changes

 **Reset** : Click to undo any changes made locally and revert to previously saved values.

### 4.3.2 Link Aggregation

Port Aggregation optimizes port usage by linking a group of ports together to form a single Link Aggregated Groups (LAGs). Port Aggregation multiplies the bandwidth between the devices, increases port flexibility, and provides link redundancy.

Each LAG is composed of ports of the same speed, set to full-duplex operations. Ports in a LAG, can be of different media types (UTP/Fiber, or different fiber types), provided they operate at the same speed.

Aggregated Links can be assigned manually (**Port Trunk**) or automatically by enabling Link Aggregation Control Protocol (**LACP**) on the relevant links.

Aggregated Links are treated by the system as a single logical port. Specifically, the Aggregated Link has similar port attributes to a non-aggregated port, including auto-negotiation, speed, Duplex setting, etc.

The device supports the following Aggregation links :

- **Static LAGs (Port Trunk)** – Force aggregated selected ports to be a trunk group.
- **Link Aggregation Control Protocol (LACP) LAGs** - LACP LAG negotiate Aggregated Port links with other LACP ports located on a different device. If the other device ports are also LACP ports, the devices establish a LAG between them.

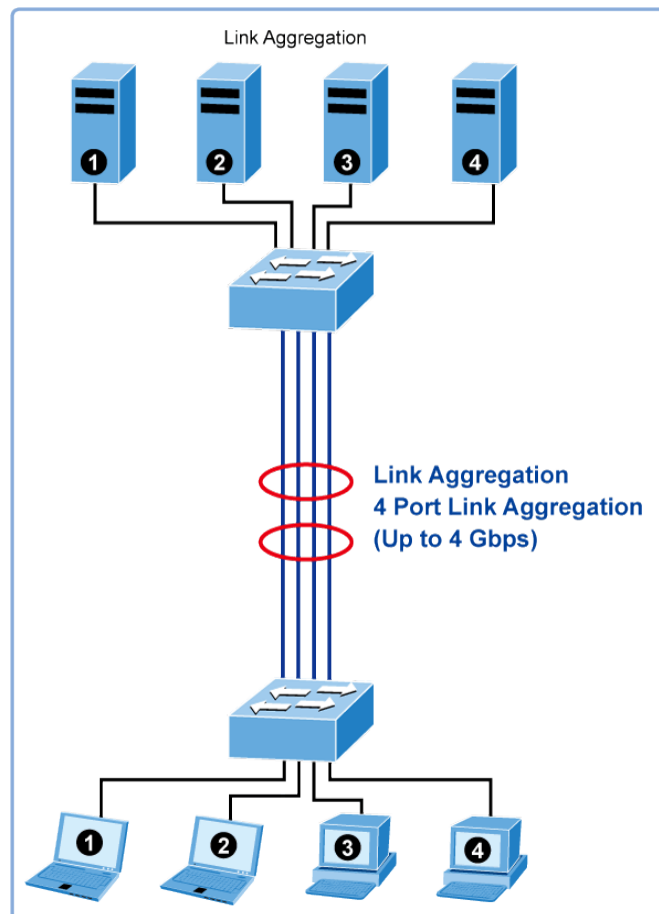

**Figure 4-3-2-1:** Link Aggregation



The **Link Aggregation Control Protocol (LACP)** provides a standardized means for exchanging information between Partner Systems that require high speed redundant links. Link aggregation lets you group up to eight consecutive ports into a single dedicated connection. This feature can expand bandwidth to a device on the network. LACP operation requires full-duplex mode, more detail information refer to the IEEE 802.3ad standard.

Port link aggregations can be used to increase the bandwidth of a network connection or to ensure fault recovery. Link aggregation lets you group up to 4 consecutive ports into a single dedicated connection between any two the Switch or other Layer 2 switches. However, before making any physical connections between devices, use the Link aggregation Configuration menu to specify the link aggregation on the devices at both ends. When using a port link aggregation, note that:

- The ports used in a link aggregation must all be of the same media type (RJ45, 100 Mbps fiber).
- The ports that can be assigned to the same link aggregation have certain other restrictions (see below).
- Ports can only be assigned to one link aggregation.
- The ports at both ends of a connection must be configured as link aggregation ports.
- None of the ports in a link aggregation can be configured as a mirror source port or a mirror target port.
- All of the ports in a link aggregation have to be treated as a whole when moved from/to, added or deleted from a VLAN.
- The Spanning Tree Protocol will treat all the ports in a link aggregation as a whole.
- Enable the link aggregation prior to connecting any cable between the switches to avoid creating a data loop.
- Disconnect all link aggregation port cables or disable the link aggregation ports before removing a port link aggregation to avoid creating a data loop.

It allows a maximum of 10 ports to be aggregated at the same time. The **Industrial Managed Switch** support Gigabit Ethernet ports (up to 5 groups). If the group is defined as a LACP static link aggregation group, then any extra ports selected are placed in a standby mode for redundancy if one of the other ports fails. If the group is defined as a local static link aggregation group, then the number of ports must be the same as the group member ports.

The aggregation code ensures that frames belonging to the same frame flow (for example, a TCP connection) are always forwarded on the same link aggregation member port. Recording of frames within a flow is therefore not possible. The aggregation code is based on the following information:

- **Source MAC**
- **Destination MAC**
- **Source and destination IPv4 address.**
- **Source and destination TCP/UDP ports for IPv4 packets**

Normally, all 5 contributions to the aggregation code should be enabled to obtain the best traffic distribution among the link aggregation member ports. Each link aggregation may consist of up to 10 member ports. Any quantity of link aggregation s may be configured for the device (only limited by the quantity of ports on the device.) To configure a proper traffic distribution, the ports within a link aggregation must use the same link speed.

### 4.3.2.1 Static Aggregation

This page is used to configure the Aggregation hash mode and the aggregation group. The aggregation hash mode settings are global.

#### Hash Code Contributors

The Static Aggregation screen in [Figure 4-3-2-2](#) appears.

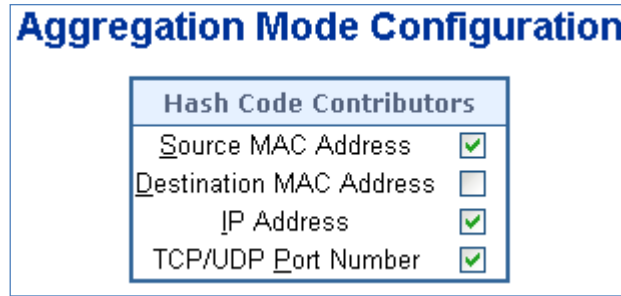

Figure 4-3-2-2 : Aggregation Mode Configuration Page Screenshot

The page includes the following fields:

Object	Description
<ul style="list-style-type: none"> <li>Source MAC Address</li> </ul>	The Source MAC address can be used to calculate the destination port for the frame. Check to enable the use of the Source MAC address, or uncheck to disable. By default, Source MAC Address is enabled.
<ul style="list-style-type: none"> <li>Destination MAC Address</li> </ul>	The Destination MAC Address can be used to calculate the destination port for the frame. Check to enable the use of the Destination MAC Address, or uncheck to disable. By default, Destination MAC Address is disabled.
<ul style="list-style-type: none"> <li>IP Address</li> </ul>	The IP address can be used to calculate the destination port for the frame. Check to enable the use of the IP Address, or uncheck to disable. By default, IP Address is enabled.
<ul style="list-style-type: none"> <li>TCP/UDP Port Number</li> </ul>	The TCP/UDP port number can be used to calculate the destination port for the frame. Check to enable the use of the TCP/UDP Port Number, or uncheck to disable. By default, TCP/UDP Port Number is enabled.

#### Static Aggregation Group Configuration

The Aggregation Group Configuration screen in [Figure 4-3-2-3](#) appears.



Aggregation Group Configuration																																		
Group ID	Port Members																												Group Configuration					
	1	2	3	4	5	6	7	8	9	10	11	12	13	14	15	16	17	18	19	20	21	22	23	24	25	26	27	28	Mode	Revertive	Max Bundle			
Normal	<input checked="" type="radio"/>	<input checked="" type="radio"/>	<input checked="" type="radio"/>	<input checked="" type="radio"/>	<input checked="" type="radio"/>	<input checked="" type="radio"/>	<input checked="" type="radio"/>	<input checked="" type="radio"/>	<input checked="" type="radio"/>	<input checked="" type="radio"/>	<input checked="" type="radio"/>	<input checked="" type="radio"/>	<input checked="" type="radio"/>	<input checked="" type="radio"/>	<input checked="" type="radio"/>	<input checked="" type="radio"/>	<input checked="" type="radio"/>	<input checked="" type="radio"/>	<input checked="" type="radio"/>	<input checked="" type="radio"/>	<input checked="" type="radio"/>	<input checked="" type="radio"/>	<input checked="" type="radio"/>	<input checked="" type="radio"/>	<input checked="" type="radio"/>	<input checked="" type="radio"/>	<input checked="" type="radio"/>	<input checked="" type="radio"/>	<input checked="" type="radio"/>	<input checked="" type="radio"/>	<input checked="" type="radio"/>	Disabled	<input checked="" type="checkbox"/>	16
1	<input type="radio"/>	<input type="radio"/>	<input type="radio"/>	<input type="radio"/>	<input type="radio"/>	<input type="radio"/>	<input type="radio"/>	<input type="radio"/>	<input type="radio"/>	<input type="radio"/>	<input type="radio"/>	<input type="radio"/>	<input type="radio"/>	<input type="radio"/>	<input type="radio"/>	<input type="radio"/>	<input type="radio"/>	<input type="radio"/>	<input type="radio"/>	<input type="radio"/>	<input type="radio"/>	<input type="radio"/>	<input type="radio"/>	<input type="radio"/>	<input type="radio"/>	<input type="radio"/>	<input type="radio"/>	<input type="radio"/>	<input type="radio"/>	<input type="radio"/>	<input type="radio"/>	Disabled	<input checked="" type="checkbox"/>	16
2	<input type="radio"/>	<input type="radio"/>	<input type="radio"/>	<input type="radio"/>	<input type="radio"/>	<input type="radio"/>	<input type="radio"/>	<input type="radio"/>	<input type="radio"/>	<input type="radio"/>	<input type="radio"/>	<input type="radio"/>	<input type="radio"/>	<input type="radio"/>	<input type="radio"/>	<input type="radio"/>	<input type="radio"/>	<input type="radio"/>	<input type="radio"/>	<input type="radio"/>	<input type="radio"/>	<input type="radio"/>	<input type="radio"/>	<input type="radio"/>	<input type="radio"/>	<input type="radio"/>	<input type="radio"/>	<input type="radio"/>	<input type="radio"/>	<input type="radio"/>	<input type="radio"/>	Disabled	<input checked="" type="checkbox"/>	16
3	<input type="radio"/>	<input type="radio"/>	<input type="radio"/>	<input type="radio"/>	<input type="radio"/>	<input type="radio"/>	<input type="radio"/>	<input type="radio"/>	<input type="radio"/>	<input type="radio"/>	<input type="radio"/>	<input type="radio"/>	<input type="radio"/>	<input type="radio"/>	<input type="radio"/>	<input type="radio"/>	<input type="radio"/>	<input type="radio"/>	<input type="radio"/>	<input type="radio"/>	<input type="radio"/>	<input type="radio"/>	<input type="radio"/>	<input type="radio"/>	<input type="radio"/>	<input type="radio"/>	<input type="radio"/>	<input type="radio"/>	<input type="radio"/>	<input type="radio"/>	<input type="radio"/>	Disabled	<input checked="" type="checkbox"/>	16
4	<input type="radio"/>	<input type="radio"/>	<input type="radio"/>	<input type="radio"/>	<input type="radio"/>	<input type="radio"/>	<input type="radio"/>	<input type="radio"/>	<input type="radio"/>	<input type="radio"/>	<input type="radio"/>	<input type="radio"/>	<input type="radio"/>	<input type="radio"/>	<input type="radio"/>	<input type="radio"/>	<input type="radio"/>	<input type="radio"/>	<input type="radio"/>	<input type="radio"/>	<input type="radio"/>	<input type="radio"/>	<input type="radio"/>	<input type="radio"/>	<input type="radio"/>	<input type="radio"/>	<input type="radio"/>	<input type="radio"/>	<input type="radio"/>	<input type="radio"/>	<input type="radio"/>	Disabled	<input checked="" type="checkbox"/>	16
5	<input type="radio"/>	<input type="radio"/>	<input type="radio"/>	<input type="radio"/>	<input type="radio"/>	<input type="radio"/>	<input type="radio"/>	<input type="radio"/>	<input type="radio"/>	<input type="radio"/>	<input type="radio"/>	<input type="radio"/>	<input type="radio"/>	<input type="radio"/>	<input type="radio"/>	<input type="radio"/>	<input type="radio"/>	<input type="radio"/>	<input type="radio"/>	<input type="radio"/>	<input type="radio"/>	<input type="radio"/>	<input type="radio"/>	<input type="radio"/>	<input type="radio"/>	<input type="radio"/>	<input type="radio"/>	<input type="radio"/>	<input type="radio"/>	<input type="radio"/>	<input type="radio"/>	Disabled	<input checked="" type="checkbox"/>	16
6	<input type="radio"/>	<input type="radio"/>	<input type="radio"/>	<input type="radio"/>	<input type="radio"/>	<input type="radio"/>	<input type="radio"/>	<input type="radio"/>	<input type="radio"/>	<input type="radio"/>	<input type="radio"/>	<input type="radio"/>	<input type="radio"/>	<input type="radio"/>	<input type="radio"/>	<input type="radio"/>	<input type="radio"/>	<input type="radio"/>	<input type="radio"/>	<input type="radio"/>	<input type="radio"/>	<input type="radio"/>	<input type="radio"/>	<input type="radio"/>	<input type="radio"/>	<input type="radio"/>	<input type="radio"/>	<input type="radio"/>	<input type="radio"/>	<input type="radio"/>	<input type="radio"/>	Disabled	<input checked="" type="checkbox"/>	16
7	<input type="radio"/>	<input type="radio"/>	<input type="radio"/>	<input type="radio"/>	<input type="radio"/>	<input type="radio"/>	<input type="radio"/>	<input type="radio"/>	<input type="radio"/>	<input type="radio"/>	<input type="radio"/>	<input type="radio"/>	<input type="radio"/>	<input type="radio"/>	<input type="radio"/>	<input type="radio"/>	<input type="radio"/>	<input type="radio"/>	<input type="radio"/>	<input type="radio"/>	<input type="radio"/>	<input type="radio"/>	<input type="radio"/>	<input type="radio"/>	<input type="radio"/>	<input type="radio"/>	<input type="radio"/>	<input type="radio"/>	<input type="radio"/>	<input type="radio"/>	<input type="radio"/>	Disabled	<input checked="" type="checkbox"/>	16
8	<input type="radio"/>	<input type="radio"/>	<input type="radio"/>	<input type="radio"/>	<input type="radio"/>	<input type="radio"/>	<input type="radio"/>	<input type="radio"/>	<input type="radio"/>	<input type="radio"/>	<input type="radio"/>	<input type="radio"/>	<input type="radio"/>	<input type="radio"/>	<input type="radio"/>	<input type="radio"/>	<input type="radio"/>	<input type="radio"/>	<input type="radio"/>	<input type="radio"/>	<input type="radio"/>	<input type="radio"/>	<input type="radio"/>	<input type="radio"/>	<input type="radio"/>	<input type="radio"/>	<input type="radio"/>	<input type="radio"/>	<input type="radio"/>	<input type="radio"/>	<input type="radio"/>	Disabled	<input checked="" type="checkbox"/>	16
9	<input type="radio"/>	<input type="radio"/>	<input type="radio"/>	<input type="radio"/>	<input type="radio"/>	<input type="radio"/>	<input type="radio"/>	<input type="radio"/>	<input type="radio"/>	<input type="radio"/>	<input type="radio"/>	<input type="radio"/>	<input type="radio"/>	<input type="radio"/>	<input type="radio"/>	<input type="radio"/>	<input type="radio"/>	<input type="radio"/>	<input type="radio"/>	<input type="radio"/>	<input type="radio"/>	<input type="radio"/>	<input type="radio"/>	<input type="radio"/>	<input type="radio"/>	<input type="radio"/>	<input type="radio"/>	<input type="radio"/>	<input type="radio"/>	<input type="radio"/>	<input type="radio"/>	Disabled	<input checked="" type="checkbox"/>	16
10	<input type="radio"/>	<input type="radio"/>	<input type="radio"/>	<input type="radio"/>	<input type="radio"/>	<input type="radio"/>	<input type="radio"/>	<input type="radio"/>	<input type="radio"/>	<input type="radio"/>	<input type="radio"/>	<input type="radio"/>	<input type="radio"/>	<input type="radio"/>	<input type="radio"/>	<input type="radio"/>	<input type="radio"/>	<input type="radio"/>	<input type="radio"/>	<input type="radio"/>	<input type="radio"/>	<input type="radio"/>	<input type="radio"/>	<input type="radio"/>	<input type="radio"/>	<input type="radio"/>	<input type="radio"/>	<input type="radio"/>	<input type="radio"/>	<input type="radio"/>	<input type="radio"/>	Disabled	<input checked="" type="checkbox"/>	16
11	<input type="radio"/>	<input type="radio"/>	<input type="radio"/>	<input type="radio"/>	<input type="radio"/>	<input type="radio"/>	<input type="radio"/>	<input type="radio"/>	<input type="radio"/>	<input type="radio"/>	<input type="radio"/>	<input type="radio"/>	<input type="radio"/>	<input type="radio"/>	<input type="radio"/>	<input type="radio"/>	<input type="radio"/>	<input type="radio"/>	<input type="radio"/>	<input type="radio"/>	<input type="radio"/>	<input type="radio"/>	<input type="radio"/>	<input type="radio"/>	<input type="radio"/>	<input type="radio"/>	<input type="radio"/>	<input type="radio"/>	<input type="radio"/>	<input type="radio"/>	<input type="radio"/>	Disabled	<input checked="" type="checkbox"/>	16
12	<input type="radio"/>	<input type="radio"/>	<input type="radio"/>	<input type="radio"/>	<input type="radio"/>	<input type="radio"/>	<input type="radio"/>	<input type="radio"/>	<input type="radio"/>	<input type="radio"/>	<input type="radio"/>	<input type="radio"/>	<input type="radio"/>	<input type="radio"/>	<input type="radio"/>	<input type="radio"/>	<input type="radio"/>	<input type="radio"/>	<input type="radio"/>	<input type="radio"/>	<input type="radio"/>	<input type="radio"/>	<input type="radio"/>	<input type="radio"/>	<input type="radio"/>	<input type="radio"/>	<input type="radio"/>	<input type="radio"/>	<input type="radio"/>	<input type="radio"/>	<input type="radio"/>	Disabled	<input checked="" type="checkbox"/>	16
13	<input type="radio"/>	<input type="radio"/>	<input type="radio"/>	<input type="radio"/>	<input type="radio"/>	<input type="radio"/>	<input type="radio"/>	<input type="radio"/>	<input type="radio"/>	<input type="radio"/>	<input type="radio"/>	<input type="radio"/>	<input type="radio"/>	<input type="radio"/>	<input type="radio"/>	<input type="radio"/>	<input type="radio"/>	<input type="radio"/>	<input type="radio"/>	<input type="radio"/>	<input type="radio"/>	<input type="radio"/>	<input type="radio"/>	<input type="radio"/>	<input type="radio"/>	<input type="radio"/>	<input type="radio"/>	<input type="radio"/>	<input type="radio"/>	<input type="radio"/>	<input type="radio"/>	Disabled	<input checked="" type="checkbox"/>	16
14	<input type="radio"/>	<input type="radio"/>	<input type="radio"/>	<input type="radio"/>	<input type="radio"/>	<input type="radio"/>	<input type="radio"/>	<input type="radio"/>	<input type="radio"/>	<input type="radio"/>	<input type="radio"/>	<input type="radio"/>	<input type="radio"/>	<input type="radio"/>	<input type="radio"/>	<input type="radio"/>	<input type="radio"/>	<input type="radio"/>	<input type="radio"/>	<input type="radio"/>	<input type="radio"/>	<input type="radio"/>	<input type="radio"/>	<input type="radio"/>	<input type="radio"/>	<input type="radio"/>	<input type="radio"/>	<input type="radio"/>	<input type="radio"/>	<input type="radio"/>	<input type="radio"/>	Disabled	<input checked="" type="checkbox"/>	16

Figure 4-3-2-3: Aggregation Group Configuration Page Screenshot

The page includes the following fields:

.Object	Description
<ul style="list-style-type: none"> <li><b>Group ID</b></li> </ul>	Indicates the group ID for the settings contained in the same row. Group ID "Normal" indicates there is no aggregation. Only one group ID is valid per port.
<ul style="list-style-type: none"> <li><b>Port Members</b></li> </ul>	Each switch port is listed for each group ID. Select a radio button to include a port in an aggregation, or clear the radio button to remove the port from the aggregation. By default, no ports belong to any aggregation group.
<ul style="list-style-type: none"> <li><b>Mode</b></li> </ul>	This parameter determines the mode for the aggregation group. <ul style="list-style-type: none"> <li>Disabled: The group is disabled.</li> <li>Static: The group operates in static aggregation mode.</li> <li>LACP (Active): The group operates in LACP active aggregation mode. See IEEE 801.AX-2014, section 6.4.1 for details.</li> <li>LACP (Passive): The group operates in LACP passive aggregation mode. See IEEE 801.AX-2014, section 6.4.1 for details.</li> </ul>
<ul style="list-style-type: none"> <li><b>Revertive</b></li> </ul>	This parameter only applies to LACP-enabled groups. It determines if the group will perform automatic link (re-)calculation when links with higher priority becomes available.
<ul style="list-style-type: none"> <li><b>Max Bundle</b></li> </ul>	This parameter only applies to LACP-enabled groups. It determines the maximum number of active bundled LACP ports allowed in an aggregation.

**Buttons**

: Click to apply changes

: Click to undo any changes made locally and revert to previously saved values.

### 4.3.2.2 Static Aggregation Status

This page is used to see the status of ports in Aggregation group. The Static Aggregation Status screen in [Figure 4-3-2-4](#) appears.

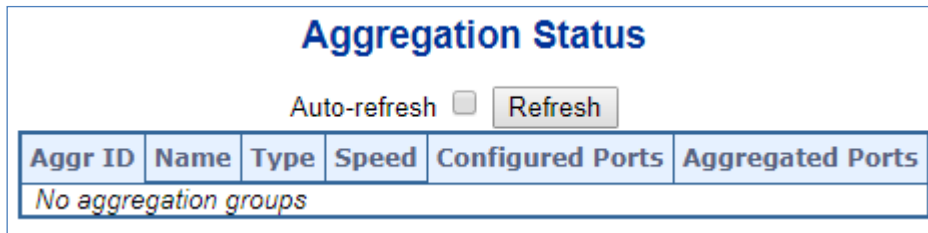

Figure 4-3-2-4 : LACP Port Configuration Page Screenshot

The page includes the following fields:

Object	Description
• <b>Aggr ID</b>	Display the Aggregation ID associated with this aggregation instance.
• <b>Name</b>	Display the Name of the Aggregation group ID.
• <b>Type</b>	Display the type of the Aggregation group(Static or LACP).
• <b>Speed</b>	Display the Speed of the Aggregation group.
• <b>Configured Ports</b>	Display the Configured member ports of the Aggregation group.
• <b>Aggregated Ports</b>	Display the Aggregated member ports of the Aggregation group.

#### Buttons

: Click to refresh the page immediately.

Auto-refresh : Automatic refresh occurs every 3 seconds.

### 4.3.2.3 LACP Configuration

Link Aggregation Control Protocol (LACP) - LACP LAG negotiate Aggregated Port links with other LACP ports located on a different device. LACP allows switches connected to each other to discover automatically whether any ports are member of the same LAG.

This page allows the user to inspect the current LACP port configurations, and possibly change them as well. The LACP Configuration screen in [Figure 4-3-2-5](#) appears.

### LACP System Configuration

System Priority

### LACP Port Configuration

Port	LACP	Timeout	Priority
*		<All> ▼	32768
1	No	Fast ▼	32768
2	No	Fast ▼	32768
3	No	Fast ▼	32768
4	No	Fast ▼	32768
5	No	Fast ▼	32768
6	No	Fast ▼	32768
7	No	Fast ▼	32768
8	No	Fast ▼	32768
9	No	Fast ▼	32768
10	No	Fast ▼	32768
11	No	Fast ▼	32768
12	No	Fast ▼	32768
13	No	Fast ▼	32768
14	No	Fast ▼	32768
15	No	Fast ▼	32768
16	No	Fast ▼	32768
17	No	Fast ▼	32768
18	No	Fast ▼	32768
19	No	Fast ▼	32768
20	No	Fast ▼	32768
21	No	Fast ▼	32768
22	No	Fast ▼	32768
23	No	Fast ▼	32768
24	No	Fast ▼	32768
25	No	Fast ▼	32768
26	No	Fast ▼	32768
27	No	Fast ▼	32768
28	No	Fast ▼	32768

Figure 4-3-2-5 : LACP Port Configuration Page Screenshot

The page includes the following fields:

Object	Description
<ul style="list-style-type: none"> <li>• <b>Port</b></li> </ul>	The switch port number.
<ul style="list-style-type: none"> <li>• <b>LACP Enabled</b></li> </ul>	Controls whether LACP is enabled on this switch port. LACP will form an aggregation when 2 or more ports are connected to the same partner.
<ul style="list-style-type: none"> <li>• <b>Timeout</b></li> </ul>	The Timeout controls the period between BPDU transmissions. Fast will transmit LACP packets each second, while Slow will wait for 30 seconds before sending a LACP packet.
<ul style="list-style-type: none"> <li>• <b>Priority</b></li> </ul>	The Priority controls the priority of the port. If the LACP partner wants to form a larger group than is supported by this device then this parameter will control which ports will be active and which ports will be in a backup role. Lower number means greater priority.

**Buttons**

 : Click to apply changes

 : Click to undo any changes made locally and revert to previously saved values.

**4.3.2.4 LACP System Status**

This page provides a status overview of all LACP instances. The LACP Status Page display the current LACP aggregation Groups and LACP Port status. The LACP System Status screen in [Figure 4-3-2-6](#) appears.

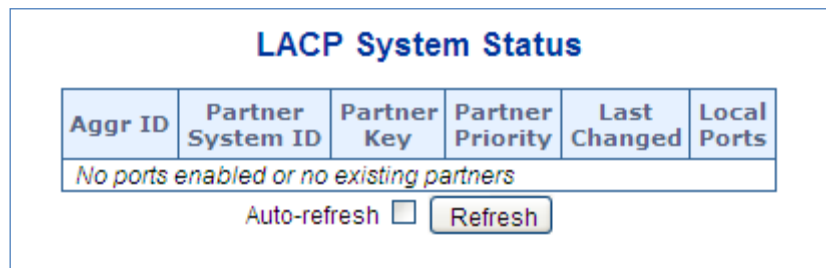

**Figure 4-3-2-6:** LACP System Status Page Screenshot

The page includes the following fields:

Object	Description
<ul style="list-style-type: none"> <li>• <b>Aggr ID</b></li> </ul>	The Aggregation ID associated with this aggregation instance. For LLAG the id is shown as 'isid:aggr-id' and for GLAGs as 'aggr-id'
<ul style="list-style-type: none"> <li>• <b>Partner System ID</b></li> </ul>	The system ID (MAC address) of the aggregation partner.
<ul style="list-style-type: none"> <li>• <b>Partner Key</b></li> </ul>	The Key that the partner has assigned to this aggregation ID.
<ul style="list-style-type: none"> <li>• <b>Partner Priority</b></li> </ul>	The priority of the aggregation partner.

• <b>Last Changed</b>	The time since this aggregation changed.
• <b>Local Ports</b>	Shows which ports are a part of this aggregation for this switch.

**Buttons**

: Click to refresh the page immediately.

Auto-refresh  Automatic refresh occurs every 3 seconds.

**4.3.2.5 LACP Internal Port Status**

This page provides a status overview of LACP status for all ports. The LACP Internal Port Status screen in [Figure 4-5-2-7](#) appears.

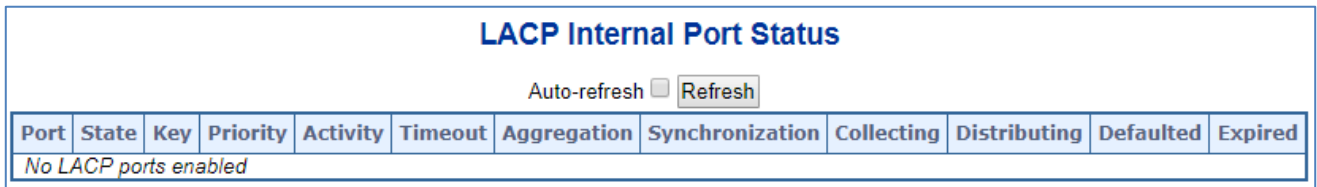

**Figure 4-3-2-7: LACP Status Page Screenshot**

The page includes the following fields:

Object	Description
• <b>Port</b>	The switch port number.
• <b>State</b>	The current port state: <ul style="list-style-type: none"> <li>● Down: The port is not active.</li> <li>● Active: The port is in active state.</li> <li>● Standby: The port is in standby state.</li> </ul>
• <b>Key</b>	The key assigned to this port. Only ports with the same key can aggregate together.
• <b>Priority</b>	The priority assigned to this aggregation group.
• <b>Activity</b>	The LACP mode of the group (Active or Passive).
• <b>Timeout</b>	The timeout mode configured for the port (Fast or Slow).
• <b>Aggregation</b>	Show whether the system considers this link to be "aggregateable"; i.e., a potential candidate for aggregation.
• <b>Synchronization</b>	Show whether the system considers this link to be "IN_SYNC"; i.e., it has been allocated to the correct LAG, the group has been associated with a compatible Aggregator, and the identity of the LAG is consistent with the System ID and

	operational Key information transmitted.
• <b>Collecting</b>	Show if collection of incoming frames on this link is enabled.
• <b>Distributing</b>	Show if distribution of outgoing frames on this link is enabled.
• <b>Defaulted</b>	Show if the Actor's Receive machine is using Defaulted operational Partner information.
• <b>Expired</b>	Show if that the Actor's Receive machine is in the EXPIRED state.

**Buttons**

: Click to refresh the page immediately.

Auto-refresh  Automatic refresh occurs every 3 seconds.

**4.3.2.6 LACP Neighbor Port Status**

This page provides a status overview of LACP status for all ports. The LACP Internal Port Status screen in [Figure 4-5-2-8](#) appears.



**Figure 4-3-2-8:** LACP Neighbor Port Status Page Screenshot

The page includes the following fields:

Object	Description
• <b>Port</b>	The switch port number.
• <b>State</b>	The current port state: <ul style="list-style-type: none"> <li>• Down: The port is not active.</li> <li>• Active: The port is in active state.</li> <li>• Standby: The port is in standby state.</li> </ul>
• <b>Aggr ID</b>	The aggregation group ID which the port is assigned to.
• <b>Partner Key</b>	The key assigned to this port by the partner.
• <b>Partner Priority</b>	The priority assigned to this partner port .
• <b>Activity</b>	The LACP mode of the group (Active or Passive).
• <b>Timeout</b>	The timeout mode configured for the port (Fast or Slow).
• <b>Aggregation</b>	Show whether the system considers this link to be "aggregateable"; i.e., a

	potential candidate for aggregation.
• <b>Synchronization</b>	Show whether the system considers this link to be "IN_SYNC"; i.e., it has been allocated to the correct LAG, the group has been associated with a compatible Aggregator, and the identity of the LAG is consistent with the System ID and operational Key information transmitted.
• <b>Collecting</b>	Show if collection of incoming frames on this link is enabled.
• <b>Distributing</b>	Show if distribution of outgoing frames on this link is enabled.
• <b>Defaulted</b>	Show if the Actor's Receive machine is using Defaulted operational Partner information.
• <b>Expired</b>	Show if that the Actor's Receive machine is in the EXPIRED state.

**Buttons**

: Click to refresh the page immediately.

Auto-refresh  Automatic refresh occurs every 3 seconds.

**4.3.2.7 LACP Port Statistics**

This page provides an overview of LACP statistics for all ports. The LACP Port Status screen in [Figure 4-5-2-9](#) appears.

Port	LACP Received	LACP Transmitted	Discarded	
			Unknown	Illegal
1	0	0	0	0
2	0	0	0	0
3	0	0	0	0
4	0	0	0	0
5	0	0	0	0
6	0	0	0	0
7	0	0	0	0
8	0	0	0	0
9	0	0	0	0
10	0	0	0	0
11	0	0	0	0
12	0	0	0	0

Auto-refresh

**Figure 4-3-2-9:** LACP Port Statistics Page Screenshot

The page includes the following fields:

Object	Description
• Port	The switch port number.
• LACP Received	Shows how many LACP frames have been received at each port.
• LACP Transmitted	Shows how many LACP frames have been sent from each port.
• Discarded	Shows how many unknown or illegal LACP frames have been discarded at each port.

### Buttons

: Click to refresh the page immediately.

Auto-refresh : Automatic refresh occurs every 3 seconds.

: Clears the counters for all ports.

## 4.3.3 VLAN

### 4.3.3.1 VLAN Overview

A **Virtual Local Area Network (VLAN)** is a network topology configured according to a logical scheme rather than the physical layout. VLAN can be used to combine any collection of LAN segments into an autonomous user group that appears as a single LAN. VLAN also logically segment the network into different broadcast domains so that packets are forwarded only between ports within the VLAN. Typically, a VLAN corresponds to a particular subnet, although not necessarily.

VLAN can enhance performance by conserving bandwidth, and improve security by limiting traffic to specific domains.

A VLAN is a collection of end nodes grouped by logic instead of physical location. End nodes that frequently communicate with each other are assigned to the same VLAN, regardless of where they are physically on the network. Logically, a VLAN can be equated to a broadcast domain, because broadcast packets are forwarded to only members of the VLAN on which the broadcast was initiated.



1. No matter what basis is used to uniquely identify end nodes and assign these nodes VLAN membership, packets cannot cross VLAN without a network device performing a routing function between the VLANs.
2. The **Industrial Managed Switch** supports IEEE 802.1Q VLAN. The port untagging function can be used to remove the 802.1 tag from packet headers to maintain compatibility with devices that are tag-unaware..



The **Industrial Managed Switch** 's default is to assign all ports to a single 802.1Q VLAN named DEFAULT\_VLAN. As new VLAN is created, the member ports assigned to the new VLAN will be removed from the DEFAULT\_VLAN port member list. The DEFAULT\_VLAN has a VID = 1.



This section has the following items:

- **VLAN Port Configuration** Enables VLAN group
- **VLAN Membership Status** Displays VLAN membership status
- **VLAN Port Status** Displays VLAN port status
- **Private VLAN** Creates/removes primary or community VLANs
- **Port Isolation** Enables/disables port isolation on port
- **MAC-based VLAN** Configures the MAC-based VLAN entries
- **MAC-based VLAN Status** Displays MAC-based VLAN entries
- **Protocol-based VLAN** Configures the protocol-based VLAN entries
- **Protocol-based VLAN Membership** Displays the protocol-based VLAN entries

#### 4.3.3.2 IEEE 802.1Q VLAN

In large networks, routers are used to isolate broadcast traffic for each subnet into separate domains. This **Industrial Managed Switch** provides a similar service at Layer 2 by using VLANs to organize any group of network nodes into separate broadcast domains. VLANs confine broadcast traffic to the originating group, and can eliminate broadcast storms in large networks. This also provides a more secure and cleaner network environment.

An IEEE 802.1Q VLAN is a group of ports that can be located anywhere in the network, but communicate as though they belong to the same physical segment.

VLANs help to simplify network management by allowing you to move devices to a new VLAN without having to change any physical connections. VLANs can be easily organized to reflect departmental groups (such as Marketing or R&D), usage groups (such as e-mail), or multicast groups (used for multimedia applications such as videoconferencing).

VLANs provide greater network efficiency by reducing broadcast traffic, and allow you to make network changes without having to update IP addresses or IP subnets. VLANs inherently provide a high level of network security since traffic must pass through a configured Layer 3 link to reach a different VLAN.

This **Industrial Managed Switch** supports the following VLAN features:

- Up to 255 VLANs based on the IEEE 802.1Q standard
- Port overlapping, allowing a port to participate in multiple VLANs
- End stations can belong to multiple VLANs
- Passing traffic between VLAN-aware and VLAN-unaware devices
- Priority tagging

#### ■ IEEE 802.1Q Standard

**IEEE 802.1Q (tagged) VLAN** is implemented on the Switch. 802.1Q VLAN requires tagging, which enables them to span the entire network (assuming all switches on the network are IEEE 802.1Q-compliant).

VLAN allows a network to be segmented in order to reduce the size of broadcast domains. All packets entering a VLAN will only be forwarded to the stations (over IEEE 802.1Q enabled switches) that are members of that VLAN, and this includes broadcast, multicast and unicast packets from unknown sources.

VLAN can also provide a level of security to your network. IEEE 802.1Q VLAN will only deliver packets between stations that are members of the VLAN. Any port can be configured as either **tagging** or **untagging**.

- The untagging feature of IEEE 802.1Q VLAN allows VLAN to work with legacy switches that don't recognize VLAN tags in packet headers.
- The tagging feature allows VLAN to span multiple 802.1Q-compliant switches through a single physical connection and allows Spanning Tree to be enabled on all ports and work normally.

Some relevant terms:

- **Tagging** - The act of putting 802.1Q VLAN information into the header of a packet.
- **Untagging** - The act of stripping 802.1Q VLAN information out of the packet header.

### 802.1Q VLAN Tags

The figure below shows the 802.1Q VLAN tag. There are four additional octets inserted after the source MAC address. Their presence is indicated by a value of **0x8100** in the Ether Type field. When a packet's Ether Type field is equal to 0x8100, the packet carries the IEEE 802.1Q/802.1p tag. The tag is contained in the following two octets and consists of 3 bits of user priority, 1 bit of Canonical Format Identifier (CFI - used for encapsulating Token Ring packets so they can be carried across Ethernet backbones), and 12 bits of **VLAN ID (VID)**. The 3 bits of user priority are used by 802.1p. The VID is the VLAN identifier and is used by the 802.1Q standard. Because the VID is 12 bits long, 4094 unique VLAN can be identified.

The tag is inserted into the packet header making the entire packet longer by 4 octets. All of the information originally contained in the packet is retained.

#### 802.1Q Tag

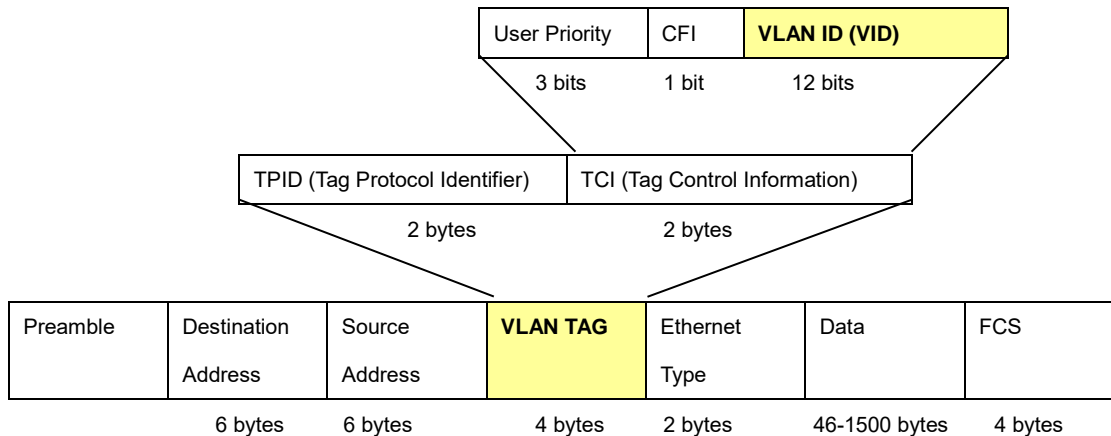

The Ether Type and VLAN ID are inserted after the MAC source address, but before the original Ether Type/Length or Logical Link Control. Because the packet is now a bit longer than it was originally, the Cyclic Redundancy Check (CRC) must be recalculated.

### Adding an IEEE802.1Q Tag

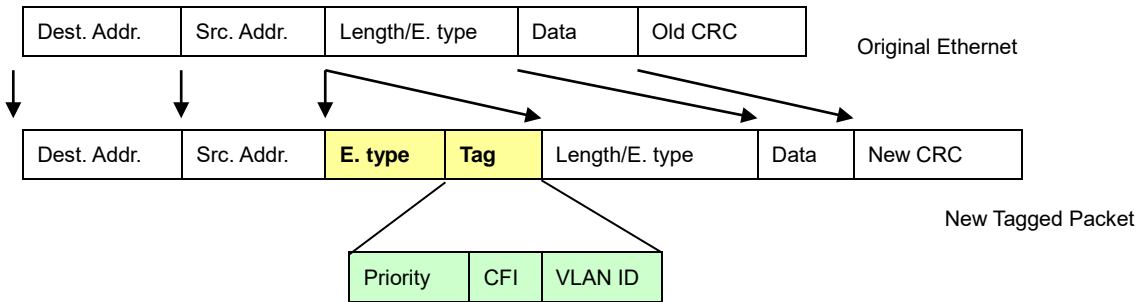

### Port VLAN ID

Packets that are tagged (are carrying the 802.1Q VID information) can be transmitted from one 802.1Q compliant network device to another with the VLAN information intact. This allows 802.1Q VLAN to span network devices (and indeed, the entire network – if all network devices are 802.1Q compliant).

Every physical port on a switch has a PVID. 802.1Q ports are also assigned a PVID, for use within the switch. If no VLAN are defined on the switch, all ports are then assigned to a default VLAN with a PVID equal to 1. Untagged packets are assigned the PVID of the port on which they were received. Forwarding decisions are based upon this PVID, in so far as VLAN are concerned. Tagged packets are forwarded according to the VID contained within the tag. Tagged packets are also assigned a PVID, but the PVID is not used to make packet forwarding decisions, the VID is.

Tag-aware switches must keep a table to relate PVID within the switch to VID on the network. The switch will compare the VID of a packet to be transmitted to the VID of the port that is to transmit the packet. If the two VID are different the switch will drop the packet. Because of the existence of the PVID for untagged packets and the VID for tagged packets, tag-aware and tag-unaware network devices can coexist on the same network.

A switch port can have only one PVID, but can have as many VID as the switch has memory in its VLAN table to store them.

Because some devices on a network may be tag-unaware, a decision must be made at each port on a tag-aware device before packets are transmitted – should the packet to be transmitted have a tag or not? If the transmitting port is connected to a tag-unaware device, the packet should be untagged. If the transmitting port is connected to a tag-aware device, the packet should be tagged.

### Default VLANs

The Switch initially configures one VLAN, VID = 1, called "**default**." The factory default setting assigns all ports on the Switch to the "**default**". As new VLAN are configured in Port-based mode, their respective member ports are removed from the "**default**".

### Assigning Ports to VLANs

Before enabling VLANs for the switch, you must first assign each port to the VLAN group(s) in which it will participate. By default all ports are assigned to VLAN 1 as untagged ports. Add a port as a tagged port if you want it to carry traffic for one or more VLANs, and any intermediate network devices or the host at the other end of the connection supports VLANs. Then assign ports on the other VLAN-aware network devices along the path that will carry this traffic to the same VLAN(s), either manually or dynamically using GVRP. However, if you want a port on this switch to participate in one or more VLANs, but none of the

intermediate network devices nor the host at the other end of the connection supports VLANs, then you should add this port to the VLAN as an untagged port.



---

VLAN-tagged frames can pass through VLAN-aware or VLAN-unaware network interconnection devices, but the VLAN tags should be stripped off before passing it on to any end-node host that does not support VLAN tagging.

---

## ■ VLAN Classification

When the switch receives a frame, it classifies the frame in one of two ways. If the frame is untagged, the switch assigns the frame to an associated VLAN (based on the default VLAN ID of the receiving port). But if the frame is tagged, the switch uses the tagged VLAN ID to identify the port broadcast domain of the frame.

## ■ Port Overlapping

Port overlapping can be used to allow access to commonly shared network resources among different VLAN groups, such as file servers or printers. Note that if you implement VLANs which do not overlap, but still need to communicate, you can connect them by enabled routing on this switch.

## ■ Untagged VLANs

Untagged (or static) VLANs are typically used to reduce broadcast traffic and to increase security. A group of network users assigned to a VLAN form a broadcast domain that is separate from other VLANs configured on the switch. Packets are forwarded only between ports that are designated for the same VLAN. Untagged VLANs can be used to manually isolate user groups or subnets.

### 4.3.3.3 VLAN Port Configuration

This page is used for configuring the **Industrial Managed Switch** port VLAN. The VLAN per Port Configuration page contains fields for managing ports that are part of a VLAN. The port default VLAN ID (PVID) is configured on the VLAN Port Configuration page. All untagged packets arriving to the device are tagged by the ports PVID.

## Understanding nomenclature of the Switch

### ■ IEEE 802.1Q Tagged and Untagged

Every port on an 802.1Q compliant switch can be configured as tagged or untagged.

- **Tagged:** Ports with tagging enabled will put the VID number, priority and other VLAN information into the header of all packets that flow into those ports. If a packet has previously been tagged, the port will not alter the packet, thus keeping the VLAN information intact. The VLAN information in the tag can then be used by other 802.1Q compliant devices on the network to make packet-forwarding decisions.
- **Untagged:** Ports with untagging enabled will strip the 802.1Q tag from all packets that flow into those

ports. If the packet doesn't have an 802.1Q VLAN tag, the port will not alter the packet. Thus, all packets received by and forwarded by an untagging port will have no 802.1Q VLAN information. (Remember that the PVID is only used internally within the Switch). Untagging is used to send packets from an 802.1Q-compliant network device to a non-compliant network device.

Frame Income \ Frame Leave	Income Frame is <b>tagged</b>	Income Frame is <b>untagged</b>
Leave port is tagged	Frame remains tagged	Tag is inserted
Leave port is untagged	Tag is removed	Frame remain untagged

**Table 4-3-3-1:** Ingress / Egress Port with VLAN VID Tag / Untag Table

### ■ IEEE 802.1Q Tunneling (Q-in-Q)

IEEE 802.1Q Tunneling (Q-in-Q) is designed for service providers carrying traffic for multiple customers across their networks. Q-in-Q tunneling is used to maintain customer-specific VLAN and Layer 2 protocol configurations even when different customers use the same internal VLAN IDs. This is accomplished by inserting **Service Provider VLAN (SPVLAN)** tags into the customer's frames when they enter the service provider's network, and then stripping the tags when the frames leave the network.

A service provider's customers may have specific requirements for their internal VLAN IDs and number of VLANs supported. VLAN ranges required by different customers in the same service-provider network might easily overlap, and traffic passing through the infrastructure might be mixed. Assigning a unique range of VLAN IDs to each customer would restrict customer configurations, require intensive processing of VLAN mapping tables, and could easily exceed the maximum VLAN limit of 4096.

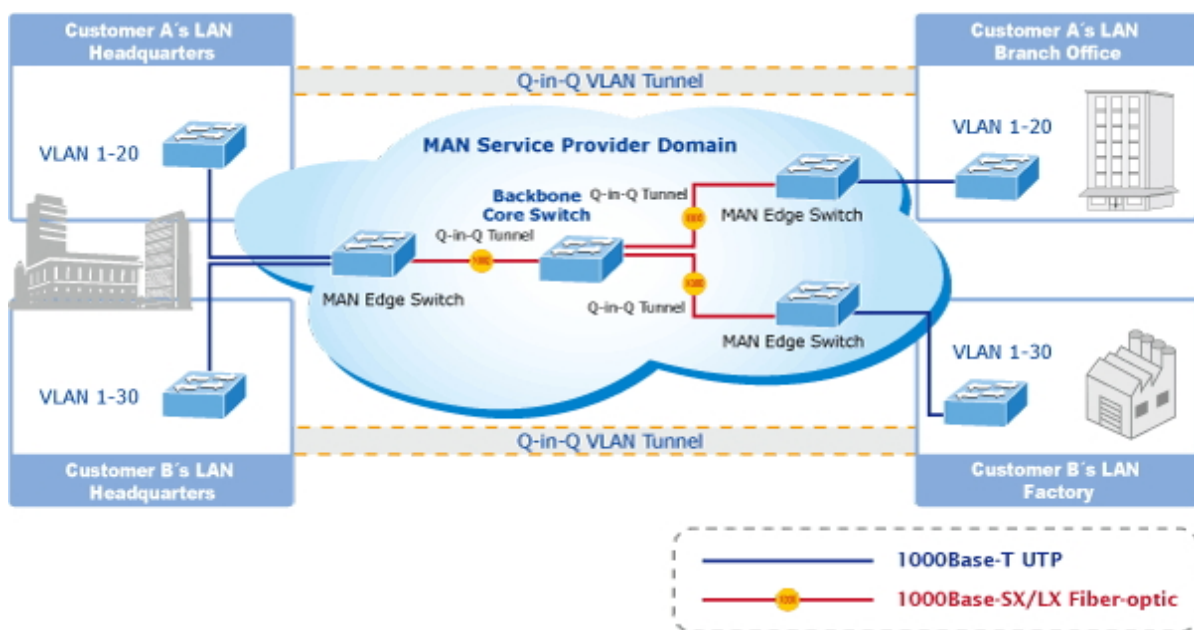

The **Industrial Managed Switch** supports multiple VLAN tags and can therefore be used in MAN applications as a provider bridge, aggregating traffic from numerous independent customer LANs into the **MAN (Metro Access Network)** space. One of

the purposes of the provider bridge is to recognize and use VLAN tags so that the VLANs in the MAN space can be used independent of the customers' VLANs. This is accomplished by adding a VLAN tag with a MAN-related VID for frames entering the MAN. When leaving the MAN, the tag is stripped and the original VLAN tag with the customer-related VID is again available.

This provides a tunneling mechanism to connect remote customer VLANs through a common MAN space without interfering with the VLAN tags. All tags use EtherType **0x8100** or **0x88A8**, where 0x8100 is used for customer tags and 0x88A8 are used for service provider tags.

In cases where a given service VLAN only has two member ports on the switch, the learning can be disabled for the particular VLAN and can therefore rely on flooding as the forwarding mechanism between the two ports. This way, the MAC table requirements is reduced.

### Global VLAN Configuration

The Global VLAN Configuration screen in [Figure 4-3-3-1](#) appears.

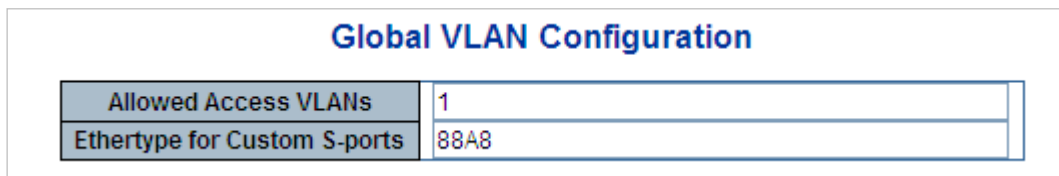

Figure 4-3-3-1 : Global VLAN Configuration Screenshot

The page includes the following fields:

Object	Description
<ul style="list-style-type: none"> <li><b>Allowed Access VLANs</b></li> </ul>	<p>This field shows the allowed Access VLANs, it only affects ports configured as Access ports. Ports in other modes are members of all VLANs specified in the Allowed VLANs field.</p> <p>By default, only VLAN 1 is enabled. More VLANs may be created by using a list syntax where the individual elements are separated by commas. Ranges are specified with a dash separating the lower and upper bound.</p> <p>The following example will create VLANs 1, 10, 11, 12, 13, 200, and 300:  <code>1,10-13,200,300</code>. Spaces are allowed in between the delimiters.</p>
<ul style="list-style-type: none"> <li><b>Ethertype for Custom S-ports</b></li> </ul>	<p>This field specifies the ethertype/TPID (specified in hexadecimal) used for Custom S-ports. The setting is in force for all ports whose Port Type is set to S-Custom-Port.</p>

### Port VLAN Configuration

The VLAN Port Configuration screen in [Figure 4-3-3-2](#) appears.

Port	Mode	Port VLAN	Port Type	Ingress Filtering	Ingress Acceptance	Egress Tagging	Allowed VLANs	Forbidden VLANs
*	<All>	1	<All>	<input type="checkbox"/>	<All>	<All>	1	
1	Access	1	C-Port	<input checked="" type="checkbox"/>	Tagged and Untagged	Untag Port VLAN	1	
2	Access	1	C-Port	<input checked="" type="checkbox"/>	Tagged and Untagged	Untag Port VLAN	1	
3	Access	1	C-Port	<input checked="" type="checkbox"/>	Tagged and Untagged	Untag Port VLAN	1	
4	Access	1	C-Port	<input checked="" type="checkbox"/>	Tagged and Untagged	Untag Port VLAN	1	
5	Access	1	C-Port	<input checked="" type="checkbox"/>	Tagged and Untagged	Untag Port VLAN	1	
6	Access	1	C-Port	<input checked="" type="checkbox"/>	Tagged and Untagged	Untag Port VLAN	1	
7	Access	1	C-Port	<input checked="" type="checkbox"/>	Tagged and Untagged	Untag Port VLAN	1	
8	Access	1	C-Port	<input checked="" type="checkbox"/>	Tagged and Untagged	Untag Port VLAN	1	

**Figure 4-3-2 : Port VLAN Configuration Screenshot**

The page includes the following fields:

Object	Description
<ul style="list-style-type: none"> <li>Port</li> </ul>	This is the logical port number for this row.
<ul style="list-style-type: none"> <li>Mode</li> </ul>	<p><b>Access</b></p> <p>Access ports are normally used to connect to end stations. Dynamic features like Voice VLAN may add the port to more VLANs behind the scenes. Access ports have the following characteristics:</p> <ul style="list-style-type: none"> <li>Member of exactly one VLAN, the Port VLAN (Access VLAN), which by default is 1</li> <li>Accepts untagged and C-tagged frames</li> <li>Discards all frames that are not classified to the Access VLAN</li> <li>On egress all frames classified to the Access VLAN are transmitted untagged. Other (dynamically added VLANs) are transmitted tagged</li> </ul>
	<p><b>Trunk</b></p> <p>Trunk ports can carry traffic on multiple VLANs simultaneously, and are normally used to connect to other switches. Trunk ports have the following characteristics:</p> <ul style="list-style-type: none"> <li>By default, a trunk port is member of all VLANs (1-4095)</li> <li>The VLANs that a trunk port is member of may be limited by the use of Allowed VLANs</li> <li>Frames classified to a VLAN that the port is not a member of are discarded</li> <li>By default, all frames but frames classified to the Port VLAN (a.k.a. Native VLAN) get tagged on egress. Frames classified to the Port VLAN do not get C-tagged on egress</li> <li>Egress tagging can be changed to tag all frames, in which case only tagged frames are accepted on ingress</li> </ul>
	<p><b>Hybrid</b></p> <p>Hybrid ports resemble trunk ports in many ways, but adds additional port configuration features. In addition to the characteristics described for trunk ports,</p>

	<p>hybrid ports have these abilities:</p> <ul style="list-style-type: none"> <li>• Can be configured to be VLAN tag unaware, C-tag aware, S-tag aware, or S-custom-tag aware</li> <li>• Ingress filtering can be controlled</li> <li>• Ingress acceptance of frames and configuration of egress tagging can be configured independently</li> </ul>
<ul style="list-style-type: none"> <li>• <b>Port VLAN</b></li> </ul>	<p>Determines the <b>port's VLAN ID (PVID)</b>. Allowed VLANs are in the range 1 through 4095, default being 1.</p> <ul style="list-style-type: none"> <li>■ On ingress, frames get classified to the Port VLAN if the port is configured as VLAN unaware, the frame is untagged, or VLAN awareness is enabled on the port, but the frame is priority tagged (VLAN ID = 0).</li> <li>■ On egress, frames classified to the Port VLAN do not get tagged if Egress Tagging configuration is set to untag Port VLAN.</li> </ul> <p>The Port VLAN is called an "<b>Access VLAN</b>" for ports in Access mode and Native VLAN for ports in Trunk or Hybrid mode.</p>
<ul style="list-style-type: none"> <li>• <b>Port Type</b></li> </ul>	<p>Ports in hybrid mode allow for changing the port type, that is, whether a frame's VLAN tag is used to classify the frame on ingress to a particular VLAN, and if so, which TPID it reacts on. Likewise, on egress, the Port Type determines the TPID of the tag, if a tag is required.</p> <ul style="list-style-type: none"> <li>■ <b><u>Unaware:</u></b> On ingress, all frames, whether carrying a VLAN tag or not, get classified to the Port VLAN, and possible tags are not removed on egress.</li> <li>■ <b><u>C-Port:</u></b> On ingress, frames with a VLAN tag with TPID = 0x8100 get classified to the VLAN ID embedded in the tag. If a frame is untagged or priority tagged, the frame gets classified to the Port VLAN. If frames must be tagged on egress, they will be tagged with a C-tag.</li> <li>■ <b><u>S-Port:</u></b> On ingress, frames with a VLAN tag with TPID = 0x8100 or 0x88A8 get classified to the VLAN ID embedded in the tag. If a frame is untagged or priority tagged, the frame gets classified to the Port VLAN. If frames must be tagged on egress, they will be tagged with an S-tag.</li> <li>■ <b><u>S-Custom-Port:</u></b> On ingress, frames with a VLAN tag with a TPID = 0x8100 or equal to the Ethertype configured for Custom-S ports get classified to the VLAN ID embedded in the tag. If a frame is untagged or priority tagged, the frame gets classified to the Port VLAN. If frames must be tagged on egress, they will be tagged with the custom S-tag.</li> </ul>
<ul style="list-style-type: none"> <li>• <b>Ingress Filtering</b></li> </ul>	<p>Hybrid ports allow for changing ingress filtering. Access and Trunk ports always have ingress filtering enabled.</p>



	<ul style="list-style-type: none"> <li>■ If ingress filtering is enabled (checkbox is checked), frames classified to a VLAN that the port is not a member of get discarded.</li> <li>■ If ingress filtering is disabled, frames classified to a VLAN that the port is not a member of are accepted and forwarded to the switch engine.</li> </ul> <p>However, the port will never transmit frames classified to VLANs that it is not a member of.</p>
<ul style="list-style-type: none"> <li>• <b>Ingress Acceptance</b></li> </ul>	<p>Hybrid ports allow for changing the type of frames that are accepted on ingress.</p> <ul style="list-style-type: none"> <li>■ <b><u>Tagged and Untagged</u></b> Both tagged and untagged frames are accepted.</li> <li>■ <b><u>Tagged Only</u></b> Only tagged frames are accepted on ingress. Untagged frames are discarded.</li> <li>■ <b><u>Untagged Only</u></b> Only untagged frames are accepted on ingress. Tagged frames are discarded.</li> </ul>
<p><b>Egress Tagging</b></p>	<p>This option is only available for ports in Hybrid mode. Ports in Trunk and Hybrid mode may control the tagging of frames on egress.</p> <ul style="list-style-type: none"> <li>■ <b><u>Untag Port VLAN</u></b> Frames classified to the Port VLAN are transmitted untagged. Other frames are transmitted with the relevant tag.</li> <li>■ <b><u>Tag All</u></b> All frames, whether classified to the Port VLAN or not, are transmitted with a tag.</li> <li>■ <b><u>Untag All</u></b> All frames, whether classified to the Port VLAN or not, are transmitted without a tag.</li> </ul>
<ul style="list-style-type: none"> <li>• <b>Allowed VLANs</b></li> </ul>	<p>Ports in Trunk and Hybrid mode may control which VLANs they are allowed to become members of. The field's syntax is identical to the syntax used in the Enabled VLANs field.</p> <p>By default, a Trunk or Hybrid port will become member of all VLANs, and is therefore set to <b>1-4095</b>. The field may be left empty, which means that the port will not become member of any VLANs.</p>
<ul style="list-style-type: none"> <li>• <b>Forbidden VLANs</b></li> </ul>	<p>A port may be configured to never be member of one or more VLANs. This is particularly useful when dynamic VLAN protocols like MVRP and GVRP must be prevented from dynamically adding ports to VLANs. The trick is to mark such VLANs as forbidden on the port in question. The syntax is identical to the syntax used in the Enabled VLANs field.</p> <p>By default, the field is left blank, which means that the port may become a member of all possible VLANs.</p>



The port must be a member of the same VLAN as the Port VLAN ID.

**Buttons**

**Apply** : Click to apply changes

**Reset** : Click to undo any changes made locally and revert to previously saved values.

**4.3.3.4 VLAN Membership Status**

This page provides an overview of membership status for VLAN users. The VLAN Membership Status screen in [Figure 4-3-3-3](#) appears.

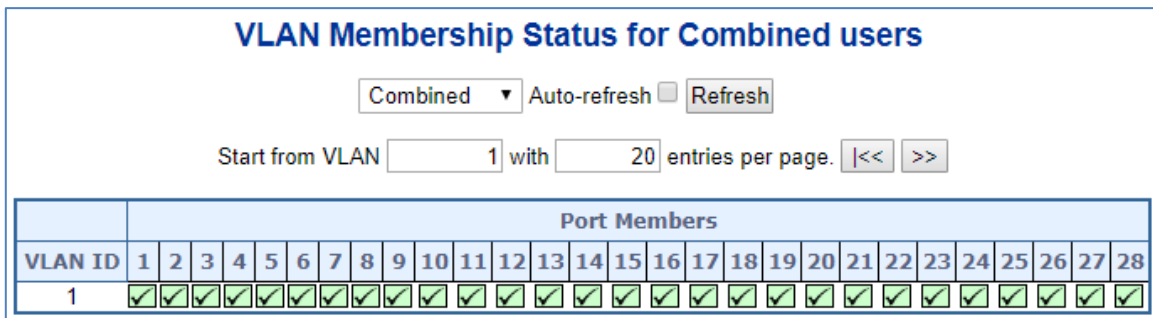

**Figure 4-3-3-3:** VLAN Membership Status for Static User Page Screenshot

The page includes the following fields:

Object	Description
<ul style="list-style-type: none"> <li><b>VLAN User</b></li> </ul>	<p>A VLAN User is a module that uses services of the VLAN management functionality to configure VLAN memberships and VLAN port configuration such as PVID, UVID. Currently we support following VLAN :</p> <ul style="list-style-type: none"> <li>- <b>Admin</b> : This is referred as static.</li> <li>- <b>NAS</b> : NAS provides port-based authentication, which involves communications between a Supplicant, Authenticator, and an Authentication Server.</li> <li>- <b>GVRP</b> : GVRP (GARP VLAN Registration Protocol or Generic VLAN Registration Protocol) is a protocol that facilitates control of virtual local area networks (VLANs) within a larger network .</li> <li>- <b>Voice VLAN</b> : Voice VLAN is a VLAN configured specially for voice traffic typically originating from IP phones.</li> <li>- <b>MVR</b> : MVR is used to eliminate the need to duplicate multicast traffic for subscribers in each VLAN. Multicast traffic for all channels is sent only on a</li> </ul>

	single (multicast) VLAN.
<ul style="list-style-type: none"> <li>• <b>Port Members</b></li> </ul>	<p>A row of check boxes for each port is displayed for each VLAN ID.</p> <p>If a port is included in a VLAN, an image <input checked="" type="checkbox"/> will be displayed.</p> <p>If a port is included in a Forbidden port list, an image <input type="checkbox"/> will be displayed.</p> <p>If a port is included in a Forbidden port list and dynamic VLAN user register VLAN on same Forbidden port, then conflict port will be displayed as conflict port.</p>
<ul style="list-style-type: none"> <li>• <b>VLAN Membership</b></li> </ul>	<p>The VLAN Membership Status page shall show the current VLAN port members for all VLANs configured by a selected VLAN User (selection shall be allowed by a Combo Box). When ALL VLAN Users are selected, it shall show this information for all the VLAN Users, and this is by default. VLAN membership allows the frames classified to the VLAN ID to be forwarded on the respective VLAN member ports.</p>

**Buttons**

: Select VLAN Users from this drop down list.

Auto-refresh : Check this box to refresh the page automatically. Automatic refresh occurs every 3 seconds.

: Click to refresh the page immediately.

: Updates the table starting from the first entry in the VLAN Table, i.e. the entry with the lowest VLAN ID.

: Updates the table, starting with the entry after the last entry currently displayed.

**4.3.3.5 VLAN Port Status**

This page provides VLAN Port Status. The VLAN Port Status screen in [Figure 4-3-3-4](#) appears.

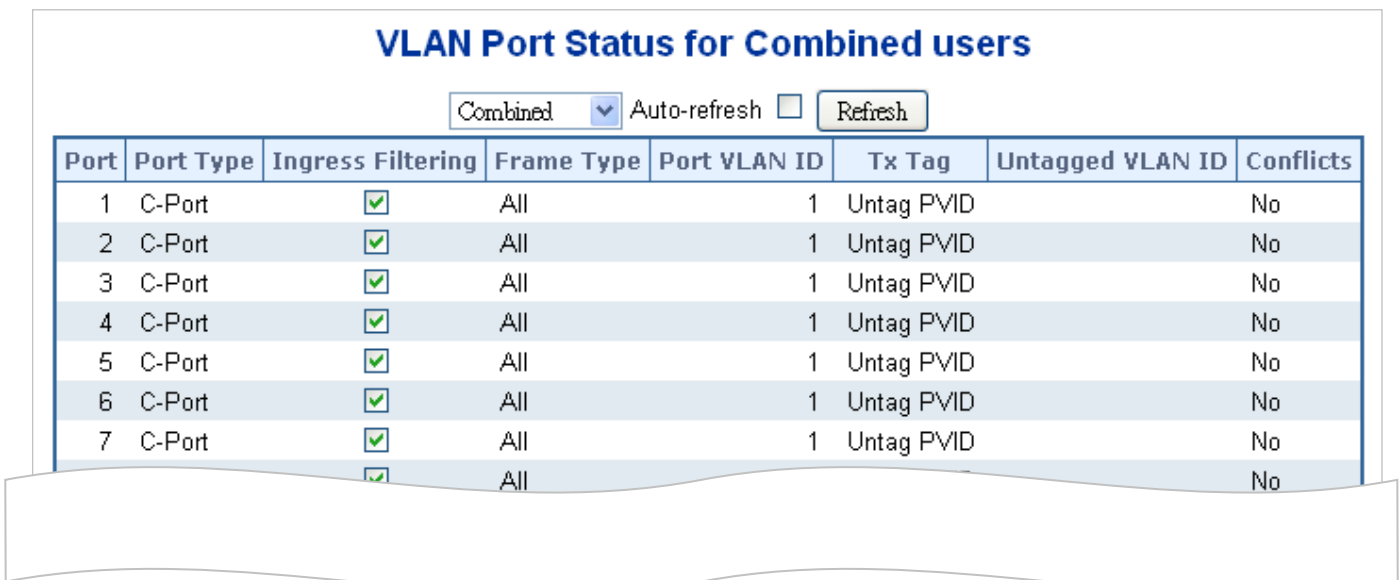

Port	Port Type	Ingress Filtering	Frame Type	Port VLAN ID	Tx Tag	Untagged VLAN ID	Conflicts
1	C-Port	<input checked="" type="checkbox"/>	All	1	Untag PVID		No
2	C-Port	<input checked="" type="checkbox"/>	All	1	Untag PVID		No
3	C-Port	<input checked="" type="checkbox"/>	All	1	Untag PVID		No
4	C-Port	<input checked="" type="checkbox"/>	All	1	Untag PVID		No
5	C-Port	<input checked="" type="checkbox"/>	All	1	Untag PVID		No
6	C-Port	<input checked="" type="checkbox"/>	All	1	Untag PVID		No
7	C-Port	<input checked="" type="checkbox"/>	All	1	Untag PVID		No
		<input checked="" type="checkbox"/>	All				No

**Figure 4-3-3-4:** VLAN Port Status for Combined users Page Screenshot

The page includes the following fields:

Object	Description
<ul style="list-style-type: none"> <li>• <b>Port</b></li> </ul>	The logical port for the settings contained in the same row.
<ul style="list-style-type: none"> <li>• <b>Port Type</b></li> </ul>	<p>Show the VLAN Awareness for the port.</p> <p>If VLAN awareness is enabled, the tag is removed from tagged frames received on the port. VLAN tagged frames are classified to the VLAN ID in the tag.</p> <p>If VLAN awareness is disabled, all frames are classified to the Port VLAN ID and tags are not removed.</p>
<ul style="list-style-type: none"> <li>• <b>Ingress Filtering</b></li> </ul>	Show the ingress filtering for a port. This parameter affects VLAN ingress processing. If ingress filtering is enabled and the ingress port is not a member of the classified VLAN of the frame, the frame is discarded.

<ul style="list-style-type: none"> <li>• <b>Frame Type</b></li> </ul>	Shows whether the port accepts all frames or only tagged frames. This parameter affects VLAN ingress processing. If the port only accepts tagged frames, untagged frames received on that port are discarded.
<ul style="list-style-type: none"> <li>• <b>Port VLAN ID</b></li> </ul>	Shows the PVID setting for the port.
<ul style="list-style-type: none"> <li>• <b>Tx Tag</b></li> </ul>	Shows egress filtering frame status whether tagged or untagged.
<ul style="list-style-type: none"> <li>• <b>Untagged VLAN ID</b></li> </ul>	Shows UVID (untagged VLAN ID). Port's UVID determines the packet's behavior at the egress side.
<ul style="list-style-type: none"> <li>• <b>Conflicts</b></li> </ul>	Shows status of Conflicts whether exists or Not. When a Volatile VLAN User requests to set VLAN membership or VLAN port configuration, the following conflicts can occur: <ul style="list-style-type: none"> <li>■ Functional Conflicts between feature.</li> <li>■ Conflicts due to hardware limitation.</li> <li>■ Direct conflict between user modules.</li> </ul>

**Buttons**

: Select VLAN Users from this drop down list.

Auto-refresh  Check this box to refresh the page automatically. Automatic refresh occurs every 3 seconds.

: Click to refresh the page immediately.

**4.3.3.6 Private VLAN**

The Private VLAN membership configurations for the switch can be monitored and modified here. Private VLANs can be added or deleted here. Port members of each Private VLAN can be added or removed here.

Private VLANs are based on the source port mask, and there are no connections to VLANs. This means that VLAN IDs and Private VLAN IDs can be identical.

A port must be a member of both a VLAN and a Private VLAN to be able to forward packets. By default, all ports are VLAN unaware and members of VLAN 1 and Private VLAN 1.

A VLAN unaware port can only be a member of one VLAN, but it can be a member of multiple Private VLANs. The VLAN Port Status screen in [Figure 4-3-3-5](#) appears.

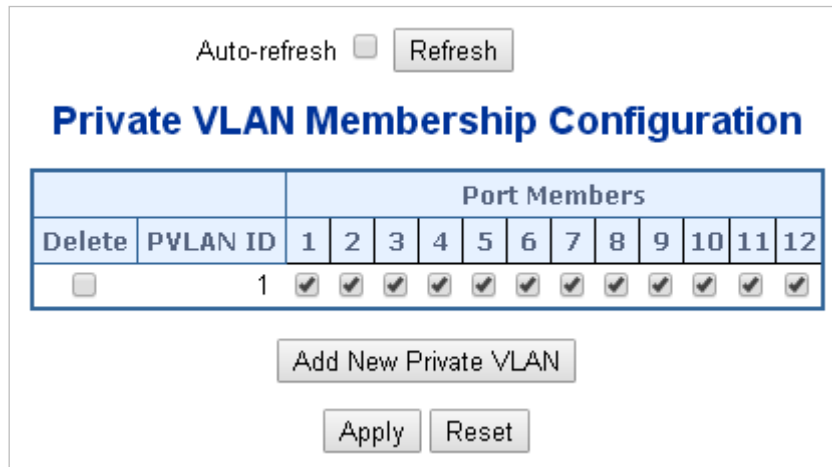

Figure 4-3-3-5: Private VLAN Membership Configuration page screenshot

The page includes the following fields:

Object	Description
<ul style="list-style-type: none"> <li>• <b>Delete</b></li> </ul>	To delete a private VLAN entry, check this box. The entry will be deleted during the next save.
<ul style="list-style-type: none"> <li>• <b>Private VLAN ID</b></li> </ul>	Indicates the ID of this particular private VLAN.
<ul style="list-style-type: none"> <li>• <b>Port Members</b></li> </ul>	A row of check boxes for each port is displayed for each private VLAN ID. To include a port in a Private VLAN, check the box. To remove or exclude the port from the Private VLAN, make sure the box is unchecked. By default, no ports are members, and all boxes are unchecked.
<ul style="list-style-type: none"> <li>• <b>Adding a New Private VLAN</b></li> </ul>	Click "Add New Private VLAN" to add a new private VLAN ID. An empty row is added to the table, and the private VLAN can be configured as needed. The allowed range for a private VLAN ID is the same as the switch port number range. Any values outside this range are not accepted, and a warning message appears. Click "OK" to discard the incorrect entry, or click "Cancel" to return to the editing and make a correction.  The Private VLAN is enabled when you click "Save".  The "Delete" button can be used to undo the addition of new Private VLANs.

**Buttons**

: Click to add new VLAN.

: Click to save changes.

: Click to undo any changes made locally and revert to previously saved values.

Auto-refresh : Check this box to refresh the page automatically. Automatic refresh occurs every 3 seconds.

: Click to refresh the page immediately.

### 4.3.3.7 Port Isolation

#### Overview

When a VLAN is configured to be a private VLAN, communication between ports within that VLAN can be prevented. Two application examples are provided in this section:

- Customers connected to an ISP can be members of the same VLAN, but they are not allowed to communicate with each other within that VLAN.
- Servers in a farm of web servers in a Demilitarized Zone (DMZ) are allowed to communicate with the outside world and with database servers on the inside segment, but are not allowed to communicate with each other

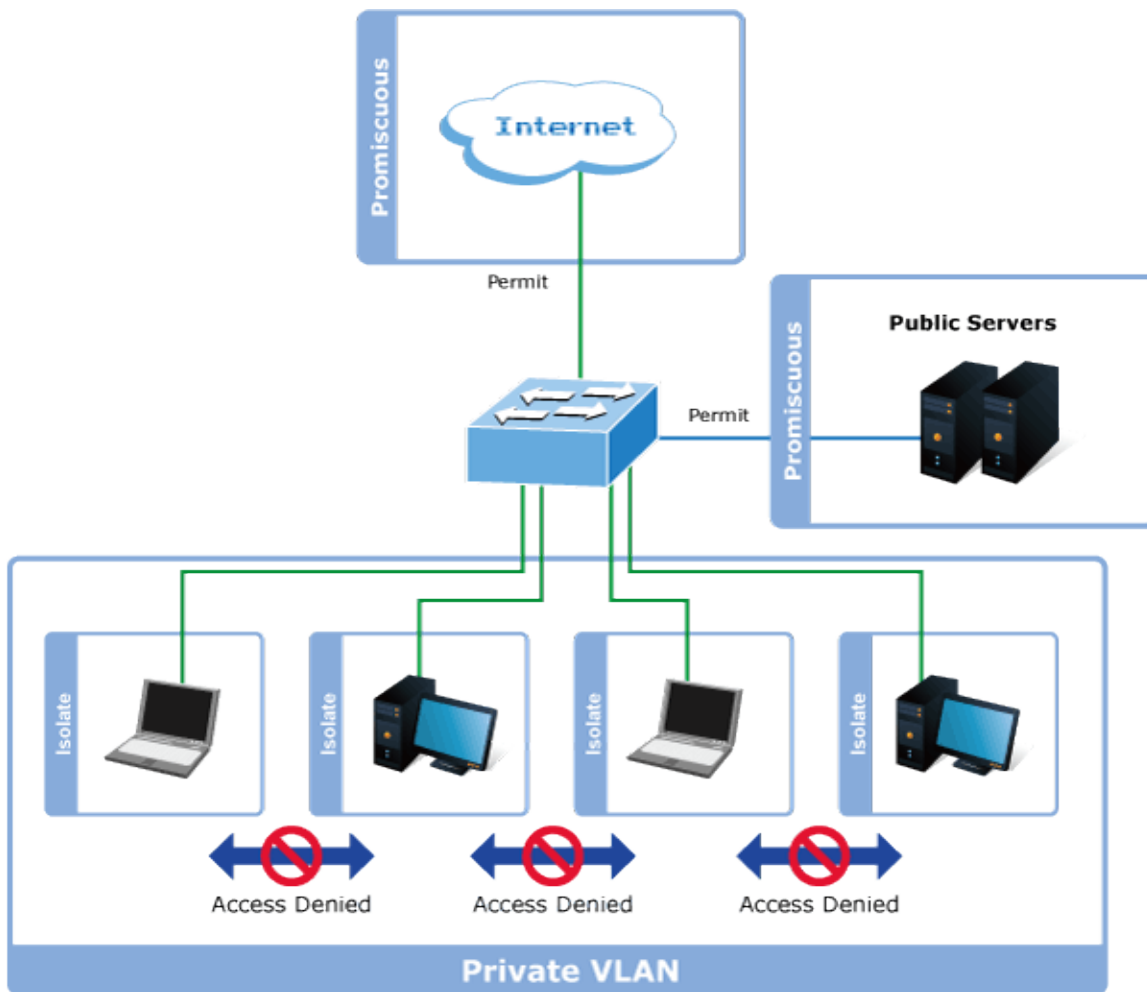

For private VLANs to be applied, the switch must first be configured for standard VLAN operation. When this is in place, one or more of the configured VLANs can be configured as private VLANs. Ports in a private VLAN fall into one of these two groups:

■ **Promiscuous ports**

- Ports from which traffic can be forwarded to all ports in the private VLAN
- Ports which can receive traffic from all ports in the private VLAN

■ **Isolated ports**

- Ports from which traffic can only be forwarded to promiscuous ports in the private VLAN
- Ports which can receive traffic from only promiscuous ports in the private VLAN

The configuration of promiscuous and isolated ports applies to all private VLANs. When traffic comes in on a promiscuous port

in a private VLAN, the VLAN mask from the VLAN table is applied. When traffic comes in on an isolated port, the private VLAN mask is applied in addition to the VLAN mask from the VLAN table. This reduces the ports to which forwarding can be done to just the promiscuous ports within the private VLAN.

This page is used for enabling or disabling port isolation on ports in a Private VLAN. A port member of a VLAN can be isolated to other isolated ports on the same VLAN and Private VLAN. The Port Isolation screen in [Figure 4-3-3-6](#) appears.

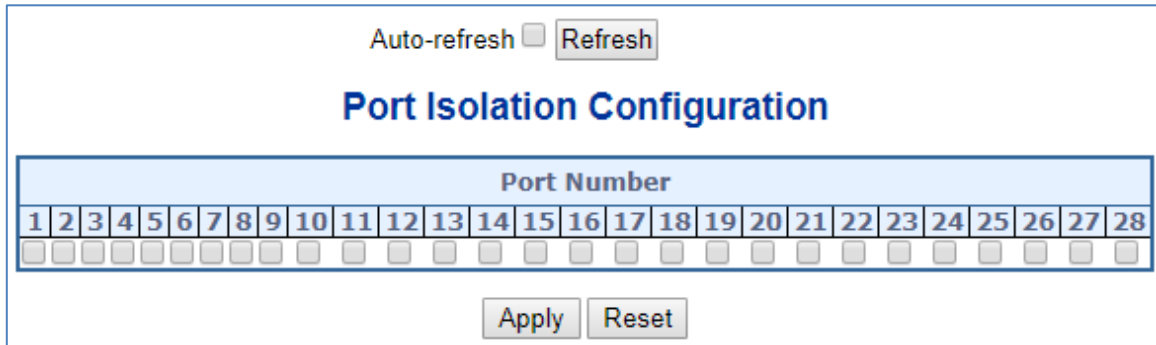

Figure 4-3-3-6: Port Isolation Configuration Page Screenshot

The page includes the following fields:

Object	Description
<ul style="list-style-type: none"> <li>• <b>Port Members</b></li> </ul>	<p>A check box is provided for each port of a private VLAN. When checked, port isolation is enabled on that port. When unchecked, port isolation is disabled on that port.</p> <p>By default, port isolation is <b>disabled</b> on all ports.</p>

### Buttons

: Click to apply changes

: Click to undo any changes made locally and revert to previously saved values.

Auto-refresh  Check this box to refresh the page automatically. Automatic refresh occurs every 3 seconds.

: Click to refresh the page immediately.



#### 4.3.3.8 VLAN setting example:

- Separate VLAN
- 802.1Q VLAN Trunk
- Port Isolate

##### 4.3.3.8.1 Two Separate 802.1Q VLANs

The diagram shows how the **Industrial Managed Switch** handle Tagged and Untagged traffic flow for two VLANs. VLAN Group 2 and VLAN Group 3 are separated VLAN. Each VLAN isolate network traffic so only members of the VLAN receive traffic from the same VLAN members. The screen in [Figure 4-3-3-7](#) appears and [Table 4-3-3-8](#) describes the port configuration of the **Industrial Managed Switches**.

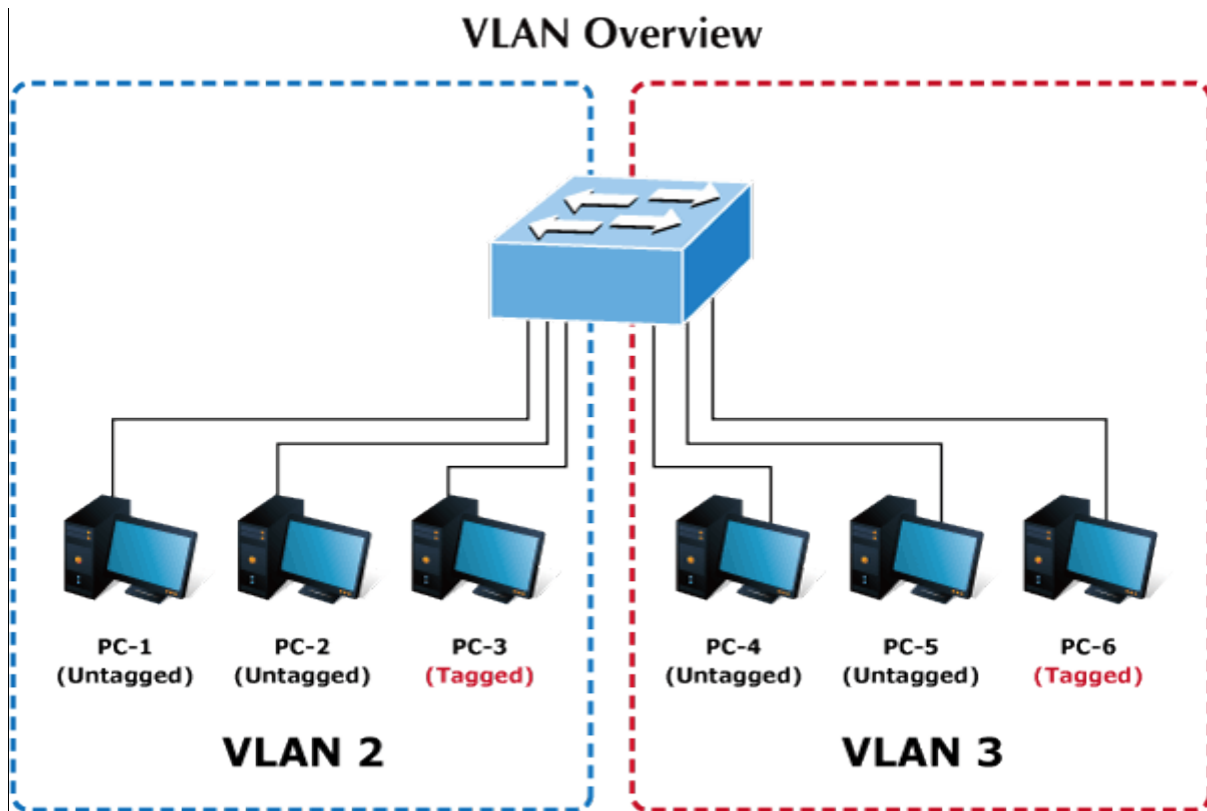

Figure 4-3-3-7: Two Separate VLANs Diagram

VLAN Group	VID	Untagged Members	Tagged Members
VLAN Group 1	1	Port-7 ~ Port-52	N/A
VLAN Group 2	2	Port-1,Port-2	Port-3
VLAN Group 3	3	Port-4,Port-5	Port-6

Table 4-1: VLAN and Port Configuration

The scenario is described as follows:

- **Untagged packet entering VLAN 2**
  1. While [PC-1] transmit an **untagged** packet enters **Port-1**, the **Industrial Managed Switch** will tag it with a **VLAN Tag=2**. [PC-2] and [PC-3] will received the packet through **Port-2** and **Port-3**.

2. [PC-4],[PC-5] and [PC-6] received no packet.
3. While the packet leaves **Port-2**, it will be stripped away its tag becoming an **untagged** packet.
4. While the packet leaves **Port-3**, it will keep as a **tagged** packet with **VLAN Tag=2**.
  - **Tagged packet entering VLAN 2**
5. While [PC-3] transmits a **tagged** packet with **VLAN Tag=2** enters **Port-3**, [PC-1] and [PC-2] will receive the packet through **Port-1** and **Port-2**.
6. While the packet leaves **Port-1** and **Port-2**, it will be stripped away its tag becoming an **untagged** packet.
  - **Untagged packet entering VLAN 3**
    1. While [PC-4] transmits an **untagged** packet enters **Port-4**, the switch will tag it with a **VLAN Tag=3**. [PC-5] and [PC-6] will receive the packet through **Port-5** and **Port-6**.
    2. While the packet leaves **Port-5**, it will be stripped away its tag becoming an **untagged** packet.
    3. While the packet leaves **Port-6**, it will keep as a **tagged** packet with **VLAN Tag=3**.



For this example, VLAN Group 1 is just set as default VLAN, but only focus on VLAN 2 and VLAN 3 traffic flow

### Setup steps

#### 1. Add VLAN Group

Add two VLANs – VLAN 2 and VLAN 3

Type 1-3 in Allowed Access VLANs column, the 1-3 is including VLAN1 and 2 and 3.

Global VLAN Configuration	
Allowed Access VLANs	1-3
Ethertype for Custom S-ports	88A8

Figure 4-3-3-8: Add VLAN 2 and VLAN 3

#### 2. Assign VLAN Member and PVID for each port:

VLAN 2 : Port-1,Port-2 and Port-3

VLAN 3 : Port-4, Port-5 and Port-6

VLAN 1 : All other ports – Port-7~Port-52

Global VLAN Configuration								
Allowed Access VLANs		1-3						
Ethertype for Custom S-ports		88A8						
Port VLAN Configuration								
Port	Mode	Port VLAN	Port Type	Ingress Filtering	Ingress Acceptance	Egress Tagging	Allowed VLANs	Forbidden VLANs
*	<All>	2	<All>	<input type="checkbox"/>	<All>	<All>	2	
1	Access	2	C-Port	<input checked="" type="checkbox"/>	Tagged and Untagged	Untag Port VLAN	2	
2	Access	2	C-Port	<input checked="" type="checkbox"/>	Tagged and Untagged	Untag Port VLAN	2	
3	Access	2	C-Port	<input checked="" type="checkbox"/>	Tagged and Untagged	Untag Port VLAN	2	
4	Access	3	C-Port	<input checked="" type="checkbox"/>	Tagged and Untagged	Untag Port VLAN	3	
5	Access	3	C-Port	<input checked="" type="checkbox"/>	Tagged and Untagged	Untag Port VLAN	3	
6	Access	3	C-Port	<input checked="" type="checkbox"/>	Tagged and Untagged	Untag Port VLAN	3	
7	Access	1	C-Port	<input checked="" type="checkbox"/>	Tagged and Untagged	Untag Port VLAN	1	
8	Access	1	C-Port	<input checked="" type="checkbox"/>	Tagged and Untagged	Untag Port VLAN	1	
9	Access	1	C-Port	<input checked="" type="checkbox"/>	Tagged and Untagged	Untag Port VLAN	1	
10	Access	1	C-Port	<input checked="" type="checkbox"/>	Tagged and Untagged	Untag Port VLAN	1	

Figure 4-3-3-9: Change Port VLAN of Port 1~3 to be VLAN2 and Port VLAN of Port 4~6 to be VLAN3

### 3. Enable VLAN Tag for specific ports

Link Type: *Port-3* (VLAN-2) and *Port-6* (VLAN-3)

Change Port 3 Mode as Trunk, Selects Egress Tagging as Tag All and Types 2 in the Allowed VLANs column.

Change Port 6 Mode as Trunk and Selects Egress Tagging as Tag All and Types 3 in the Allowed VLANs column.

The Per Port VLAN configuration in Figure 4-3-3-10 appears.

Global VLAN Configuration								
Allowed Access VLANs		1-3						
Ethertype for Custom S-ports		88A8						
Port VLAN Configuration								
Port	Mode	Port VLAN	Port Type	Ingress Filtering	Ingress Acceptance	Egress Tagging	Allowed VLANs	Forbidden VLANs
*	<All>	2	<All>	<input type="checkbox"/>	<All>	<All>	2	
1	Access	2	C-Port	<input checked="" type="checkbox"/>	Tagged and Untagged	Untag Port VLAN	2	
2	Access	2	C-Port	<input checked="" type="checkbox"/>	Tagged and Untagged	Untag Port VLAN	2	
3	Trunk	2	C-Port	<input checked="" type="checkbox"/>	Tagged Only	Tag All	2	
4	Access	3	C-Port	<input checked="" type="checkbox"/>	Tagged and Untagged	Untag Port VLAN	3	
5	Access	3	C-Port	<input checked="" type="checkbox"/>	Tagged and Untagged	Untag Port VLAN	3	
6	Trunk	3	C-Port	<input checked="" type="checkbox"/>	Tagged Only	Tag All	3	
7	Access	1	C-Port	<input checked="" type="checkbox"/>	Tagged and Untagged	Untag Port VLAN	1	

Figure 4-3-3-10: Check VLAN 2 and 3 Members on VLAN Membership Page

#### 4.3.3.8.2 VLAN Trunking between two 802.1Q aware switches

The most cases are used for “Uplink” to other switches. VLANs are separated at different switches, but they need to access with other switches within the same VLAN group. The screen in Figure 4-3-3-11 appears.

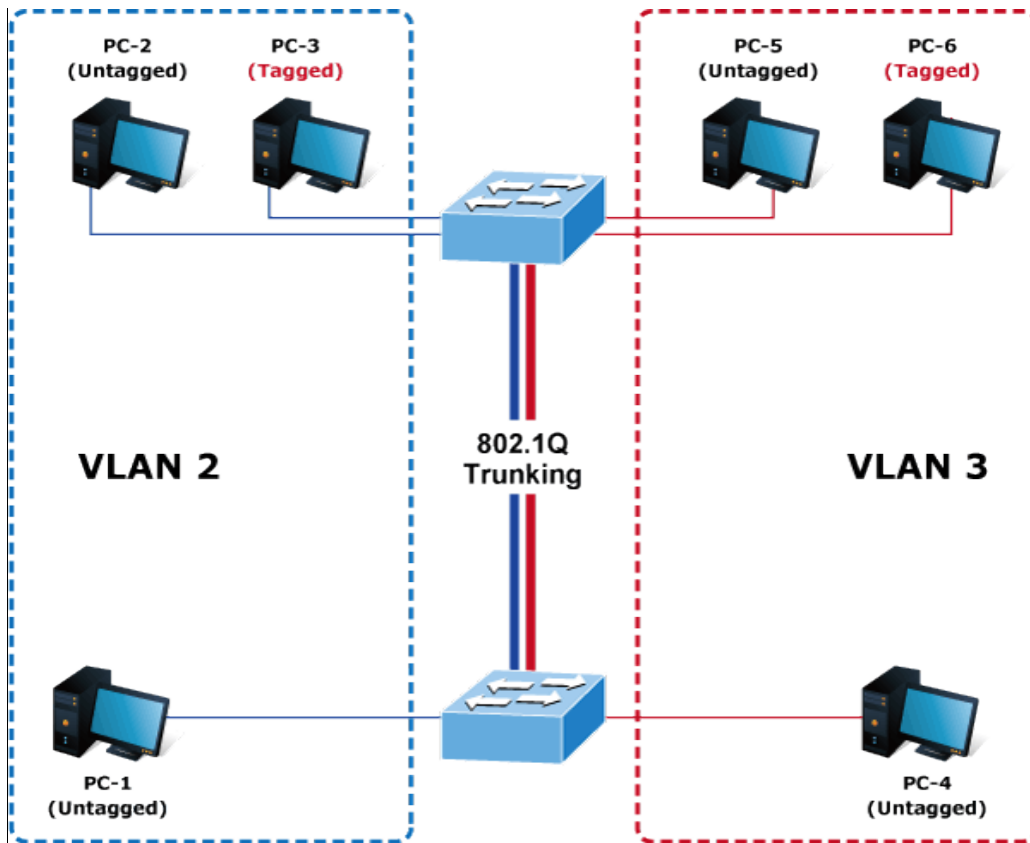

Figure 4-3-3-11: VLAN Trunking Diagram

**Setup steps**

**1. Add VLAN Group**

Add two VLANs – VLAN 2 and VLAN 3

Type 1-3 in Allowed Access VLANs column, the 1-3 is including VLAN1 and 2 and 3.

Global VLAN Configuration	
Allowed Access VLANs	1-3
Ethertype for Custom S-ports	88A8

Figure 4-3-3-12: Add VLAN 2 and VLAN 3

**2. Assign VLAN Member and PVID for each port :**

VLAN 2 : Port-1,Port-2 and Port-3

VLAN 3 : Port-4, Port-5 and Port-6

VLAN 1 : All other ports – Port-7~Port-52

### Global VLAN Configuration

Allowed Access VLANs	1-3
Ethertype for Custom S-ports	88A8

### Port VLAN Configuration

Port	Mode	Port VLAN	Port Type	Ingress Filtering	Ingress Acceptance	Egress Tagging	Allowed VLANs	Forbidden VLANs
*	<All>	2	<All>	<input type="checkbox"/>	<All>	<All>	2	
1	Access	2	C-Port	<input checked="" type="checkbox"/>	Tagged and Untagged	Untag All	1	
2	Access	2	C-Port	<input checked="" type="checkbox"/>	Tagged and Untagged	Untag All	1	
3	Access	2	C-Port	<input checked="" type="checkbox"/>	Tagged and Untagged	Untag All	1	
4	Access	2	C-Port	<input checked="" type="checkbox"/>	Tagged and Untagged	Untag All	1	
5	Access	2	C-Port	<input checked="" type="checkbox"/>	Tagged and Untagged	Untag All	1	
6	Access	2	C-Port	<input checked="" type="checkbox"/>	Tagged and Untagged	Untag All	1	
7	Access	2	C-Port	<input checked="" type="checkbox"/>	Tagged and Untagged	Untag All	1	
8	Access	2	C-Port	<input checked="" type="checkbox"/>	Tagged and Untagged	Untag All	1	
9	Access	2	C-Port	<input checked="" type="checkbox"/>	Tagged and Untagged	Untag All	1	
10	Access	2	C-Port	<input checked="" type="checkbox"/>	Tagged and Untagged	Untag All	1	

Apply Reset

Figure 4-3-3-13: Changes Port VLAN of Port 1~3 to be VLAN2 and Port VLAN of Port 4~6 to be VLAN3

For the VLAN ports connecting to the hosts, please refer to 4.6.10.1 examples. The following steps will focus on the VLAN **Trunk port** configuration.

1. Specify **Port-7** to be the 802.1Q VLAN **Trunk port**.
2. Assign **Port-7** to both **VLAN 2** and **VLAN 3** at the VLAN Member configuration page.
3. Define a **VLAN 1** as a “**Public Area**” that overlapping with both **VLAN 2 members** and **VLAN 3 members**.
4. Assign the VLAN Trunk Port to be the member of each VLAN – which wants to be aggregated. For this example, add **Port-7** to be **VLAN 2** and **VLAN 3** member port.
5. Specify **Port-7** to be the 802.1Q VLAN **Trunk port**, and the Trunking port must be a **Tagged** port while egress. The Port-7 configuration is shown in [Figure 4-3-3-14](#).

### Global VLAN Configuration

Allowed Access VLANs	1-3
Ethertype for Custom S-ports	88A8

### Port VLAN Configuration

Port	Mode	Port VLAN	Port Type	Ingress Filtering	Ingress Acceptance	Egress Tagging	Allowed VLANs	Forbidden VLANs
*	<All>	2	<All>	<input type="checkbox"/>	<All>	<All>	2	1
1	Access	2	C-Port	<input checked="" type="checkbox"/>	Tagged and Untagged	Untag Port VLAN	2	1
2	Access	2	C-Port	<input checked="" type="checkbox"/>	Tagged and Untagged	Untag Port VLAN	2	1
3	Access	2	C-Port	<input checked="" type="checkbox"/>	Tagged and Untagged	Untag Port VLAN	2	1
4	Access	3	C-Port	<input checked="" type="checkbox"/>	Tagged and Untagged	Untag Port VLAN	3	1
5	Access	3	C-Port	<input checked="" type="checkbox"/>	Tagged and Untagged	Untag Port VLAN	3	1
6	Access	3	C-Port	<input checked="" type="checkbox"/>	Tagged and Untagged	Untag Port VLAN	3	1
7	Trunk	1	C-Port	<input checked="" type="checkbox"/>	Tagged Only	Tag All	1-3	
8	Access	1	C-Port	<input checked="" type="checkbox"/>	Tagged and Untagged	Untag Port VLAN	1	

Figure 4-3-3-14: VLAN Overlap Port Setting & VLAN 1 – The Public Area Member Assign

That is, although the VLAN 2 members: Port-1 to Port-3 and VLAN 3 members: Port-4 to Port-6 also belongs to VLAN 1. But with different PVID settings, packets from VLAN 2 or VLAN 3 is not able to access to the other VLAN.

6. Repeat Steps 1 to 6, set up the VLAN Trunk port at the partner switch and add more VLANs to join the VLAN trunk, repeat Steps 1 to 3 to assign the Trunk port to the VLANs.

#### 4.3.3.8.3 Port Isolate

The diagram shows how the **Industrial Managed Switch** handles isolated and promiscuous ports, and the each PC is not able to access the isolated port of each other's PCs. But they all need to access with the same server/AP/Printer. This section will show you how to configure the port for the server – that could be accessed by each isolated port.

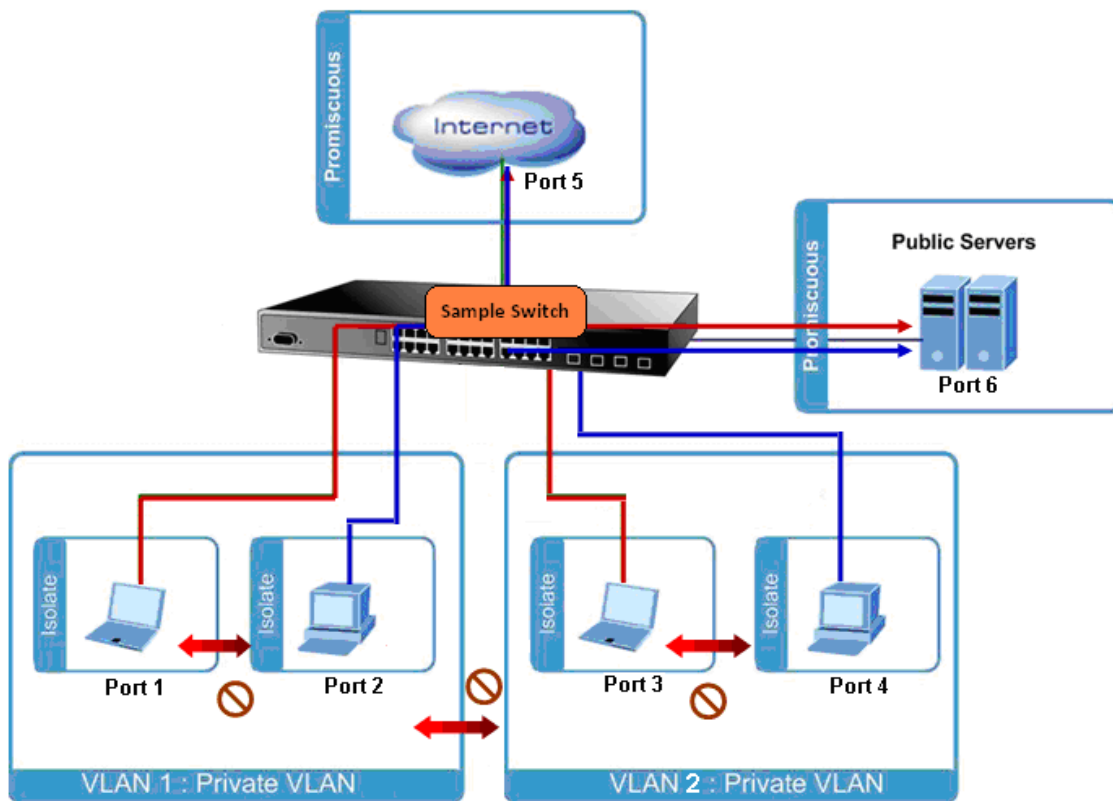

#### Setup steps

##### 1. Assign Port Mode

Set Port-1~Port-4 in Isolate port.

Set Port5 and Port-6 in Promiscuous port. The screen in [Figure 4-3-3-15](#) appears.

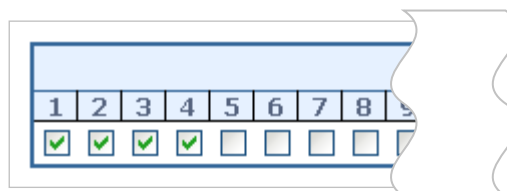
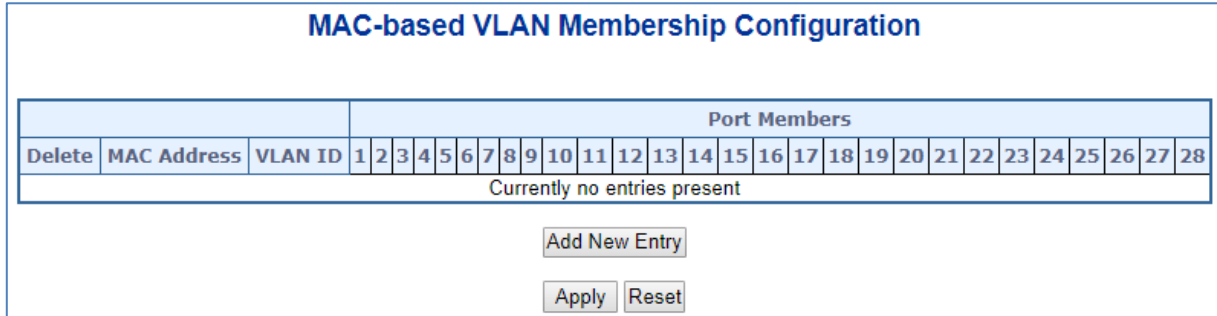

Figure 4-3-3-15: The Configuration of Isolated and Promiscuous Port

### 4.3.3.9 MAC-based VLAN

The MAC-based VLAN entries can be configured here. This page allows for adding and deleting MAC-based VLAN entries and assigning the entries to different ports. This page shows only static entries. The MAC-based VLAN screen in [Figure 4-3-3-16](#) appears.



**Figure 4-3-3-16:** MAC-based VLAN Membership Configuration Page Screenshot

The page includes the following fields:

Object	Description
<ul style="list-style-type: none"> <li>• <b>Delete</b></li> </ul>	To delete a MAC-based VLAN entry, check this box and press save.
<ul style="list-style-type: none"> <li>• <b>MAC Address</b></li> </ul>	Indicates the MAC address.
<ul style="list-style-type: none"> <li>• <b>VLAN ID</b></li> </ul>	Indicates the VLAN ID.
<ul style="list-style-type: none"> <li>• <b>Port Members</b></li> </ul>	A row of check boxes for each port is displayed for each MAC-based VLAN entry. To include a port in a MAC-based VLAN, check the box. To remove or exclude the port from the MAC-based VLAN, make sure the box is unchecked. By default, no ports are members, and all boxes are unchecked.
<ul style="list-style-type: none"> <li>• <b>Adding a New MAC-based VLAN</b></li> </ul>	Click "Add New Entry" to add a new MAC-based VLAN entry. An empty row is added to the table, and the MAC-based VLAN entry can be configured as needed. Any unicast MAC address can be configured for the MAC-based VLAN entry. No broadcast or multicast MAC addresses are allowed. Legal values for a VLAN ID are 1 through 4095.  The MAC-based VLAN entry is enabled when you click on "Save". A MAC-based VLAN without any port members will be deleted when you click "Save".  The "Delete" button can be used to undo the addition of new MAC-based VLANs.

#### Buttons

: Click to add a new MAC-based VLAN entry.

: Click to apply changes

: Click to undo any changes made locally and revert to previously saved values.

Auto-refresh  : Check this box to refresh the page automatically. Automatic refresh occurs every 3 seconds.

: Click to refresh the page immediately.



: Updates the table starting from the first entry in the MAC-based VLAN Table.

: Updates the table, starting with the entry after the last entry currently displayed.

#### 4.3.3.10 IP Subnet-based VLAN Membership Configuration

The IP subnet to VLAN ID mappings can be configured here. This page allows adding, updating and deleting IP subnet to VLAN ID mapping entries and assigning them to different ports. The MAC-based VLAN screen in [Figure 4-3-3-17](#) appears.

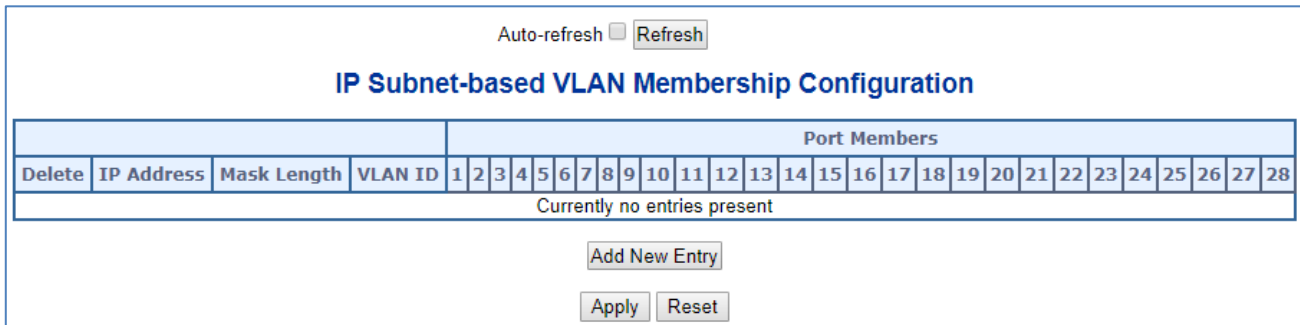





Figure 4-3-3-17: IP Subnet-based VLAN Membership Configuration page screenshot

The page includes the following fields:

Object	Description
• <b>Delete</b>	To delete a MAC-based VLAN entry, check this box and press save.
• <b>IP Address</b>	Indicates the subnet's IP address (Any of the subnet's host addresses can be also provided here, the application will convert it automatically).
• <b>Mask Length</b>	Indicates the subnet's mask length.
• <b>VLAN ID</b>	Indicates the VLAN ID the subnet will be mapped to. IP Subnet to VLAN ID is a unique matching.
• <b>Port Members</b>	A row of check boxes for each port is displayed for each IP subnet to VLAN ID mapping entry. To include a port in a mapping, simply check the box. To remove or exclude the port from the mapping, make sure the box is unchecked. By default, no ports are members and all boxes are unchecked.
• <b>Adding a New IP subnet-based VLAN</b>	Click  to add a new IP subnet to VLAN ID mapping entry. An empty row is added to the table, and the mapping can be configured as needed. Any IP address/mask can be configured for the mapping. Legal values for the VLAN ID are <b>1</b> to <b>4095</b> .  The IP subnet to VLAN ID mapping entry is enabled when you click on "Apply".  The  delete button can be used to undo the addition of new mappings. The maximum possible IP subnet to VLAN ID mappings are limited to 128

#### Buttons

: Click to apply changes

: Click to undo any changes made locally and revert to previously saved values.



Auto-refresh  Check this box to refresh the page automatically. Automatic refresh occurs every 3 seconds.

: Click to refresh the page immediately.

### 4.3.3.11 Protocol-based VLAN

This page allows you to add new protocols to Group Name (unique for each Group) mapping entries as well as allow you to see and delete already mapped entries for the switch. The Protocol-based VLAN screen in [Figure 4-3-3-18](#) appears.

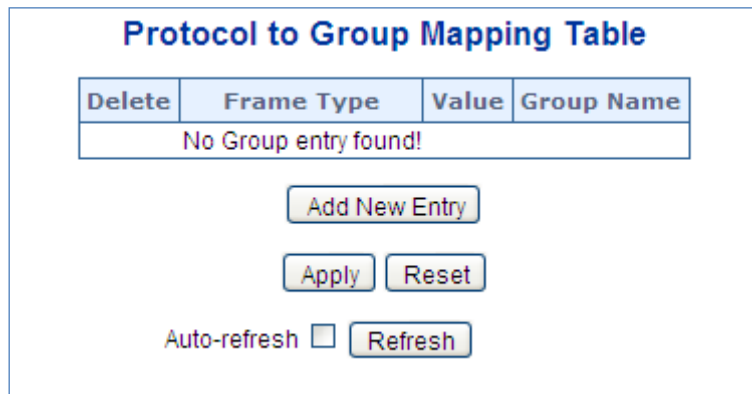



Figure 4-3-3-18: Protocol to Group Mapping Table Page Screenshot

The page includes the following fields:

Object	Description
<ul style="list-style-type: none"> <li>• <b>Delete</b></li> </ul>	To delete a Protocol to Group Name map entry, check this box. The entry will be deleted on the switch during the next Save.
<ul style="list-style-type: none"> <li>• <b>Frame Type</b></li> </ul>	<p>Frame Type can have one of the following values:</p> <ol style="list-style-type: none"> <li>1. <b>Ethernet</b></li> <li>2. <b>LLC</b></li> <li>3. <b>SNAP</b></li> </ol> <p>Note: On changing the Frame type field, valid value of the following text field will vary depending on the new frame type you selected.</p>
<ul style="list-style-type: none"> <li>• <b>Value</b></li> </ul>	<p>Valid value that can be entered in this text field depends on the option selected from the preceding Frame Type selection menu.</p> <p>Below is the criteria for three different Frame Types:</p> <ol style="list-style-type: none"> <li>1. <b>For Ethernet:</b> Values in the text field when Ethernet is selected as a Frame Type is called etype. Valid values for etype ranges from 0x0600-0xffff</li> <li>2. <b>For LLC:</b> Valid value in this case is comprised of two different sub-values. <ol style="list-style-type: none"> <li>a. <b>DSAP:</b> 1-byte long string (0x00-0xff)</li> <li>b. <b>SSAP:</b> 1-byte long string (0x00-0xff)</li> </ol> </li> <li>3. <b>For SNAP:</b> Valid value in this case also is comprised of two different</li> </ol>

	<p>sub-values.</p> <ol style="list-style-type: none"> <li><b>OUI:</b> OUI (Organizationally Unique Identifier) is value in format of xx-xx-xx where each pair (xx) in string is a hexadecimal value ranges from 0x00-0xff.</li> <li><b>PID:</b> If the OUI is hexadecimal 000000, the protocol ID is the Ethernet type (EtherType) field value for the protocol running on top of SNAP; if the OUI is an OUI for a particular organization, the protocol ID is a value assigned by that organization to the protocol running on top of SNAP.</li> </ol> <p>In other words, if value of OUI field is 00-00-00 then value of PID will be etype (0x0600-0xffff) and if value of OUI is other than 00-00-00 then valid value of PID will be any value from 0x0000 to 0xffff.</p>
<ul style="list-style-type: none"> <li><b>Group Name</b></li> </ul>	<p>A valid Group Name is a unique 16-character long string for every entry which consists of a combination of alphabets (a-z or A-Z) and integers(0-9).</p> <p><b>Note:</b> special character and underscore(_) are not allowed.</p>
<ul style="list-style-type: none"> <li><b>Adding a New Group to VLAN mapping entry</b></li> </ul>	<p>Click "Add New Entry" to add a new entry in mapping table. An empty row is added to the table; Frame Type, Value and the Group Name can be configured as needed.</p> <p>The "Delete" button can be used to undo the addition of new entry.</p>

**Buttons**

 : Click to add a new entry in mapping table.

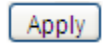
 : Click to apply changes

 : Click to undo any changes made locally and revert to previously saved values.

Auto-refresh  Check this box to refresh the page automatically. Automatic refresh occurs every 3 seconds.

 : Click to refresh the page immediately.

**4.3.3.12 Protocol-based VLAN Membership**

This page allows you to map a already configured Group Name to a VLAN for the switch. The Group Name to VLAN Mapping Table screen in [Figure 4-6-19](#) appears.



**Figure 4-3-19:** Group Name to VLAN Mapping Table Page Screenshot



The page includes the following fields:

Object	Description
<ul style="list-style-type: none"> <li>• <b>Delete</b></li> </ul>	To delete a Group Name to VLAN map entry, check this box. The entry will be deleted on the switch during the next Save
<ul style="list-style-type: none"> <li>• <b>Group Name</b></li> </ul>	A valid Group Name is a string of almost 16 characters which consists of a combination of alphabets (a-z or A-Z) and integers(0-9), no special character is allowed. Whichever Group name you try map to a VLAN must be present in Protocol to Group mapping table and must not be preused by any other existing mapping entry on this page.
<ul style="list-style-type: none"> <li>• <b>VLAN ID</b></li> </ul>	Indicates the ID to which Group Name will be mapped. A valid VLAN ID ranges from 1-4095.
<ul style="list-style-type: none"> <li>• <b>Port Members</b></li> </ul>	A row of check boxes for each port is displayed for each Group Name to VLAN ID mapping. To include a port in a mapping, check the box. To remove or exclude the port from the mapping, make sure the box is unchecked. By default, no ports are members, and all boxes are unchecked.
<ul style="list-style-type: none"> <li>• <b>Adding a New Group to VLAN mapping entry</b></li> </ul>	Click "Add New Entry" to add a new entry in mapping table. An empty row is added to the table, the Group Name, VLAN ID and port members can be configured as needed. Legal values for a VLAN ID are 1 through 4095. The "Delete" button can be used to undo the addition of new entry.

**Buttons**



: Click to apply changes



: Click to undo any changes made locally and revert to previously saved values.

Auto-refresh

Check this box to refresh the page automatically. Automatic refresh occurs every 3 seconds.

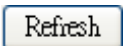

: Click to refresh the page immediately.

## 4.3.4 Spanning Tree Protocol

### 4.3.4.1 Theory

The Spanning Tree protocol can be used to detect and disable network loops, and to provide backup links between switches, bridges or routers. This allows the switch to interact with other bridging devices in your network to ensure that only one route exists between any two stations on the network, and provide backup links which automatically take over when a primary link goes down. The spanning tree algorithms supported by this switch include these versions:

- **STP – Spanning Tree Protocol (IEEE 802.1D)**
- **RSTP – Rapid Spanning Tree Protocol (IEEE 802.1w)**
- **MSTP – Multiple Spanning Tree Protocol (IEEE 802.1s)**

The **IEEE 802.1D Spanning Tree** Protocol and **IEEE 802.1w Rapid Spanning Tree** Protocol allow for the blocking of links between switches that form loops within the network. When multiple links between switches are detected, a primary link is established. Duplicated links are blocked from use and become standby links. The protocol allows for the duplicate links to be used in the event of a failure of the primary link. Once the Spanning Tree Protocol is configured and enabled, primary links are established and duplicated links are blocked automatically. The reactivation of the blocked links (at the time of a primary link failure) is also accomplished automatically without operator intervention.

This automatic network reconfiguration provides maximum uptime to network users. However, the concepts of the Spanning Tree Algorithm and protocol are a complicated and complex subject and must be fully researched and understood. It is possible to cause serious degradation of the performance of the network if the Spanning Tree is incorrectly configured. Please read the following before making any changes from the default values.

The Switch STP performs the following functions:

- Creates a single spanning tree from any combination of switching or bridging elements.
- Creates multiple spanning trees – from any combination of ports contained within a single switch, in user specified groups.
- Automatically reconfigures the spanning tree to compensate for the failure, addition, or removal of any element in the tree.
- Reconfigures the spanning tree without operator intervention.

### Bridge Protocol Data Units

For STP to arrive at a stable network topology, the following information is used:

- The unique switch identifier
- The path cost to the root associated with each switch port
- The port identifier

STP communicates between switches on the network using Bridge Protocol Data Units (BPDUs). Each BPDU contains the following information:

- The unique identifier of the switch that the transmitting switch currently believes is the root switch
- The path cost to the root from the transmitting port

- The port identifier of the transmitting port

The switch sends BPDUs to communicate and construct the spanning-tree topology. All switches connected to the LAN on which the packet is transmitted will receive the BPDU. BPDUs are not directly forwarded by the switch, but the receiving switch uses the information in the frame to calculate a BPDU, and, if the topology changes, initiates a BPDU transmission.

The communication between switches via BPDUs results in the following:

- One switch is elected as the root switch
- The shortest distance to the root switch is calculated for each switch
- A designated switch is selected. This is the switch closest to the root switch through which packets will be forwarded to the root.
- A port for each switch is selected. This is the port providing the best path from the switch to the root switch.
- Ports included in the STP are selected.

### **Creating a Stable STP Topology**

It is to make the root port a fastest link. If all switches have STP enabled with default settings, the switch with the lowest MAC address in the network will become the root switch. By increasing the priority (lowering the priority number) of the best switch, STP can be forced to select the best switch as the root switch.

When STP is enabled using the default parameters, the path between source and destination stations in a switched network might not be ideal. For instance, connecting higher-speed links to a port that has a higher number than the current root port can cause a root-port change.

### **STP Port States**

The BPDUs take some time to pass through a network. This propagation delay can result in topology changes where a port that transitioned directly from a Blocking state to a Forwarding state could create temporary data loops. Ports must wait for new network topology information to propagate throughout the network before starting to forward packets. They must also wait for the packet lifetime to expire for BPDU packets that were forwarded based on the old topology. The forward delay timer is used to allow the network topology to stabilize after a topology change. In addition, STP specifies a series of states a port must transition through to further ensure that a stable network topology is created after a topology change.

**Each port on a switch using STP exists in one of the following five states:**

- **Blocking** – the port is blocked from forwarding or receiving packets
- **Listening** – the port is waiting to receive BPDU packets that may tell the port to go back to the blocking state
- **Learning** – the port is adding addresses to its forwarding database, but not yet forwarding packets
- **Forwarding** – the port is forwarding packets
- **Disabled** – the port only responds to network management messages and must return to the blocking state first

**A port transitions from one state to another as follows:**

- From initialization (switch boot) to blocking
- From blocking to listening or to disabled
- From listening to learning or to disabled
- From learning to forwarding or to disabled
- From forwarding to disabled

- From disabled to blocking

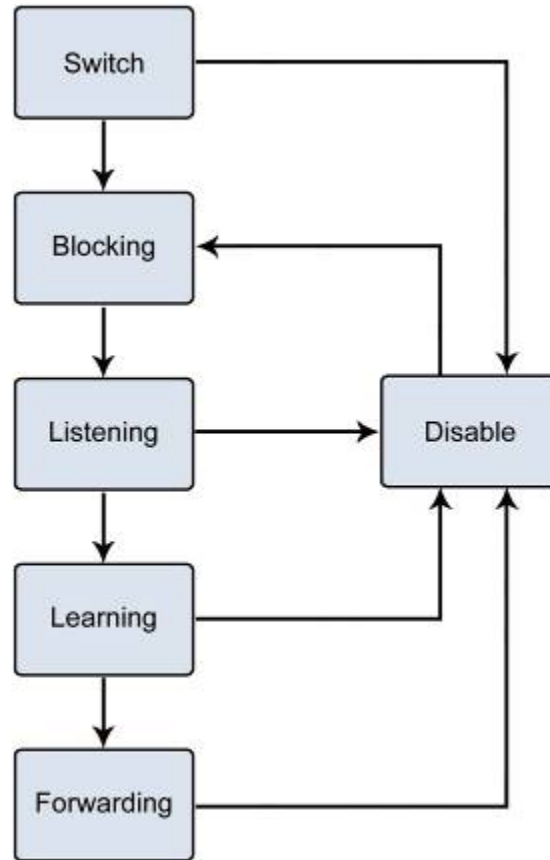

**Figure 4-3-4-1:** STP Port State Transitions

You can modify each port state by using management software. When you enable STP, every port on every switch in the network goes through the blocking state and then transitions through the states of listening and learning at power up. If properly configured, each port stabilizes to the forwarding or blocking state. No packets (except BPDUs) are forwarded from, or received by, STP enabled ports until the forwarding state is enabled for that port.

## 2. STP Parameters

### STP Operation Levels

The Switch allows for two levels of operation: the switch level and the port level. The switch level forms a spanning tree consisting of links between one or more switches. The port level constructs a spanning tree consisting of groups of one or more ports. The STP operates in much the same way for both levels.

 <b>Note</b>	<p>On the switch level, STP calculates the Bridge Identifier for each switch and then sets the Root Bridge and the Designated Bridges.</p> <p>On the port level, STP sets the Root Port and the Designated Ports.</p>
--	---

The following are the user-configurable STP parameters for the switch level:

Parameter	Description	Default Value
<b>Bridge Identifier(Not user configurable except by setting priority below)</b>	A combination of the User-set priority and the switch's MAC address.  The Bridge Identifier consists of two parts: a 16-bit priority and a 48-bit Ethernet MAC address 32768 + MAC	32768 + MAC
<b>Priority</b>	A relative priority for each switch – lower numbers give a higher priority and a greater chance of a given switch being elected as the root bridge	32768
<b>Hello Time</b>	The length of time between broadcasts of the hello message by the switch	2 seconds
<b>Maximum Age Timer</b>	Measures the age of a received BPDU for a port and ensures that the BPDU is discarded when its age exceeds the value of the maximum age timer.	20 seconds
<b>Forward Delay Timer</b>	The amount time spent by a port in the learning and listening states waiting for a BPDU that may return the port to the blocking state.	15 seconds

The following are the user-configurable STP parameters for the port or port group level:

Variable	Description	Default Value
<b>Port Priority</b>	A relative priority for each port –lower numbers give a higher priority and a greater chance of a given port being elected as the root port	128
<b>Port Cost</b>	A value used by STP to evaluate paths – STP calculates path costs and selects the path with the minimum cost as the active path	200,000-100Mbps Fast Ethernet ports 20,000-1000Mbps Gigabit Ethernet ports 0 - Auto

### Default Spanning-Tree Configuration

Feature	Default Value
Enable state	STP disabled for all ports
Port priority	128
Port cost	0
Bridge Priority	32,768



### User-Changeable STA Parameters

The Switch's factory default setting should cover the majority of installations. However, it is advisable to keep the default settings as set at the factory; unless, it is absolutely necessary. The user changeable parameters in the Switch are as follows:

**Priority** – A Priority for the switch can be set from 0 to 65535. 0 is equal to the highest Priority.

**Hello Time** – The Hello Time can be from 1 to 10 seconds. This is the interval between two transmissions of BPDU packets sent by the Root Bridge to tell all other Switches that it is indeed the Root Bridge. If you set a Hello Time for your Switch, and it is not the Root Bridge, the set Hello Time will be used if and when your Switch becomes the Root Bridge.

 Note	The Hello Time cannot be longer than the Max. Age; otherwise, a configuration error will occur.
---	---

**Max. Age** – The Max Age can be from 6 to 40 seconds. At the end of the Max Age, if a BPDU has still not been received from the Root Bridge, your Switch will start sending its own BPDU to all other Switches for permission to become the Root Bridge. If it turns out that your Switch has the lowest Bridge Identifier, it will become the Root Bridge.

**Forward Delay Timer** – The Forward Delay can be from 4 to 30 seconds. This is the time any port on the Switch spends in the listening state while moving from the blocking state to the forwarding state.

 Note	Observe the following formulas when setting the above parameters: <b>Max. Age _ 2 x (Forward Delay - 1 second)</b> <b>Max. Age _ 2 x (Hello Time + 1 second)</b>
---	--

**Port Priority** – A Port Priority can be from 0 to 240. The lower the number, the greater the probability the port will be chosen as the Root Port.

**Port Cost** – A Port Cost can be set from 0 to 200000000. The lower the number, the greater the probability the port will be chosen to forward packets.

### 3. Illustration of STP

A simple illustration of three switches connected in a loop is depicted in the below diagram. In this example, you can anticipate some major network problems if the STP assistance is not applied.

If switch A broadcasts a packet to switch B, switch B will broadcast it to switch C, and switch C will broadcast it to back to switch A and so on. The broadcast packet will be passed indefinitely in a loop, potentially causing a network failure. In this example, STP breaks the loop by blocking the connection between switch B and C. The decision to block a particular connection is based on the STP calculation of the most current Bridge and Port settings.

Now, if switch A broadcasts a packet to switch C, then switch C will drop the packet at port 2 and the broadcast will end there. Setting-up STP using values other than the defaults, can be complex. Therefore, you are advised to keep the default factory settings and STP will automatically assign root bridges/ports and block loop connections. Influencing STP to choose a particular switch as the root bridge using the Priority setting, or influencing STP to choose a particular port to block using the Port Priority and Port Cost settings is, however, relatively straight forward.

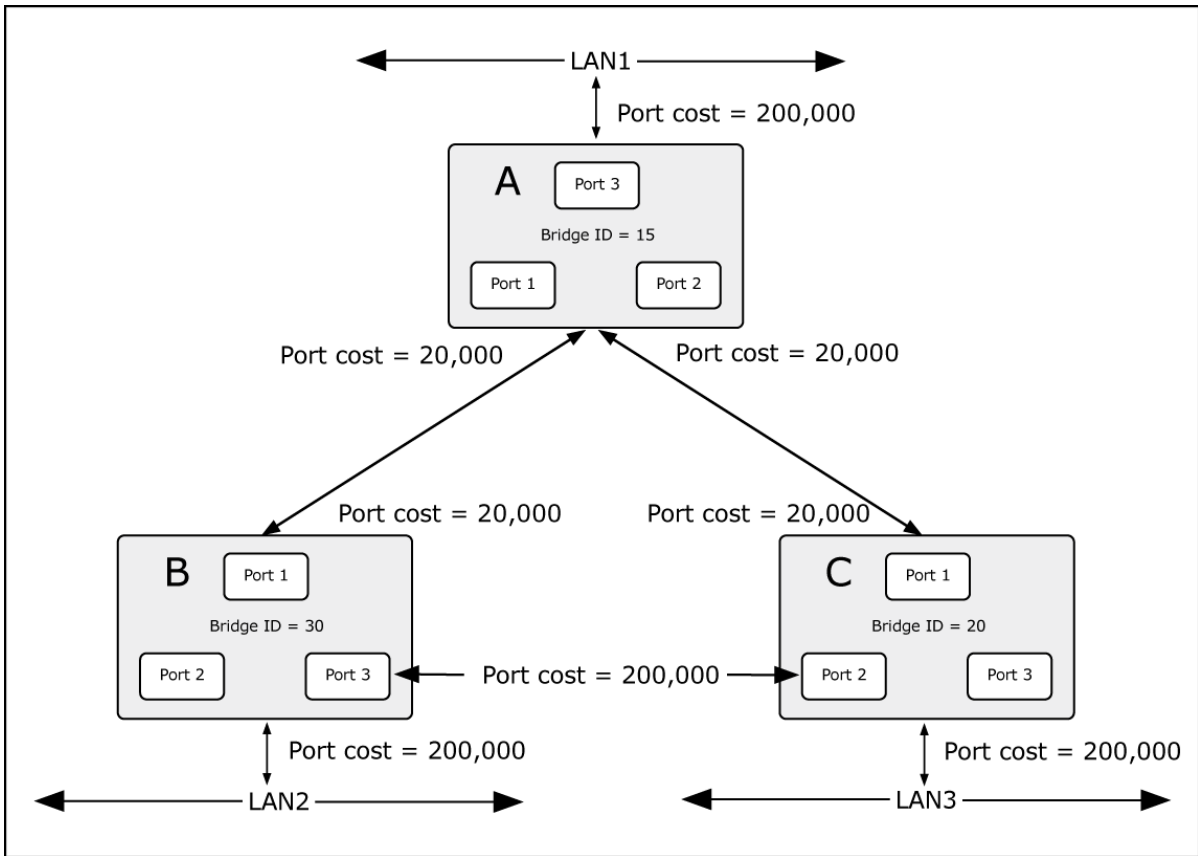

**Figure 4-3-4-2: Before Applying the STA Rules**

In this example, only the default STP values are used.

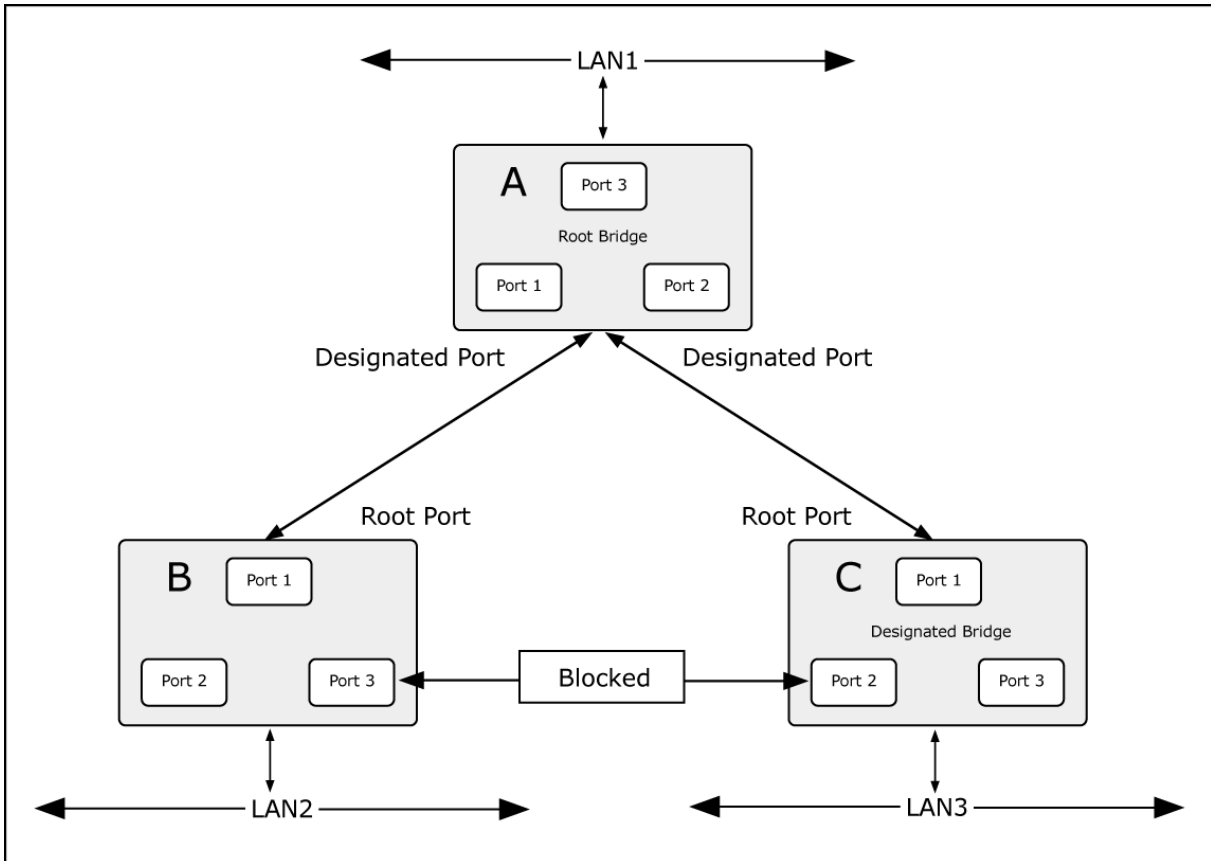

**Figure 4-3-4-3: After Applying the STA Rules**

The switch with the lowest Bridge ID (switch C) was elected the root bridge, and the ports were selected to give a high port cost

between switches B and C. The two (optional) Gigabit ports (default port cost = 20,000) on switch A are connected to one (optional) Gigabit port on both switch B and C. The redundant link between switch B and C is deliberately chosen as a 100 Mbps Fast Ethernet link (default port cost = 200,000). Gigabit ports could be used, but the port cost should be increased from the default to ensure that the link between switch B and switch C is the blocked link.

#### 4.3.4.2 STP System Configuration

This page allows you to configure STP system settings. The settings are used by all STP Bridge instances in the Switch. The **Industrial Managed Switch** support the following Spanning Tree protocols:

- **Compatible -- Spanning Tree Protocol (STP):** Provides a single path between end stations, avoiding and eliminating loops.
- **Normal -- Rapid Spanning Tree Protocol (RSTP) :** Detects and uses of network topologies that provide faster spanning tree convergence, without creating forwarding loops.
- **Extension – Multiple Spanning Tree Protocol (MSTP) :** Defines an extension to RSTP to further develop the usefulness of virtual LANs (VLANs). This "Per-VLAN" Multiple Spanning Tree Protocol configures a separate Spanning Tree for each VLAN group and blocks all but one of the possible alternate paths within each Spanning Tree.

The STP System Configuration screen in [Figure 4-3-4-4](#) appears.

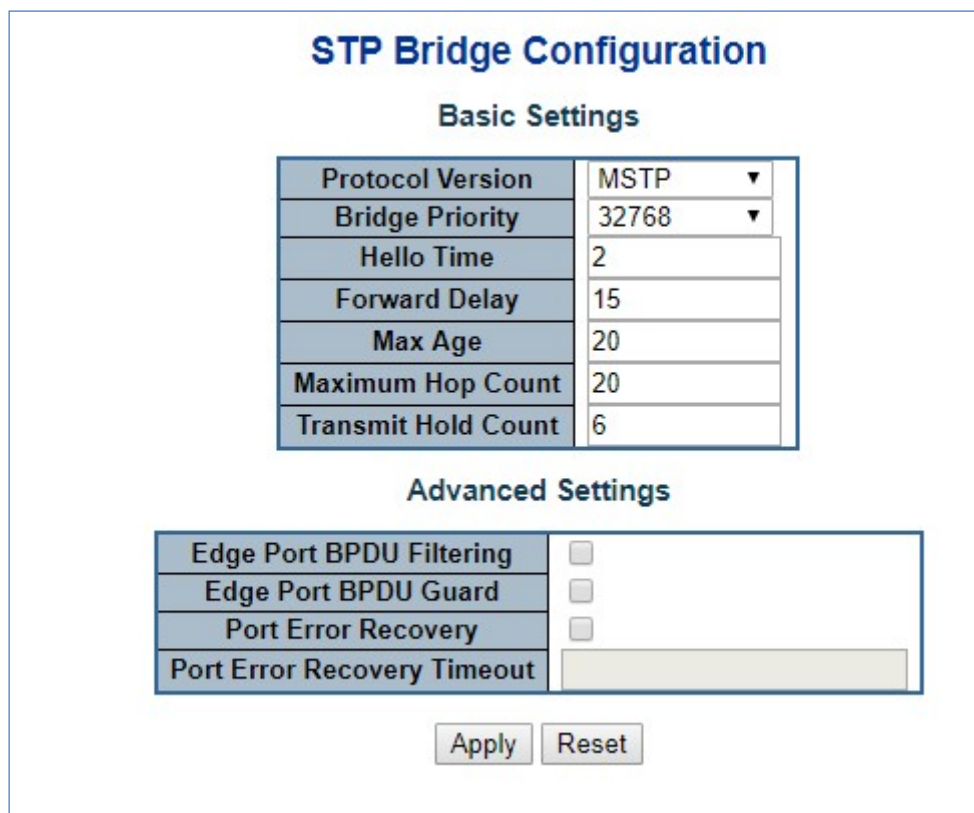

**STP Bridge Configuration**

**Basic Settings**

Protocol Version	MSTP ▼
Bridge Priority	32768 ▼
Hello Time	2
Forward Delay	15
Max Age	20
Maximum Hop Count	20
Transmit Hold Count	6

**Advanced Settings**

Edge Port BPDU Filtering	<input type="checkbox"/>
Edge Port BPDU Guard	<input type="checkbox"/>
Port Error Recovery	<input type="checkbox"/>
Port Error Recovery Timeout	<input style="width: 100%;" type="text"/>

**Figure 4-3-4-4:** STP Bridge Configuration Page Screenshot

The page includes the following fields:

## Basic Settings

Object	Description
<ul style="list-style-type: none"> <li>• <b>Protocol Version</b></li> </ul>	<p>The STP protocol version setting. Valid values are:</p> <ul style="list-style-type: none"> <li>■ <b>STP</b> (IEEE 802.1D Spanning Tree Protocol)</li> <li>■ <b>RSTP</b> (IEEE 802.2w Rapid Spanning Tree Protocol)</li> <li>■ <b>MSTP</b> (IEEE 802.1s Multiple Spanning Tree Protocol)</li> </ul>
<ul style="list-style-type: none"> <li>• <b>Bridge Priority</b></li> </ul>	<p>Controls the bridge priority. Lower numeric values have better priority. The bridge priority plus the MSTI instance number, concatenated with the 6-byte MAC address of the switch forms a Bridge Identifier.</p> <p>For MSTP operation, this is the priority of the CIST. Otherwise, this is the priority of the STP/RSTP bridge.</p>
<ul style="list-style-type: none"> <li>• <b>Hello Time</b></li> </ul>	<p>The interval between sending STP BPDU's. Valid values are in the range 1 to 10 seconds, default is 2 seconds</p>
<ul style="list-style-type: none"> <li>• <b>Forward Delay</b></li> </ul>	<p>The delay used by STP Bridges to transition Root and Designated Ports to Forwarding (used in STP compatible mode). Valid values are in the range 4 to 30 seconds</p> <p>-Default: 15</p> <p>-Minimum: The higher of 4 or <math>[(\text{Max. Message Age} / 2) + 1]</math></p> <p>-Maximum: 30</p>
<ul style="list-style-type: none"> <li>• <b>Max Age</b></li> </ul>	<p>The maximum age of the information transmitted by the Bridge when it is the Root Bridge. Valid values are in the range 6 to 40 seconds.</p> <p>-Default: 20</p> <p>-Minimum: The higher of 6 or <math>[2 \times (\text{Hello Time} + 1)]</math>.</p> <p>-Maximum: The lower of 40 or <math>[2 \times (\text{Forward Delay} - 1)]</math></p>
<ul style="list-style-type: none"> <li>• <b>Maximum Hop Count</b></li> </ul>	<p>This defines the initial value of remaining Hops for MSTI information generated at the boundary of an MSTI region. It defines how many bridges a root bridge can distribute its BPDU information. Valid values are in the range 6 to 40 hops.</p>
<ul style="list-style-type: none"> <li>• <b>Transmit Hold Count</b></li> </ul>	<p>The number of BPDU's a bridge port can send per second. When exceeded, transmission of the next BPDU will be delayed. Valid values are in the range 1 to 10 BPDU's per second.</p>

## Advanced Settings

Object	Description
<ul style="list-style-type: none"> <li>• <b>Edge Port BPDU Filtering</b></li> </ul>	<p>Control whether a port explicitly configured as Edge will transmit and receive BPDUs.</p>
<ul style="list-style-type: none"> <li>• <b>Edge Port BPDU Guard</b></li> </ul>	<p>Control whether a port explicitly configured as Edge will disable itself upon reception of a BPDU. The port will enter the error-disabled state, and will be removed from the active topology.</p>

<ul style="list-style-type: none"> <li>• <b>Port Error Recovery</b></li> </ul>	Control whether a port in the error-disabled state automatically will be enabled after a certain time. If recovery is not enabled, ports have to be disabled and re-enabled for normal STP operation. The condition is also cleared by a system reboot.
<ul style="list-style-type: none"> <li>• <b>Port Error Recovery Timeout</b></li> </ul>	The time that has to pass before a port in the <i>error-disabled</i> state can be enabled. Valid values are between 30 and 86400 seconds (24 hours).

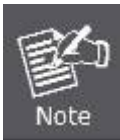

The **Industrial Managed Switch** implements the Rapid Spanning Protocol as the default spanning tree protocol. When selecting “**Compatibles**” mode, the system uses the RSTP (802.1w) to be compatible and to co-work with another STP (802.1D)’s BPDU control packet.

**Buttons**



: Click to apply changes



: Click to undo any changes made locally and revert to previously saved values.

**4.3.4.3 Bridge Status**

This page provides a status overview for all STP bridge instances. The displayed table contains a row for each STP bridge instance, where the column displays the following information: The Bridge Status screen in [Figure 4-3-4-5](#) appears.

STP Bridges						
MSTI	Bridge ID	Root			Topology Flag	Topology Change Last
		ID	Port	Cost		
<u>CIST</u>	80:00-00:30:4F:11:22:55	80:00-00:30:4F:11:22:55	-	0	Steady	-

Auto-refresh  Refresh

**Figure 4-3-4-5:** STP Bridge Status Page Screenshot

The page includes the following fields:

Object	Description
<ul style="list-style-type: none"> <li>• <b>MSTI</b></li> </ul>	The Bridge Instance. This is also a link to the STP Detailed Bridge Status.
<ul style="list-style-type: none"> <li>• <b>Bridge ID</b></li> </ul>	The Bridge ID of this Bridge instance.
<ul style="list-style-type: none"> <li>• <b>Root ID</b></li> </ul>	The Bridge ID of the currently elected root bridge.
<ul style="list-style-type: none"> <li>• <b>Root Port</b></li> </ul>	The switch port currently assigned the <i>root</i> port role.
<ul style="list-style-type: none"> <li>• <b>Root Cost</b></li> </ul>	Root Path Cost. For the Root Bridge this is zero. For all other Bridges, it is the sum of the Port Path Costs on the least cost path to the Root Bridge.
<ul style="list-style-type: none"> <li>• <b>Topology Flag</b></li> </ul>	The current state of the Topology Change Flag for this Bridge instance.

• <b>Topology Change Last</b>	The time since last Topology Change occurred.
-------------------------------	---

**Buttons**

Auto-refresh  Check this box to refresh the page automatically. Automatic refresh occurs every 3 seconds.

: Click to refresh the page immediately.

**4.3.4.4 CIST Port Configuration**

This page allows the user to inspect the current STP CIST port configurations, and possibly change them as well. The CIST Port Configuration screen in [Figure 4-3-4-6](#) appears.

### STP CIST Port Configuration

#### CIST Aggregated Port Configuration

Port	STP Enabled	Path Cost	Priority	Admin Edge	Auto Edge	Restricted		BPDU Guard	Point-to-Point
						Role	TCN		
-	<input type="checkbox"/>	Auto	128	Non-Edge	<input checked="" type="checkbox"/>	<input type="checkbox"/>	<input type="checkbox"/>	<input type="checkbox"/>	Forced True

#### CIST Normal Port Configuration

Port	STP Enabled	Path Cost	Priority	Admin Edge	Auto Edge	Restricted		BPDU Guard	Point-to-Point
						Role	TCN		
*	<input type="checkbox"/>	<All>	<All>	<All>	<input type="checkbox"/>	<input type="checkbox"/>	<input type="checkbox"/>	<input type="checkbox"/>	<All>
1	<input type="checkbox"/>	Auto	128	Non-Edge	<input checked="" type="checkbox"/>	<input type="checkbox"/>	<input type="checkbox"/>	<input type="checkbox"/>	Auto
2	<input type="checkbox"/>	Auto	128	Non-Edge	<input checked="" type="checkbox"/>	<input type="checkbox"/>	<input type="checkbox"/>	<input type="checkbox"/>	Auto
3	<input type="checkbox"/>	Auto	128	Non-Edge	<input checked="" type="checkbox"/>	<input type="checkbox"/>	<input type="checkbox"/>	<input type="checkbox"/>	Auto
4	<input type="checkbox"/>	Auto	128	Non-Edge	<input checked="" type="checkbox"/>	<input type="checkbox"/>	<input type="checkbox"/>	<input type="checkbox"/>	Auto
5	<input type="checkbox"/>	Auto	128	Non-Edge	<input checked="" type="checkbox"/>	<input type="checkbox"/>	<input type="checkbox"/>	<input type="checkbox"/>	Auto
6	<input type="checkbox"/>	Auto	128	Non-Edge	<input checked="" type="checkbox"/>	<input type="checkbox"/>	<input type="checkbox"/>	<input type="checkbox"/>	Auto
7	<input type="checkbox"/>	Auto	128	Non-Edge	<input checked="" type="checkbox"/>	<input type="checkbox"/>	<input type="checkbox"/>	<input type="checkbox"/>	Auto
8	<input type="checkbox"/>	Auto	128	Non-Edge	<input checked="" type="checkbox"/>	<input type="checkbox"/>	<input type="checkbox"/>	<input type="checkbox"/>	Auto

**Figure 4-3-4-6 : STP CIST Port Configuration Page Screenshot**

The page includes the following fields:

Object	Description
• <b>Port</b>	The switch port number of the logical STP port.
• <b>STP Enabled</b>	Controls whether RSTP is enabled on this switch port.
• <b>Path Cost</b>	Controls the path cost incurred by the port. The <b>Auto</b> setting will set the path cost as appropriate by the physical link speed, using the 802.1D recommended values. Using the <b>Specific</b> setting, a user-defined value can be entered. The

	<p>path cost is used when establishing the active topology of the network. Lower path cost ports are chosen as forwarding ports in favor of higher path cost ports. Valid values are in the range 1 to 200000000.</p>
<ul style="list-style-type: none"> <li>• <b>Priority</b></li> </ul>	<p>Controls the port priority. This can be used to control priority of ports having identical port cost. (See above).</p> <p>Default: <b>128</b></p> <p>Range: 0-240, in steps of 16</p>
<ul style="list-style-type: none"> <li>• <b>AdminEdge</b></li> </ul>	<p>Controls whether the operEdge flag should start as being set or cleared. (The initial operEdge state when a port is initialized).</p>
<ul style="list-style-type: none"> <li>• <b>AutoEdge</b></li> </ul>	<p>Controls whether the bridge should enable automatic edge detection on the bridge port. This allows operEdge to be derived from whether BPDU's are received on the port or not.</p>
<ul style="list-style-type: none"> <li>• <b>Restricted Role</b></li> </ul>	<p>If enabled, causes the port not to be selected as Root Port for the CIST or any MSTI, even if it has the best spanning tree priority vector. Such a port will be selected as an Alternate Port after the Root Port has been selected. If set, it can cause lack of spanning tree connectivity. It can be set by a network administrator to prevent bridges external to a core region of the network influence the spanning tree active topology, possibly because those bridges are not under the full control of the administrator. This feature is also known as <b>Root Guard</b>.</p>
<ul style="list-style-type: none"> <li>• <b>Restricted TCN</b></li> </ul>	<p>If enabled, causes the port not to propagate received topology change notifications and topology changes to other ports. If set it can cause temporary loss of connectivity after changes in a spanning tree's active topology as a result of persistently incorrect learned station location information. It is set by a network administrator to prevent bridges external to a core region of the network, causing address flushing in that region, possibly because those bridges are not under the full control of the administrator or the physical link state of the attached LANs transits frequently.</p>
<ul style="list-style-type: none"> <li>• <b>BPDU Guard</b></li> </ul>	<p>If enabled, causes the port to disable itself upon receiving valid BPDU's. Contrary to the similar bridge setting, the port <b>Edge</b> status does not effect this setting. A port entering error-disabled state due to this setting is subject to the bridge Port Error Recovery setting as well.</p>
<ul style="list-style-type: none"> <li>• <b>Point-to-point</b></li> </ul>	<p>Controls whether the port connects to a point-to-point LAN rather than a shared medium. This can be automatically determined, or forced either true or false. Transitions to the forwarding state is faster for point-to-point LANs than for shared media.</p>

**Buttons**

 : Click to apply changes

 : Click to undo any changes made locally and revert to previously saved values.

By default, the system automatically detects the speed and duplex mode used on each port, and configures the path cost according to the values shown below. Path cost "0" is used to indicate auto-configuration mode. When the short path cost method is selected and the default path cost recommended by the IEEE 802.1w standard exceeds 65,535, the default is set to 65,535.

Port Type	IEEE 802.1D-1998	IEEE 802.1w-2001
<b>Ethernet</b>	50-600	200,000-20,000,000
<b>Fast Ethernet</b>	10-60	20,000-2,000,000
<b>Gigabit Ethernet</b>	3-10	2,000-200,000

Table 4-3-4-1: Recommended STP Path Cost Range

Port Type	Link Type	IEEE 802.1D-1998	IEEE 802.1w-2001
<b>Ethernet</b>	Half Duplex	100	2,000,000
	Full Duplex	95	1,999,999
	Trunk	90	1,000,000
<b>Fast Ethernet</b>	Half Duplex	19	200,000
	Full Duplex	18	100,000
	Trunk	15	50,000
<b>Gigabit Ethernet</b>	Full Duplex	4	10,000
	Trunk	3	5,000

Table 4-3-4-2: Recommended STP Path Costs

Port Type	Link Type	IEEE 802.1w-2001
<b>Ethernet</b>	Half Duplex	2,000,000
	Full Duplex	1,000,000
	Trunk	500,000
<b>Fast Ethernet</b>	Half Duplex	200,000
	Full Duplex	100,000
	Trunk	50,000
<b>Gigabit Ethernet</b>	Full Duplex	10,000
	Trunk	5,000

Table 4-3-4-3: Default STP Path Costs



### 4.3.4.5 MSTI Priorities

This page allows the user to inspect the current STP MSTI bridge instance priority configurations, and possibly change them as well. The MSTI Priority screen in [Figure 4-3-4-7](#) appears.

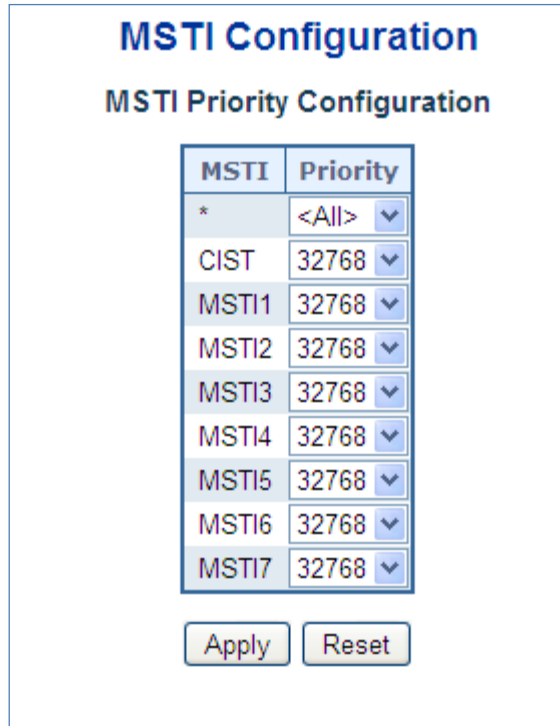



Figure 4-3-4-7: MSTI Priority Page Screenshot

The page includes the following fields:

Object	Description
<ul style="list-style-type: none"> <li><b>MSTI</b></li> </ul>	The bridge instance. The CIST is the default instance, which is always active.
<ul style="list-style-type: none"> <li><b>Priority</b></li> </ul>	Controls the bridge priority. Lower numerical values have better priority. The bridge priority plus the MSTI instance number, concatenated with the 6-byte MAC address of the switch forms a Bridge Identifier.

#### Buttons

 : Click to apply changes

 : Click to undo any changes made locally and revert to previously saved values.

### 4.3.4.6 MSTI Configuration

This page allows the user to inspect the current STP MSTI bridge instance priority configurations, and possibly change them as well. The MSTI Configuration screen in [Figure 4-3-4-8](#) appears.

## MSTI Configuration

Add VLANs separated by spaces or comma.

Unmapped VLANs are mapped to the CIST. (The default bridge instance).

### Configuration Identification

Configuration Name	00-30-4f-11-22-33
Configuration Revision	0

### MSTI Mapping

MSTI	VLANs Mapped	
MSTI1		↑ ↓
MSTI2		↑ ↓
MSTI3		↑ ↓
MSTI4		↑ ↓
MSTI5		↑ ↓
MSTI6		↑ ↓
MSTI7		↑ ↓

**Figure 4-3-4-8:** MSTI Configuration Page Screenshot

The page includes the following fields:

#### Configuration Identification

Object	Description
<ul style="list-style-type: none"> <li><b>Configuration Name</b></li> </ul>	The name identifying the VLAN to MSTI mapping. Bridges must share the name and revision (see below), as well as the VLAN-to-MSTI mapping configuration in order to share spanning trees for MSTI's. (Intra-region). The name is at most 32 characters.
<ul style="list-style-type: none"> <li><b>Configuration Revision</b></li> </ul>	The revision of the MSTI configuration named above. This must be an integer between 0 and 65535.

## MSTI Mapping

Object	Description
<ul style="list-style-type: none"> <li>• <b>MSTI</b></li> </ul>	The bridge instance. The CIST is not available for explicit mapping, as it will receive the VLANs not explicitly mapped.
<ul style="list-style-type: none"> <li>• <b>VLANs Mapped</b></li> </ul>	The list of VLAN's mapped to the MSTI. The VLANs must be separated with comma and/or space. A VLAN can only be mapped to <i>one</i> MSTI. A unused MSTI should just be left empty. (I.e. not having any VLANs mapped to it.)

### Buttons

: Click to apply changes

: Click to undo any changes made locally and revert to previously saved values.

### 4.3.4.7 MSTI Ports Configuration

This page allows the user to inspect the current STP MSTI port configurations, and possibly change them as well. A MSTI port is a virtual port, which is instantiated separately for each active CIST (physical) port for each MSTI instance configured and applicable for the port. The MSTI instance must be selected before displaying actual MSTI port configuration options.

This page contains MSTI port settings for physical and aggregated ports. The aggregation settings are global. The MSTI Port Configuration screen in [Figure 4-3-4-9](#) & [Figure 4-3-4-10](#) appears.



Figure 4-3-4-9 : MSTI Port Configuration Page Screenshot

The page includes the following fields:

### MSTI Port Configuration

Object	Description
<ul style="list-style-type: none"> <li>• <b>Select MSTI</b></li> </ul>	Select the bridge instance and set more detail configuration.

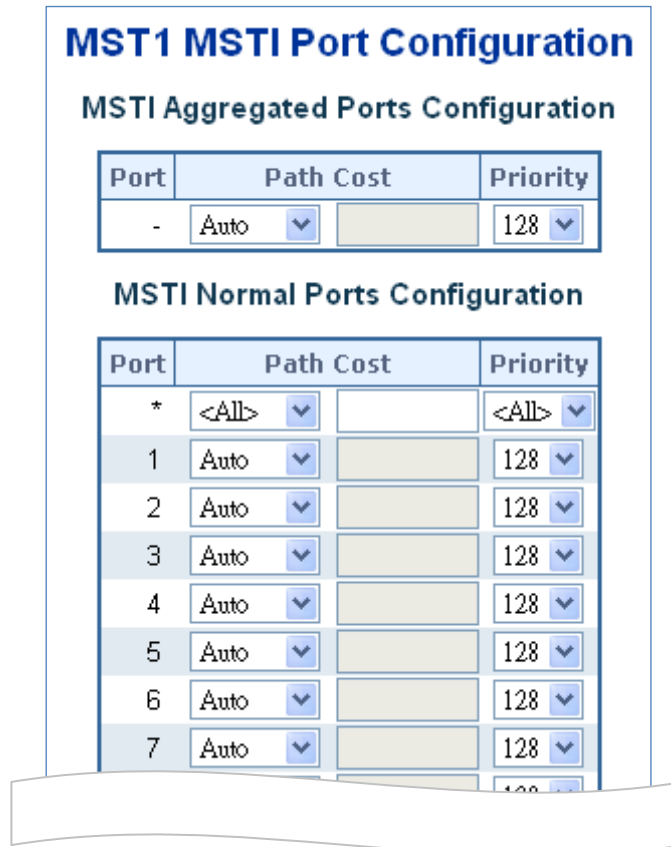

Figure 4-3-4-10 : MST1 MSTI Port Configuration Page Screenshot

The page includes the following fields:

### MSTx MSTI Port Configuration

Object	Description
<ul style="list-style-type: none"> <li>• Port</li> </ul>	The switch port number of the corresponding STP CIST (and MSTI) port.
<ul style="list-style-type: none"> <li>• Path Cost</li> </ul>	Controls the path cost incurred by the port. The Auto setting will set the path cost as appropriate by the physical link speed, using the 802.1D recommended values. Using the Specific setting, a user-defined value can be entered. The path cost is used when establishing the active topology of the network. Lower path cost ports are chosen as forwarding ports in favor of higher path cost ports. Valid values are in the range 1 to 200000000.
<ul style="list-style-type: none"> <li>• Priority</li> </ul>	Controls the port priority. This can be used to control priority of ports having identical port cost.

### Buttons

**Get** : Click to set MSTx configuration

**Apply** : Click to apply changes

**Reset** : Click to undo any changes made locally and revert to previously saved values.

#### 4.3.4.8 Port Status

This page displays the STP CIST port status for port physical ports in the currently selected switch.

The STP Port Status screen in [Figure 4-3-4-11](#) appears.

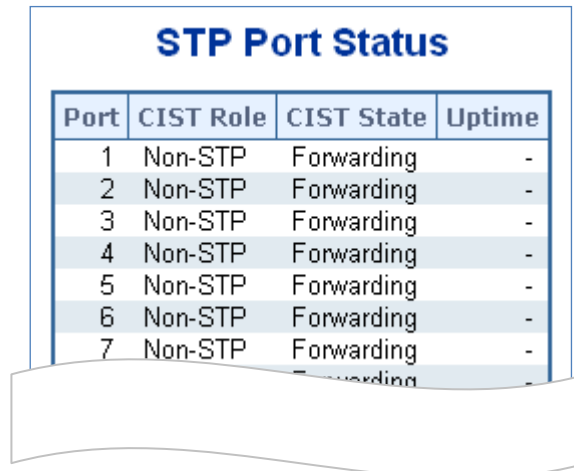

Port	CIST Role	CIST State	Uptime
1	Non-STP	Forwarding	-
2	Non-STP	Forwarding	-
3	Non-STP	Forwarding	-
4	Non-STP	Forwarding	-
5	Non-STP	Forwarding	-
6	Non-STP	Forwarding	-
7	Non-STP	Forwarding	-

**Figure 4-3-4-11:** STP Port Status Page Screenshot

The page includes the following fields:

Object	Description
<ul style="list-style-type: none"> <li>• <b>Port</b></li> </ul>	The switch port number of the logical STP port.
<ul style="list-style-type: none"> <li>• <b>CIST Role</b></li> </ul>	<p>The current STP port role of the ICST port. The port role can be one of the following values:</p> <ul style="list-style-type: none"> <li>■ AlternatePort</li> <li>■ BackupPort</li> <li>■ RootPort</li> <li>■ DesignatedPort</li> <li>■ Disable</li> </ul>
<ul style="list-style-type: none"> <li>• <b>CIST State</b></li> </ul>	<p>The current STP port state of the CIST port . The port state can be one of the following values:</p> <ul style="list-style-type: none"> <li>■ Disabled</li> <li>■ Learning</li> <li>■ Forwarding</li> </ul>
<ul style="list-style-type: none"> <li>• <b>Uptime</b></li> </ul>	The time since the bridge port was last initialized.

#### Buttons

: Click to refresh the page immediately.

Auto-refresh  : Check this box to refresh the page automatically. Automatic refresh occurs every 3 seconds

### 4.3.4.9 Port Statistics

This page displays the STP port statistics counters for port physical ports in the currently selected switch.

The STP Port Statistics screen in [Figure 4-3-4-12](#) appears.

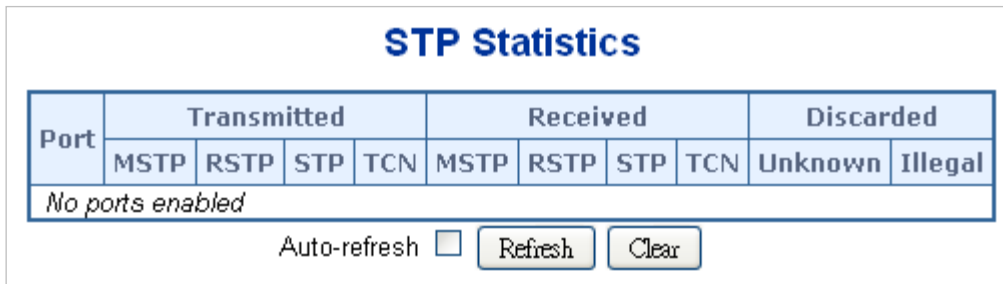

**Figure 4-3-4-12:** STP Statistics Page Screenshot

The page includes the following fields:

Object	Description
• <b>Port</b>	The switch port number of the logical RSTP port.
• <b>MSTP</b>	The number of MSTP Configuration BPDU's received/transmitted on the port.
• <b>RSTP</b>	The number of RSTP Configuration BPDU's received/transmitted on the port.
• <b>STP</b>	The number of legacy STP Configuration BPDU's received/transmitted on the port.
• <b>TCN</b>	The number of (legacy) Topology Change Notification BPDU's received/transmitted on the port.
• <b>Discarded Unknown</b>	The number of unknown Spanning Tree BPDU's received (and discarded) on the port.
• <b>Discarded Illegal</b>	The number of illegal Spanning Tree BPDU's received (and discarded) on the port.

#### Buttons

Auto-refresh : Automatic refresh occurs every 3 seconds.

Refresh: Click to refresh the page immediately.

Clear: Clears the counters for all ports.

## 4.3.5 Multicast

### 4.3.5.1 IGMP Snooping

The **Internet Group Management Protocol (IGMP)** lets host and routers share information about multicast groups memberships. IGMP snooping is a switch feature that monitors the exchange of IGMP messages and copies them to the CPU for feature processing. The overall purpose of IGMP Snooping is to limit the forwarding of multicast frames to only ports that are a member of the multicast group.

#### About the Internet Group Management Protocol (IGMP) Snooping

Computers and network devices that want to receive multicast transmissions need to inform nearby routers that they will become members of a multicast group. The **Internet Group Management Protocol (IGMP)** is used to communicate this information. IGMP is also used to periodically check the multicast group for members that are no longer active. In the case where there is more than one multicast router on a sub network, one router is elected as the 'queried'. This router then keeps track of the membership of the multicast groups that have active members. The information received from IGMP is then used to determine if multicast packets should be forwarded to a given sub network or not. The router can check, using IGMP, to see if there is at least one member of a multicast group on a given subnet work. If there are no members on a sub network, packets will not be forwarded to that sub network.

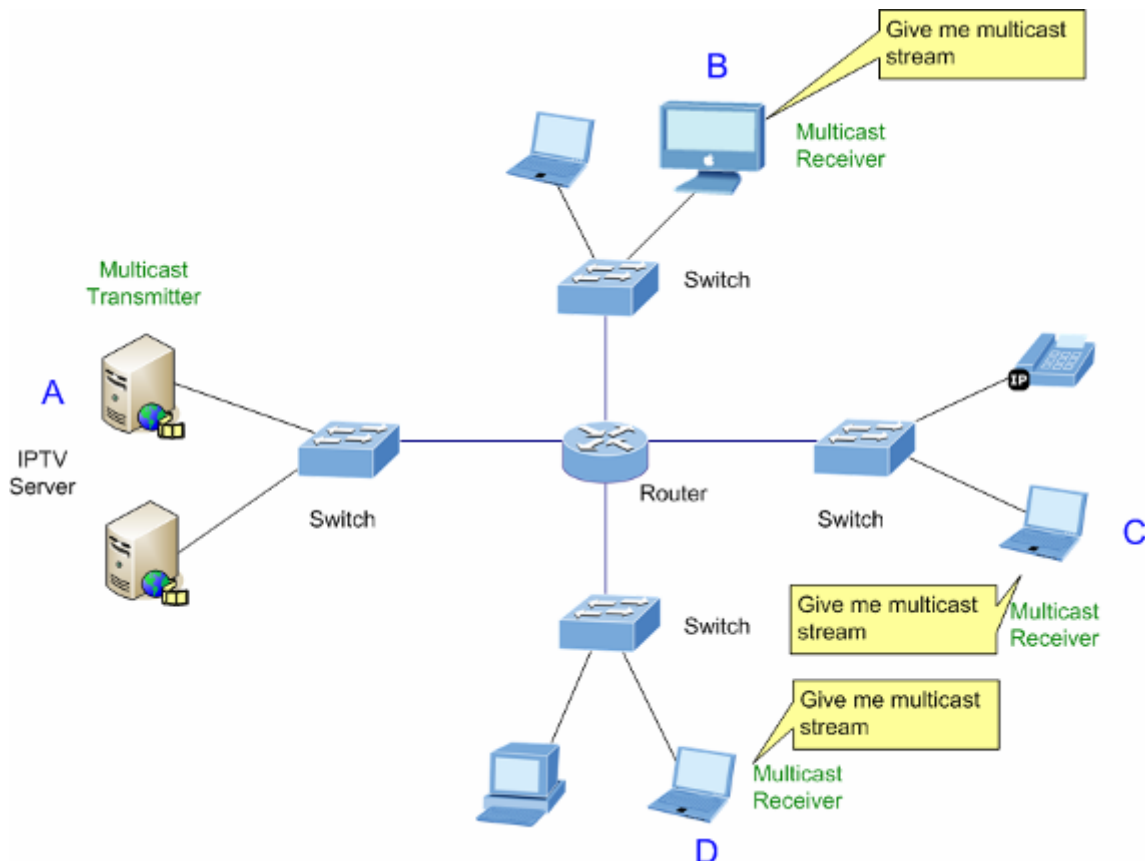

Figure 4-3-5-1: Multicast Service

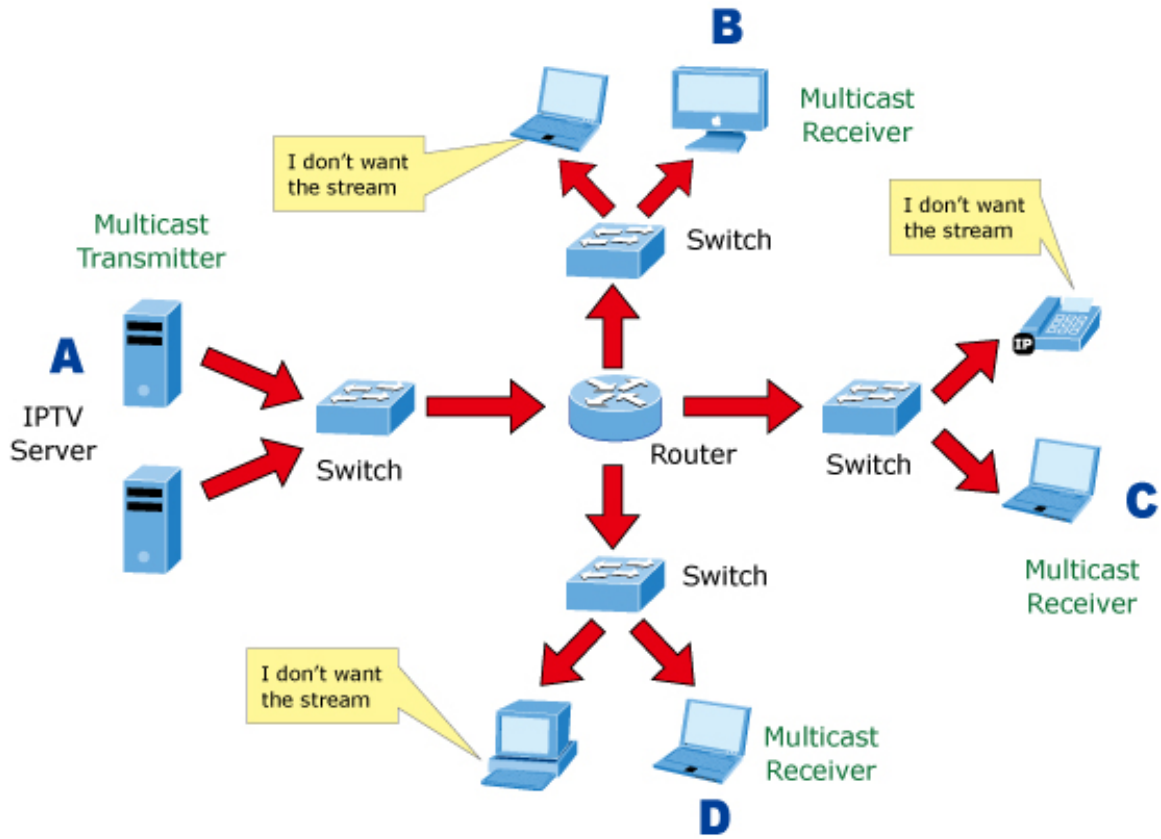

Figure 4-3-5-2: Multicast Flooding

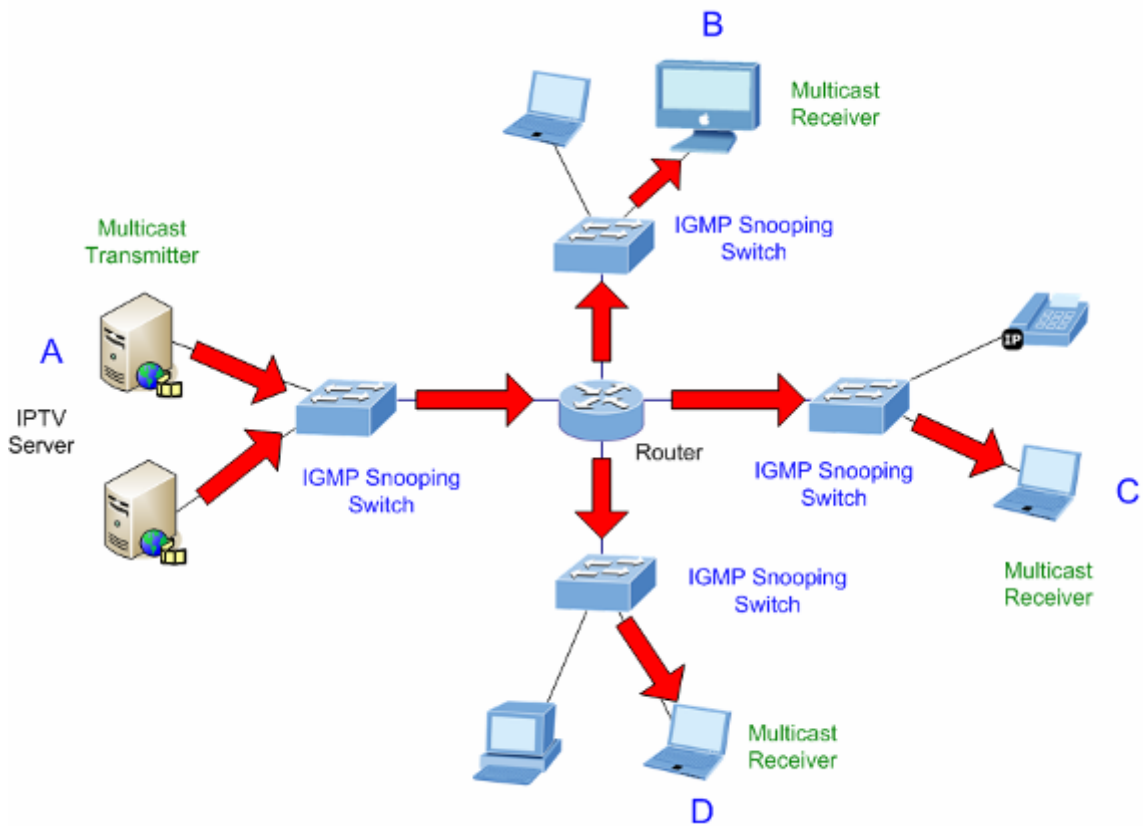

Figure 4-3-5-3: IGMP Snooping Multicast Stream Control



**IGMP Versions 1 and 2**

Multicast groups allow members to join or leave at any time. IGMP provides the method for members and multicast routers to communicate when joining or leaving a multicast group. IGMP version 1 is defined in RFC 1112. It has a fixed packet size and no optional data. The format of an IGMP packet is shown below:

**IGMP Message Format**

Octets

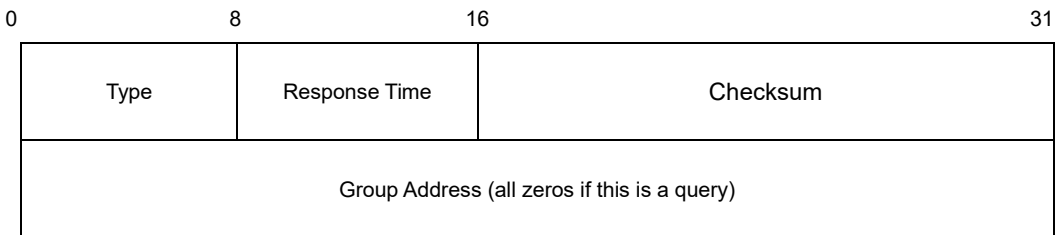

The IGMP Type codes are shown below:

Type	Meaning
<b>0x11</b>	Membership Query (if Group Address is 0.0.0.0)
<b>0x11</b>	Specific Group Membership Query (if Group Address is Present)
<b>0x16</b>	<b>Membership Report (version 2)</b>
<b>0x17</b>	<b>Leave a Group (version 2)</b>
<b>0x12</b>	<b>Membership Report (version 1)</b>

IGMP packets enable multicast routers to keep track of the membership of multicast groups, on their respective sub networks.

The following outlines what is communicated between a multicast router and a multicast group member using IGMP.

A host sends an IGMP “**report**” to join a group

A host will never send a report when it wants to leave a group (for version 1).

A host will send a “**leave**” report when it wants to leave a group (for version 2).

Multicast routers send IGMP queries (to the all-hosts group address: 224.0.0.1) periodically to see whether any group members exist on their sub networks. If there is no response from a particular group, the router assumes that there are no group members on the network.

The Time-to-Live (TTL) field of query messages is set to 1 so that the queries will not be forwarded to other sub networks.

IGMP version 2 introduces some enhancements such as a method to elect a multicast queried for each LAN, an explicit leave message, and query messages that are specific to a given group.

The states a computer will go through to join or to leave a multicast group are shown below:

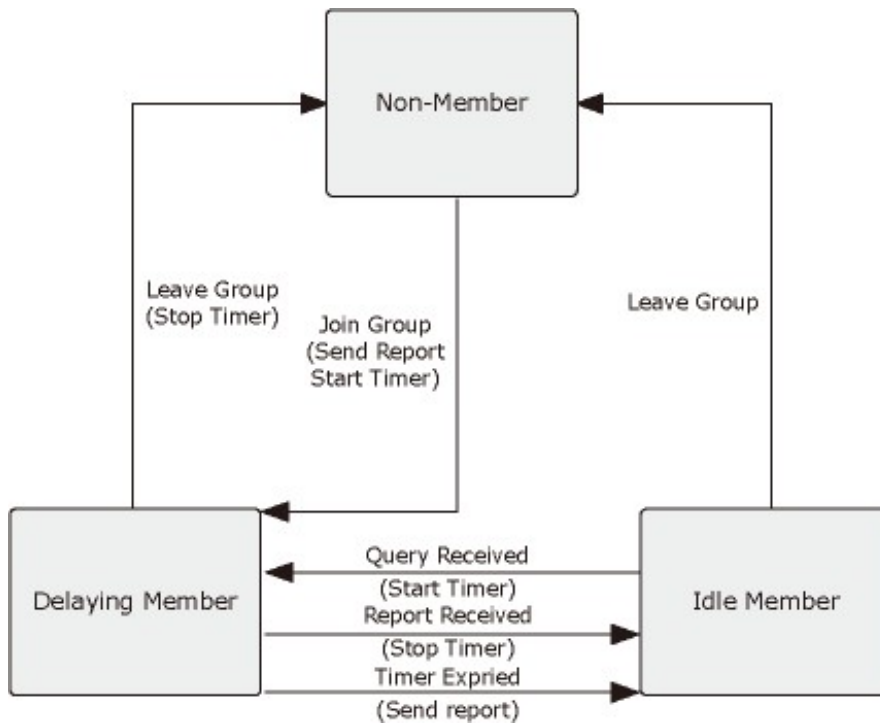
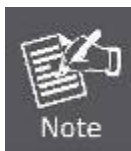

Figure 4-3-5-4: IGMP State Transitions

■ **IGMP Querier –**

A router, or multicast-enabled switch, can periodically ask their hosts if they want to receive multicast traffic. If there is more than one router/switch on the LAN performing IP multicasting, one of these devices is elected “**querier**” and assumes the role of querying the LAN for group members. It then propagates the service requests on to any upstream multicast switch/router to ensure that it will continue to receive the multicast service.



Multicast routers use this information, along with a multicast routing protocol such as DVMRP or PIM, to support IP multicasting across the Internet.

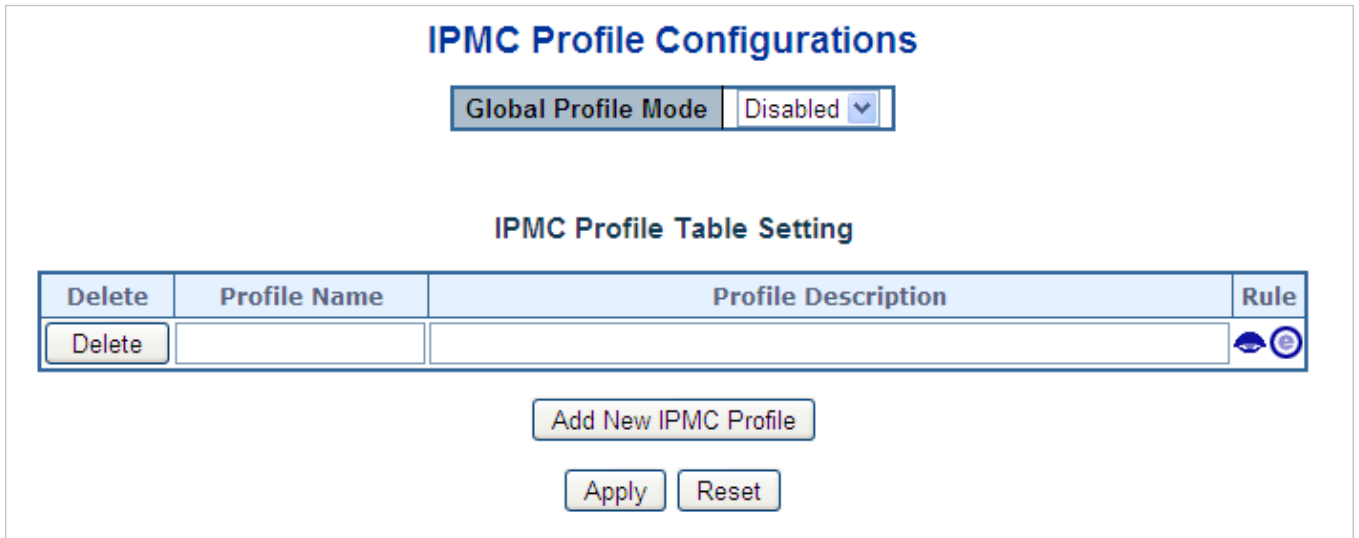

**4.3.5.2 Profile Table**

This page provides IPMC Profile related configurations. The IPMC profile is used to deploy the access control on IP multicast streams. It is allowed to create at maximum 64 Profiles with at maximum 128 corresponding rules for each. The Profile Table screen in Figure 4-3-5-5 appears.

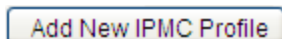

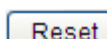

**Figure 4-3-5-5:** IPMC Profile Configuration Page

The page includes the following fields:

Object	Description
<ul style="list-style-type: none"> <li><b>Global Profile Mode</b></li> </ul>	Enable/Disable the Global IPMC Profile. System starts to do filtering based on profile settings only when the global profile mode is enabled.
<ul style="list-style-type: none"> <li><b>Delete</b></li> </ul>	Check to delete the entry. The designated entry will be deleted during the next save.
<ul style="list-style-type: none"> <li><b>Profile Name</b></li> </ul>	The name used for indexing the profile table. Each entry has the unique name which is composed of at maximum 16 alphabetic and numeric characters. At least one alphabet must be present.
<ul style="list-style-type: none"> <li><b>Profile Description</b></li> </ul>	Additional description, which is composed of at maximum 64 alphabetic and numeric characters, about the profile. No blank or space characters are permitted as part of description. Use "_" or "-" to separate the description sentence.
<ul style="list-style-type: none"> <li><b>Rule</b></li> </ul>	When the profile is created, click the edit button to enter the rule setting page of the designated profile. Summary about the designated profile will be shown by clicking the view button. You can manage or inspect the rules of the designated profile by using the following buttons:  : List the rules associated with the designated profile.  : Adjust the rules associated with the designated profile.

**Buttons**

-  : Click to add new IPMC profile. Specify the name and configure the new entry. Click "Save".
-  : Click to apply changes
-  : Click to undo any changes made locally and revert to previously saved values.

### 4.3.5.3 Address Entry

This page provides address range settings used in IPMC profile. The address entry is used to specify the address range that will be associated with IPMC Profile. It is allowed to create at maximum 128 address entries in the system. The Profile Table screen in Figure 4-3-5-6 appears.

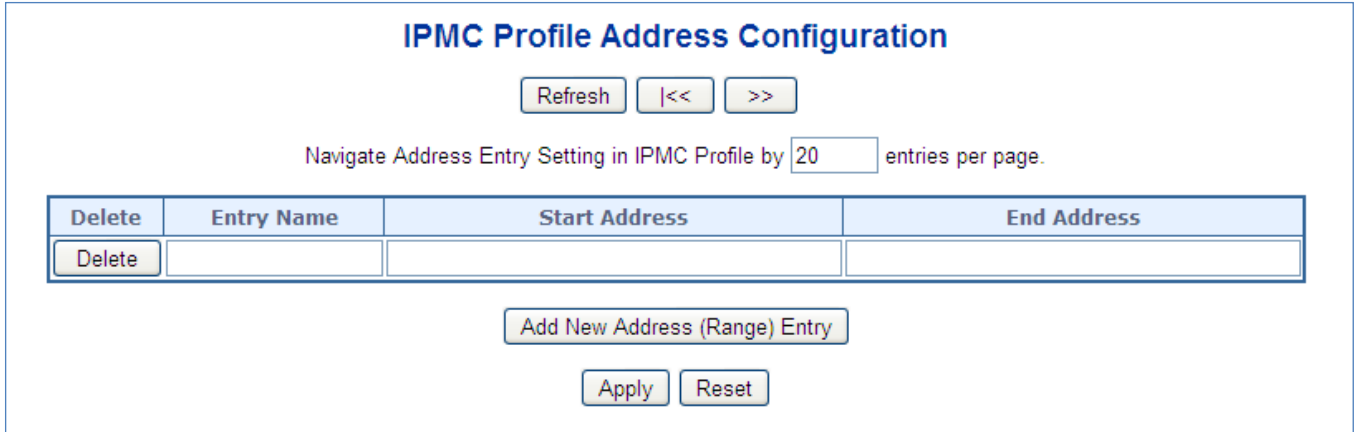

Figure 4-3-5-6: IPMC Profile Address Configuration Page

The page includes the following fields:

Object	Description
<ul style="list-style-type: none"> <li>• <b>Delete</b></li> </ul>	<p>Check to delete the entry.</p> <p>The designated entry will be deleted during the next save.</p>
<ul style="list-style-type: none"> <li>• <b>Entry Name</b></li> </ul>	<p>The name used for indexing the address entry table.</p> <p>Each entry has the unique name which is composed of at maximum 16 alphabetic and numeric characters. At least one alphabet must be present.</p>
<ul style="list-style-type: none"> <li>• <b>Start Address</b></li> </ul>	<p>The starting IPv4/IPv6 Multicast Group Address that will be used as an address range.</p>
<ul style="list-style-type: none"> <li>• <b>End Address</b></li> </ul>	<p>The ending IPv4/IPv6 Multicast Group Address that will be used as an address range.</p>

#### Buttons

**Add New Address (Range) Entry**: Click to add new address range. Specify the name and configure the addresses. Click "Save".

**Apply**: Click to apply changes

**Reset**: Click to undo any changes made locally and revert to previously saved values.

**Refresh**: Refreshes the displayed table starting from the input fields.

**<<**: Updates the table starting from the first entry in the IPMC Profile Address Configuration.

**>>**: Updates the table, starting with the entry after the last entry currently displayed.

#### 4.3.5.4 IGMP Snooping Configuration

This page provides IGMP Snooping related configuration. The IGMP Snooping Configuration screen in [Figure 4-3-5-7](#) appears.

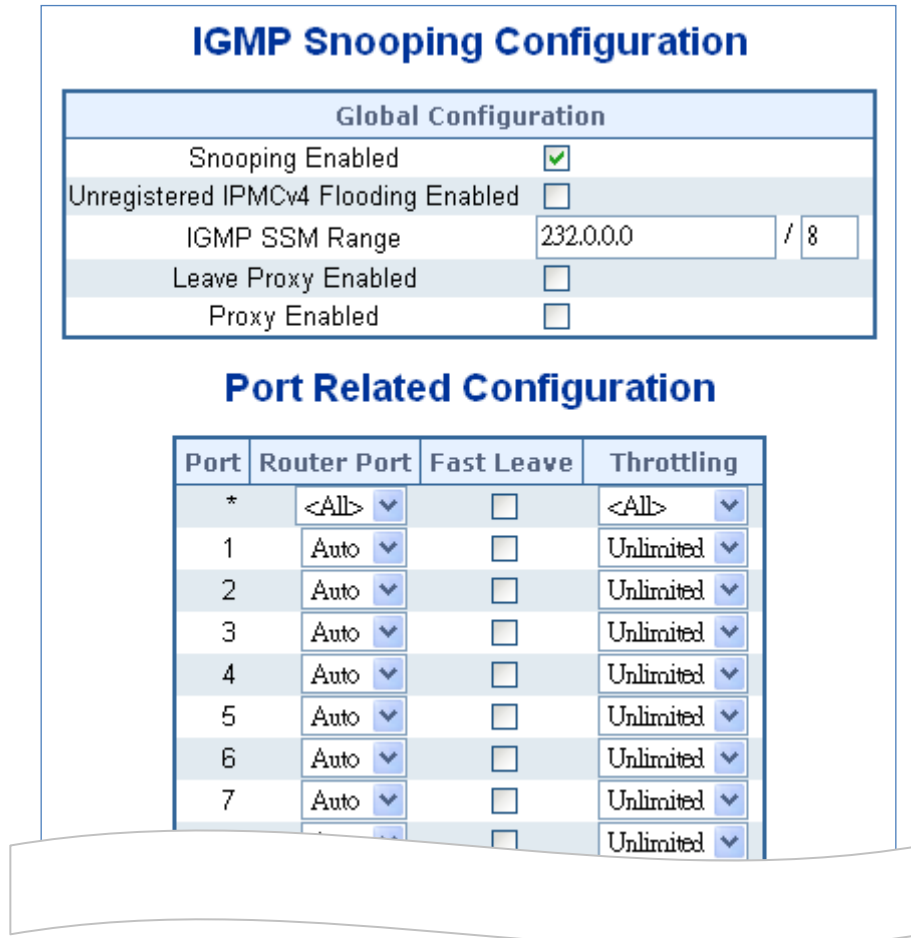



Figure 4-3-5-7: IGMP Snooping Configuration Page Screenshot

The page includes the following fields:

Object	Description
• <b>Snooping Enabled</b>	Enable the Global IGMP Snooping.
• <b>Unregistered IPMCv4 Flooding Enabled</b>	Enable unregistered IPMCv4 traffic flooding. The flooding control takes effect only when IGMP Snooping is enabled. When IGMP Snooping is disabled, unregistered IPMCv4 traffic flooding is always active in spite of this setting.
• <b>IGMP SSM Range</b>	SSM (Source-Specific Multicast) Range allows the SSM-aware hosts and routers run the SSM service model for the groups in the address range.
• <b>Leave Proxy Enable</b>	Enable IGMP Leave Proxy. This feature can be used to avoid forwarding unnecessary leave messages to the router side.
• <b>Proxy Enable</b>	Enable IGMP Proxy. This feature can be used to avoid forwarding unnecessary join and leave messages to the router side.
• <b>Router Port</b>	Specify which ports act as IGMP router ports. A router port is a port on the Ethernet switch that leads towards the Layer 3 multicast device or IGMP querier.

	<p>The Switch forwards IGMP join or leave packets to an IGMP router port.</p> <ul style="list-style-type: none"> <li>■ <b>Auto:</b> Select "Auto" to have the <b>Industrial Managed Switch</b> automatically uses the port as IGMP Router port if the port receives IGMP query packets.</li> <li>■ <b>Fix:</b> The <b>Industrial Managed Switch</b> always uses the specified port as an IGMP Router port. Use this mode when you connect an IGMP multicast server or IP camera which applied with multicast protocol to the port.</li> <li>■ <b>None:</b> The <b>Industrial Managed Switch</b> will not use the specified port as an IGMP Router port. The <b>Industrial Managed Switch</b> will not keep any record of an IGMP router being connected to this port. Use this mode when you connect other IGMP multicast servers directly on the non-querier <b>Industrial Managed Switch</b> and don't want the multicast stream to be flooded by uplinking switch through the port that is connected to the IGMP querier.</li> </ul>
<ul style="list-style-type: none"> <li>• <b>Fast Leave</b></li> </ul>	<p>Enable the fast leave on the port.</p>
<ul style="list-style-type: none"> <li>• <b>Throtting</b></li> </ul>	<p>Enable to limit the number of multicast groups to which a switch port can belong.</p>

**Buttons**

 : Click to apply changes

 : Click to undo any changes made locally and revert to previously saved values.

**4.3.5.5 IGMP Snooping VLAN Configuration**

Each page shows up to 99 entries from the VLAN table, default being 20, selected through the "entries per page" input field. When first visited, the web page will show the first 20 entries from the beginning of the VLAN Table. The first displayed will be the one with the lowest VLAN ID found in the VLAN Table.

The "VLAN" input fields allow the user to select the starting point in the VLAN Table. The IGMP Snooping VLAN Configuration screen in [Figure 4-3-5-8](#) appears.

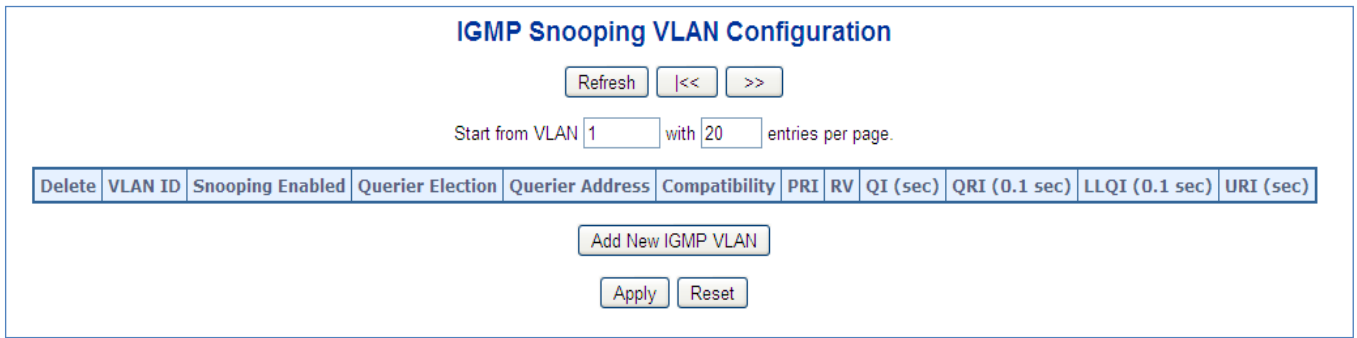

Figure 4-3-5-8: IGMP Snooping VLAN Configuration Page Screenshot

The page includes the following fields:

Object	Description
• <b>Delete</b>	Check to delete the entry. The designated entry will be deleted during the next save.
• <b>VLAN ID</b>	The VLAN ID of the entry.
• <b>IGMP Snooping Enable</b>	Enable the per-VLAN IGMP Snooping. Only up to 32 VLANs can be selected.
• <b>Querier Election</b>	Enable the IGMP Querier election in the VLAN. Disable to act as an IGMP Non-Querier.
• <b>Querier Address</b>	<p>Define the IPv4 address as source address used in IP header for IGMP Querier election.</p> <ul style="list-style-type: none"> <li>■ When the Querier address is not set, system uses IPv4 management address of the IP interface associated with this VLAN.</li> <li>■ When the IPv4 management address is not set, system uses the first available IPv4 management address. Otherwise, system uses a pre-defined value.</li> </ul> <p>By default, this value will be 192.0.2.1</p>
• <b>Compatibility</b>	<p>Compatibility is maintained by hosts and routers taking appropriate actions depending on the versions of IGMP operating on hosts and routers within a network. The allowed selection is <b>IGMP-Auto</b>, <b>Forced IGMPv1</b>, <b>Forced IGMPv2</b>, <b>Forced IGMPv3</b>.</p> <p>Default compatibility value is <b>IGMP-Auto</b>.</p>
• <b>PRI</b>	<p>(PRI) Priority of Interface. It indicates the IGMP control frame priority level generated by the system. These values can be used to prioritize different classes of traffic.</p> <p>The allowed range is <b>0</b> (best effort) to <b>7</b> (highest), default interface priority value is 0</p>
• <b>RV</b>	Robustness Variable. The Robustness Variable allows tuning for the expected packet loss on a network.

	The allowed range is 1 to 255, default robustness variable value is 2.
• <b>QI</b>	Query Interval. The Query Interval is the interval between General Queries sent by the Querier. The allowed range is 1 to 31744 seconds, default query interval is 125 seconds.
• <b>QRI</b>	Query Response Interval. The Max Response Time used to calculate the Max Resp Code inserted into the periodic General Queries.  The allowed range is 0 to 31744 in tenths of seconds, default query response interval is 100 in tenths of seconds (10 seconds).
• <b>LLQI (LMQI for IGMP)</b>	Last Member Query Interval. The Last Member Query Time is the time value represented by the Last Member Query Interval, multiplied by the Last Member Query Count.  The allowed range is 0 to 31744 in tenths of seconds, default last member query interval is 10 in tenths of seconds (1 second).
• <b>URI</b>	Unsolicited Report Interval. The Unsolicited Report Interval is the time between repetitions of a host's initial report of membership in a group.  The allowed range is 0 to 31744 seconds, default unsolicited report interval is 1 second.

**Buttons**

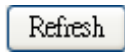
 : Refreshes the displayed table starting from the "VLAN" input fields.

 : Updates the table starting from the first entry in the VLAN Table, i.e. the entry with the lowest VLAN ID.

 : Updates the table, starting with the entry after the last entry currently displayed.

 : Click to add new IGMP VLAN. Specify the VID and configure the new entry.

Click "Save". The specific IGMP VLAN starts working after the corresponding static VLAN is also created.

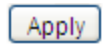
 : Click to apply changes

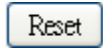
 : Click to undo any changes made locally and revert to previously saved values.

**4.3.5.6 IGMP Snooping Port Group Filtering**

In certain switch applications, the administrator may want to control the multicast services that are available to end users. For example, an IP/TV service based on a specific subscription plan. The IGMP filtering feature fulfills this requirement by restricting access to specified multicast services on a switch port, and IGMP throttling limits the number of simultaneous multicast groups a port can join.

IGMP filtering enables you to assign a profile to a switch port that specifies multicast groups that are permitted or denied on the port. An IGMP filter profile can contain one or more, or a range of multicast addresses; but only one profile can be assigned to a



port. When enabled, IGMP join reports received on the port are checked against the filter profile. If a requested multicast group is permitted, the IGMP join report is forwarded as normal. If a requested multicast group is denied, the IGMP join report is dropped.

IGMP throttling sets a maximum number of multicast groups that a port can join at the same time. When the maximum number of groups is reached on a port, the switch can take one of two actions; either "deny" or "replace". If the action is set to deny, any new IGMP join reports will be dropped. If the action is set to replace, the switch randomly removes an existing group and replaces it with the new multicast group. The IGMP Snooping Port Group Filtering Configuration screen in [Figure 4-3-5-9](#) appears.

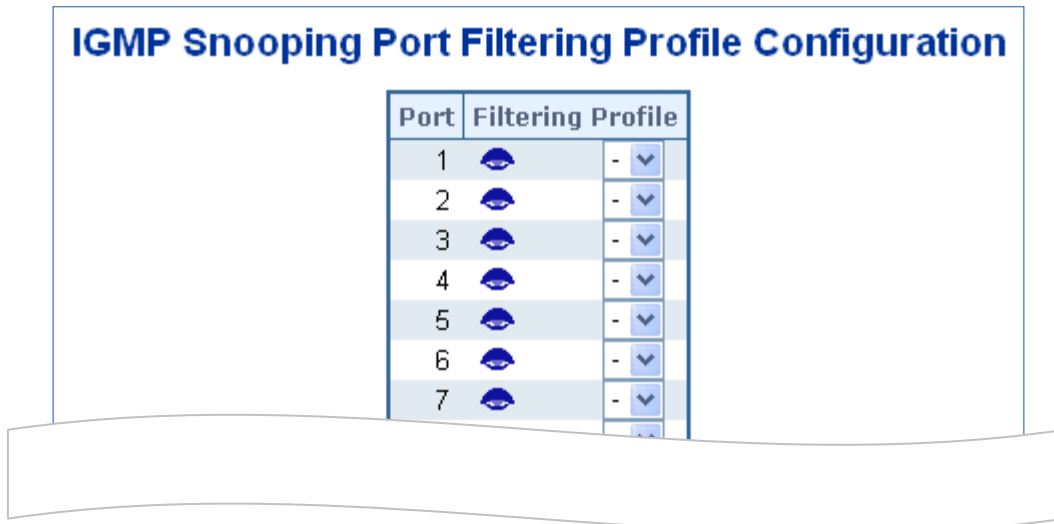



**Figure 4-3-5-9:** IGMP Snooping Port Filtering Profile Configuration Page Screenshot

The page includes the following fields:

Object	Description
<ul style="list-style-type: none"> <li>• <b>Port</b></li> </ul>	The logical port for the settings.
<ul style="list-style-type: none"> <li>• <b>Filtering Profile</b></li> </ul>	Select the IPMC Profile as the filtering condition for the specific port. Summary about the designated profile will be shown by clicking the view button

**Buttons**

 : Click to apply changes

 : Click to undo any changes made locally and revert to previously saved values.

**4.3.5.7 IGMP Snooping Status**

This page provides IGMP Snooping status. The IGMP Snooping Status screen in [Figure 4-3-5-10](#) appears.

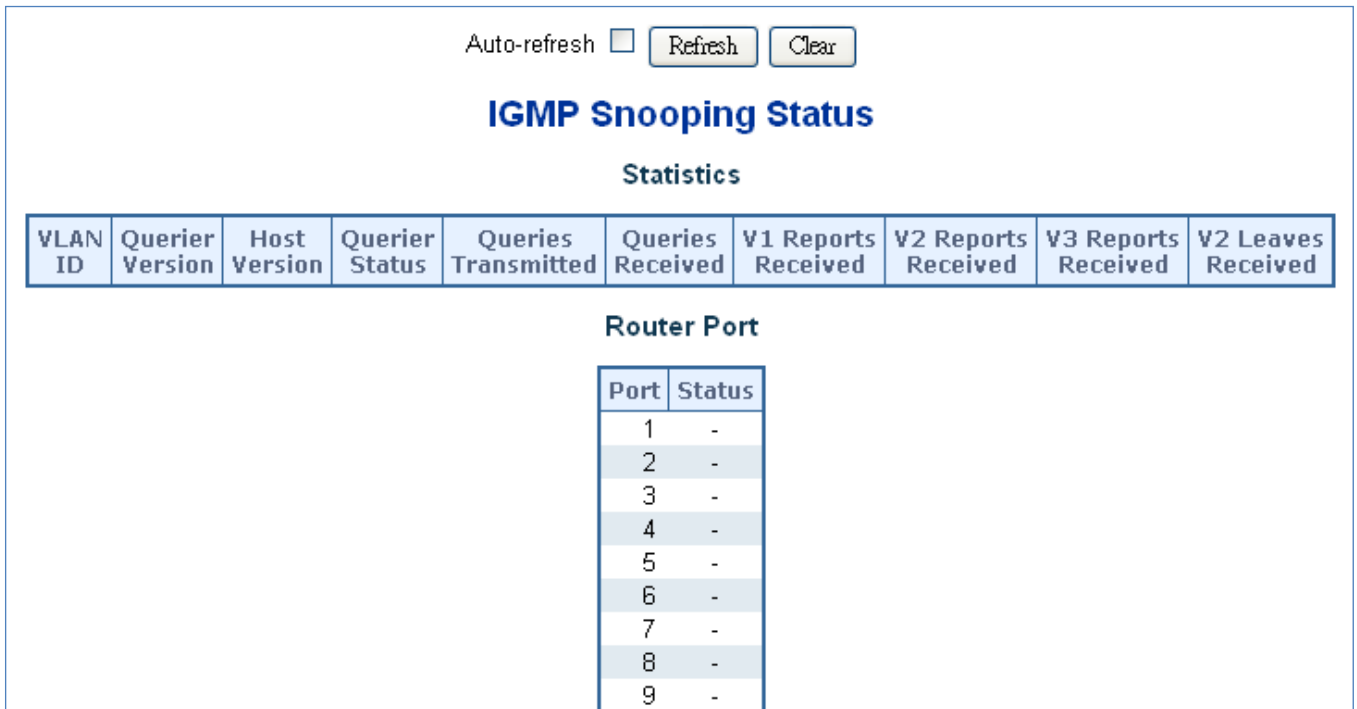

Figure 4-3-5-10: IGMP Snooping Status Page Screenshot

The page includes the following fields:

Object	Description
• <b>VLAN ID</b>	The VLAN ID of the entry.
• <b>Querier Version</b>	Working Querier Version currently.
• <b>Host Version</b>	Working Host Version currently.
• <b>Querier Status</b>	Show the Querier status is "ACTIVE" or "IDLE".
• <b>Querier Transmitted</b>	The number of Transmitted Querier.
• <b>Querier Received</b>	The number of Received Querier.
• <b>V1 Reports Received</b>	The number of Received V1 Reports.
• <b>V2 Reports Received</b>	The number of Received V2 Reports.
• <b>V3 Reports Received</b>	The number of Received V3 Reports.
• <b>V2 Leave Received</b>	The number of Received V2 Leave.
• <b>Router Port</b>	Display which ports act as router ports. A router port is a port on the Ethernet switch that leads towards the Layer 3 multicast device or IGMP querier. Static denotes the specific port is configured to be a router port. Dynamic denotes the specific port is learnt to be a router port. Both denote the specific port is configured or learnt to be a router port.
• <b>Port</b>	Switch port number.
• <b>Status</b>	Indicate whether specific port is a router port or not.

**Buttons**

: Click to refresh the page immediately.

: Clears all Statistics counters.

Auto-refresh  : Automatic refresh occurs every 3 seconds.

**4.3.5.8 IGMP Group Information**

Entries in the IGMP Group Table are shown on this Page. The IGMP Group Table is sorted first by VLAN ID, and then by group. Each page shows up to 99 entries from the IGMP Group table, default being 20, selected through the "entries per page" input field. When first visited, the web page will show the first 20 entries from the beginning of the IGMP Group Table. The "Start from VLAN", and "group" input fields allow the user to select the starting point in the IGMP Group Table. The IGMP Groups Information screen in [Figure 4-3-5-11](#) appears.

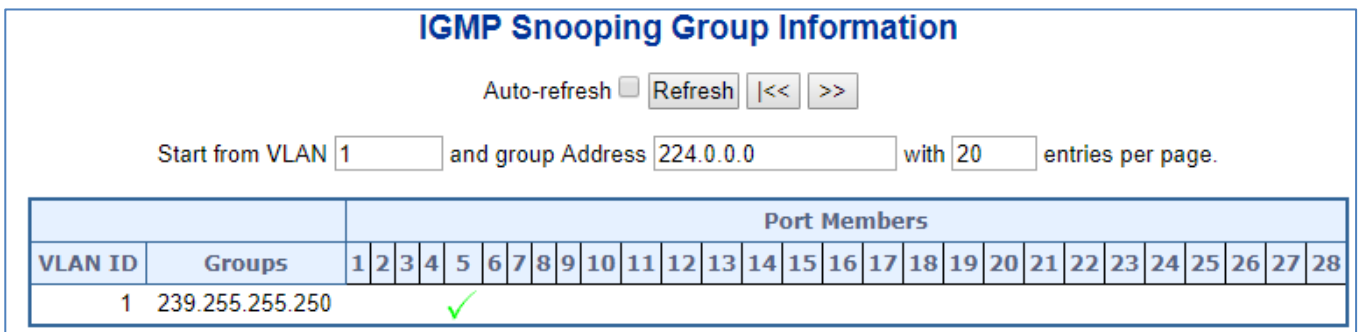

**IGMP Snooping Group Information**

Auto-refresh

Start from VLAN  and group Address  with  entries per page.

VLAN ID	Groups	Port Members																											
		1	2	3	4	5	6	7	8	9	10	11	12	13	14	15	16	17	18	19	20	21	22	23	24	25	26	27	28
1	239.255.255.250					✓																							

**Figure 4-3-5-11: IGMP Snooping Groups Information Page Screenshot**

The page includes the following fields:

Object	Description
• <b>VLAN ID</b>	VLAN ID of the group.
• <b>Groups</b>	Group address of the group displayed.
• <b>Port Members</b>	Ports under this group.

**Buttons**

Auto-refresh  : Automatic refresh occurs every 3 seconds.

: Refreshes the displayed table starting from the input fields.

: Updates the table, starting with the first entry in the IGMP Group Table.

: Updates the table, starting with the entry after the last entry currently displayed.

## 4.3.6 MLD Snooping

### 4.3.6.1 MLD Snooping Configuration

This page provides MLD Snooping related configuration. The MLD Snooping Configuration screen in [Figure 4-3-6-1](#) appears.

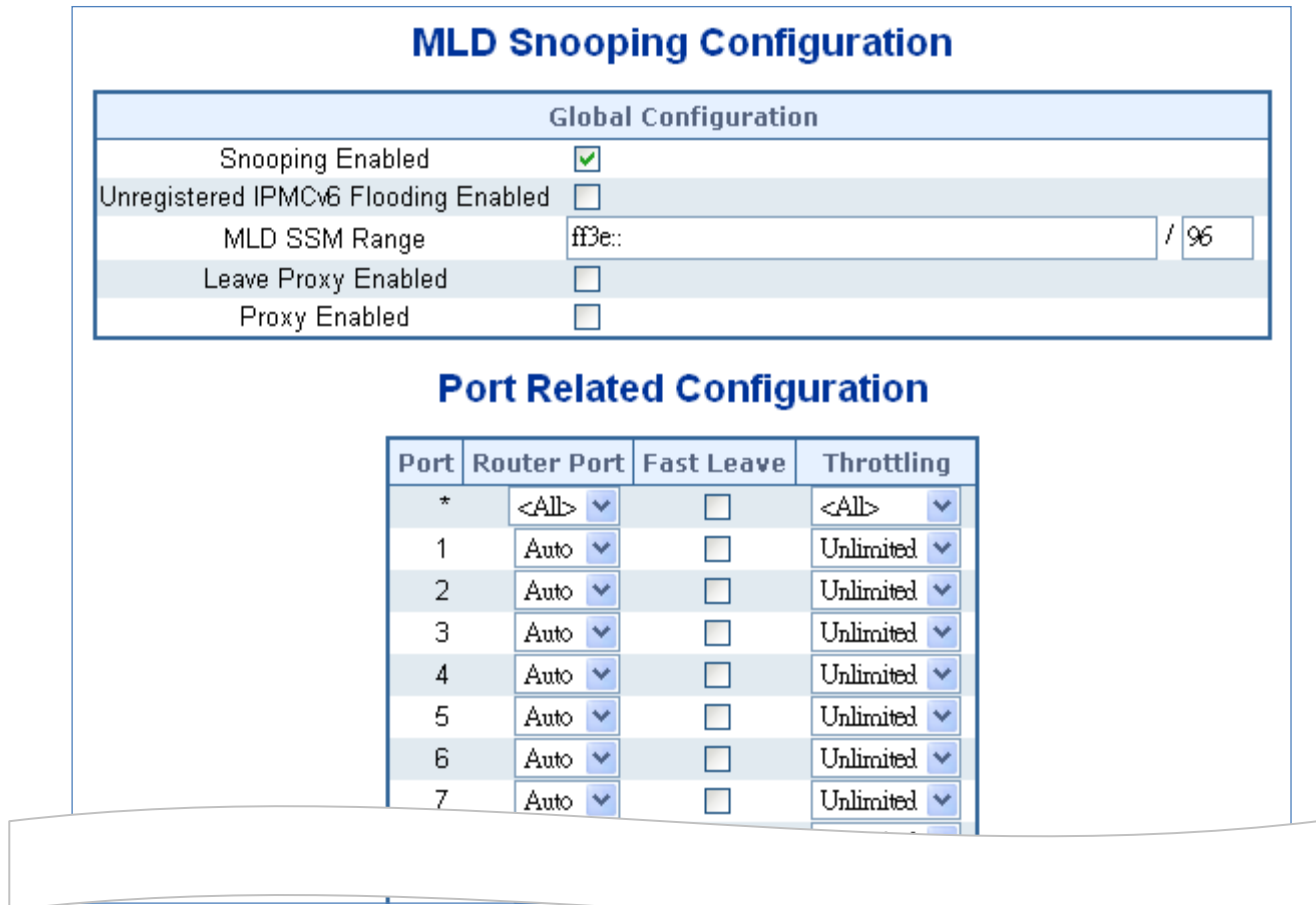

Global Configuration			
Snooping Enabled	<input checked="" type="checkbox"/>		
Unregistered IPMCv6 Flooding Enabled	<input type="checkbox"/>		
MLD SSM Range	ff3e::	/	96
Leave Proxy Enabled	<input type="checkbox"/>		
Proxy Enabled	<input type="checkbox"/>		

Port Related Configuration			
Port	Router Port	Fast Leave	Throttling
*	<All>	<input type="checkbox"/>	<All>
1	Auto	<input type="checkbox"/>	Unlimited
2	Auto	<input type="checkbox"/>	Unlimited
3	Auto	<input type="checkbox"/>	Unlimited
4	Auto	<input type="checkbox"/>	Unlimited
5	Auto	<input type="checkbox"/>	Unlimited
6	Auto	<input type="checkbox"/>	Unlimited
7	Auto	<input type="checkbox"/>	Unlimited

Figure 4-3-6-1: MLD Snooping Configuration Page Screenshot

The page includes the following fields:

Object	Description
• <b>Snooping Enabled</b>	Enable the Global MLD Snooping.
• <b>Unregistered IPMCv6 Flooding enabled</b>	Enable unregistered IPMCv6 traffic flooding. The flooding control takes effect only when MLD Snooping is enabled. When MLD Snooping is disabled, unregistered IPMCv6 traffic flooding is always active in spite of this setting.
• <b>MLD SSM Range</b>	SSM (Source-Specific Multicast) Range allows the SSM-aware hosts and routers run the SSM service model for the groups in the address range.
• <b>Leave Proxy Enable</b>	Enable MLD Leave Proxy. This feature can be used to avoid forwarding unnecessary leave messages to the router side.
• <b>Proxy Enable</b>	Enable MLD Proxy. This feature can be used to avoid forwarding unnecessary

	join and leave messages to the router side.
<ul style="list-style-type: none"> <li>• <b>Router Port</b></li> </ul>	Specify which ports act as router ports. A router port is a port on the Ethernet switch that leads towards the Layer 3 multicast device or MLD querier.  If an aggregation member port is selected as a router port, the whole aggregation will act as a router port. The allowed selection is <b>Auto</b> , <b>Fix</b> , <b>None</b> , default compatibility value is Auto.
<ul style="list-style-type: none"> <li>• <b>Fast Leave</b></li> </ul>	Enable the fast leave on the port.
<ul style="list-style-type: none"> <li>• <b>Throtting</b></li> </ul>	Enable to limit the number of multicast groups to which a switch port can belong.

**Buttons**

 : Click to apply changes

 : Click to undo any changes made locally and revert to previously saved values.

**4.3.6.2 MLD Snooping VLAN Configuration**

Each page shows up to 99 entries from the VLAN table, default being 20, selected through the "entries per page" input field. When first visited, the web page will show the first 20 entries from the beginning of the VLAN Table. The first displayed will be the one with the lowest VLAN ID found in the VLAN Table.

The "VLAN" input fields allow the user to select the starting point in the VLAN Table. The MLD Snooping VLAN Configuration screen in [Figure 4-3-6-2](#) appears.

**MLD Snooping VLAN Configuration**

Start from VLAN  with  entries per page.

VLAN ID	Snooping Enabled	Querier Election	Compatibility	PRI	RV	QI (sec)	QRI (0.1 sec)	LLQI (0.1 sec)	URI (sec)
1	<input checked="" type="checkbox"/>	<input checked="" type="checkbox"/>	MLD-Auto ▾	0 ▾	2	125	100	10	1

**Figure 4-3-6-2: IGMP Snooping VLAN Configuration Page Screenshot**

The page includes the following fields:

Object	Description
<ul style="list-style-type: none"> <li>• <b>Delete</b></li> </ul>	Check to delete the entry. The designated entry will be deleted during the next save.
<ul style="list-style-type: none"> <li>• <b>VLAN ID</b></li> </ul>	The VLAN ID of the entry.
<ul style="list-style-type: none"> <li>• <b>MLD Snooping Enable</b></li> </ul>	Enable the per-VLAN MLD Snooping. Up to 32 VLANs can be selected for MLD Snooping.

<ul style="list-style-type: none"> <li>• <b>Querier Election</b></li> </ul>	Enable to join MLD Querier election in the VLAN. Disable to act as a MLD Non-Querier.
<ul style="list-style-type: none"> <li>• <b>Compatibility</b></li> </ul>	Compatibility is maintained by hosts and routers taking appropriate actions depending on the versions of MLD operating on hosts and routers within a network. The allowed selection is <b>MLD-Auto</b> , <b>Forced MLDv1</b> , <b>Forced MLDv2</b> , default compatibility value is MLD-Auto.
<ul style="list-style-type: none"> <li>• <b>PRI</b></li> </ul>	(PRI) Priority of Interface. It indicates the MLD control frame priority level generated by the system. These values can be used to prioritize different classes of traffic. The allowed range is <b>0</b> (best effort) to <b>7</b> (highest), default interface priority value is 0
<ul style="list-style-type: none"> <li>• <b>RV</b></li> </ul>	Robustness Variable. The Robustness Variable allows tuning for the expected packet loss on a network. The allowed range is <b>1</b> to <b>255</b> , default robustness variable value is <b>2</b> .
<ul style="list-style-type: none"> <li>• <b>QI</b></li> </ul>	Query Interval. The Query Interval is the interval between General Queries sent by the Querier. The allowed range is <b>1</b> to <b>31744</b> seconds, default query interval is 125 seconds.
<ul style="list-style-type: none"> <li>• <b>QRI</b></li> </ul>	Query Response Interval. The Max Response Time used to calculate the Max Resp Code inserted into the periodic General Queries. The allowed range is <b>0</b> to <b>31744</b> in tenths of seconds, default query response interval is 100 in tenths of seconds (10 seconds).
<ul style="list-style-type: none"> <li>• <b>LLQI (LMQI for IGMP)</b></li> </ul>	Last Member Query Interval. The Last Member Query Time is the time value represented by the Last Member Query Interval, multiplied by the Last Member Query Count. The allowed range is <b>0</b> to <b>31744</b> in tenths of seconds, default last member query interval is 10 in tenths of seconds (1 second).
<ul style="list-style-type: none"> <li>• <b>URI</b></li> </ul>	Unsolicited Report Interval. The Unsolicited Report Interval is the time between repetitions of a host's initial report of membership in a group. The allowed range is <b>0</b> to <b>31744</b> seconds, default unsolicited report interval is 1 second.

**Buttons**

**Refresh** : Refreshes the displayed table starting from the "VLAN" input fields.

**<<** : Updates the table starting from the first entry in the VLAN Table, i.e. the entry with the lowest VLAN ID.

**>>** : Updates the table, starting with the entry after the last entry currently displayed.

**Add New MLD VLAN** : Click to add new MLD VLAN. Specify the VID and configure the new entry.

Click "Save". The specific MLD VLAN starts working after the corresponding static VLAN is also created.

**Apply** : Click to apply changes

**Reset** : Click to undo any changes made locally and revert to previously saved values.

### 4.3.6.3 MLD Snooping Port Group Filtering

In certain switch applications, the administrator may want to control the multicast services that are available to end users. For example, an IP/TV service based on a specific subscription plan. The MLD filtering feature fulfills this requirement by restricting access to specified multicast services on a switch port, and MLD throttling limits the number of simultaneous multicast groups a port can join.

MLD filtering enables you to assign a profile to a switch port that specifies multicast groups that are permitted or denied on the port. A MLD filter profile can contain one or more, or a range of multicast addresses; but only one profile can be assigned to a port. When enabled, MLD join reports received on the port are checked against the filter profile. If a requested multicast group is permitted, the MLD join report is forwarded as normal. If a requested multicast group is denied, the MLD join report is dropped.

MLD throttling sets a maximum number of multicast groups that a port can join at the same time. When the maximum number of groups is reached on a port, the switch can take one of two actions; either "deny" or "replace". If the action is set to deny, any new MLD join reports will be dropped. If the action is set to replace, the switch randomly removes an existing group and replaces it with the new multicast group. The MLD Snooping Port Group Filtering Configuration screen in [Figure 4-3-6-3](#) appears.

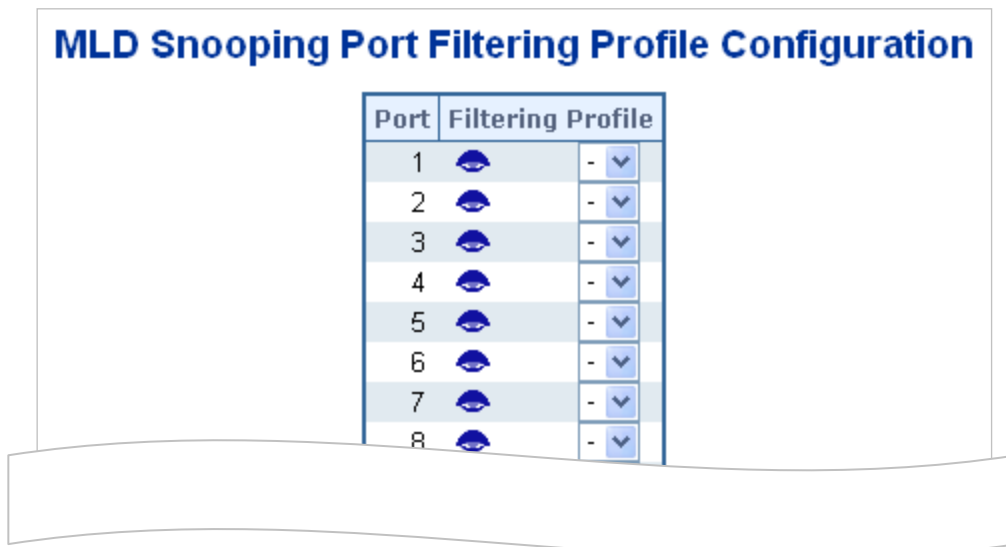

Figure 4-3-6-3: MLD Snooping Port Group Filtering Configuration Page Screenshot

The page includes the following fields:

Object	Description
<ul style="list-style-type: none"> <li>• <b>Port</b></li> </ul>	The logical port for the settings.
<ul style="list-style-type: none"> <li>• <b>Filtering Group</b></li> </ul>	Select the IPMC Profile as the filtering condition for the specific port. Summary about the designated profile will be shown by clicking the view button.

**Buttons**

**Apply** : Click to apply changes

**Reset** : Click to undo any changes made locally and revert to previously saved values.

**4.3.6.4 MLD Snooping Status**

This page provides MLD Snooping status. The IGMP Snooping Status screen in [Figure 4-3-6-4](#) appears.

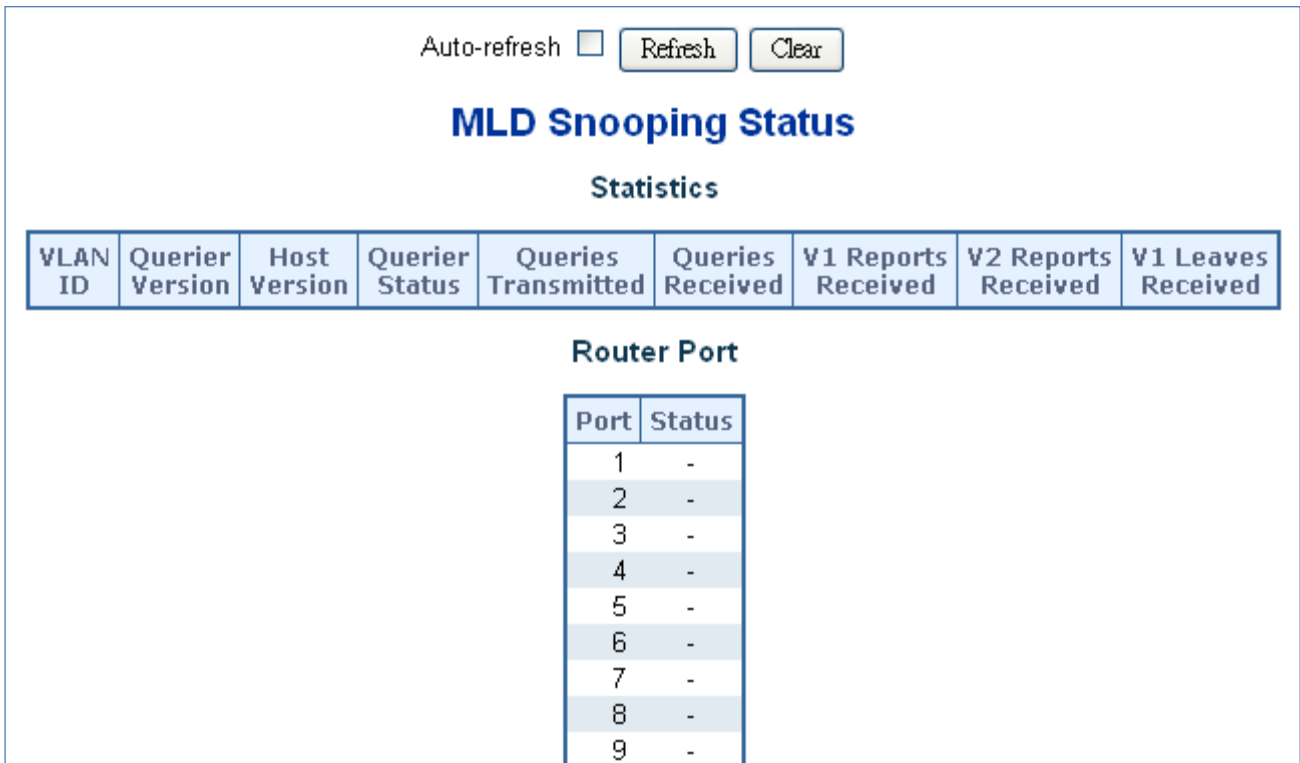

**Figure 4-3-6-4:** MLD Snooping Status Page Screenshot

The page includes the following fields:

Object	Description
• <b>VLAN ID</b>	The VLAN ID of the entry.
• <b>Querier Version</b>	Working Querier Version currently.
• <b>Host Version</b>	Working Host Version currently.
• <b>Querier Status</b>	Shows the Querier status is "ACTIVE" or "IDLE". "DISABLE" denotes the specific interface is administratively disabled.
• <b>Querier Transmitted</b>	The number of Transmitted Querier.
• <b>Querier Received</b>	The number of Received Querier.
• <b>V1 Reports Received</b>	The number of Received V1 Reports.
• <b>V2 Reports Received</b>	The number of Received V2 Reports.
• <b>V1 Leave Received</b>	The number of Received V1 Leaves.



<ul style="list-style-type: none"> <li>• <b>Router Port</b></li> </ul>	<p>Display which ports act as router ports. A router port is a port on the Ethernet switch that leads towards the Layer 3 multicast device or MLD querier.</p> <p>Static denotes the specific port is configured to be a router port.</p> <p>Dynamic denotes the specific port is learnt to be a router port.</p> <p>Both denote the specific port is configured or learnt to be a router port.</p>
<ul style="list-style-type: none"> <li>• <b>Port</b></li> </ul>	<p>Switch port number.</p>
<ul style="list-style-type: none"> <li>• <b>Status</b></li> </ul>	<p>Indicates whether specific port is a router port or not.</p>

**Buttons**

: Click to refresh the page immediately.

: Clears all Statistics counters.

Auto-refresh  : Automatic refresh occurs every 3 seconds.

**4.3.6.5 MLD Group Information**

Entries in the MLD Group Table are shown on this page. The MLD Group Table is sorted first by VLAN ID, and then by group. Each page shows up to 99 entries from the MLD Group table, default being 20, selected through the "entries per page" input field. When first visited, the web page will show the first 20 entries from the beginning of the MLD Group Table.

The "Start from VLAN", and "group" input fields allow the user to select the starting point in the MLD Group Table. The MLD Groups Information screen in [Figure 4-3-6-5](#) appears.

**MLD Snooping Group Information**

Auto-refresh

Start from VLAN  and group Address  with  entries per page.

VLAN ID	Groups	Port Members																											
		1	2	3	4	5	6	7	8	9	10	11	12	13	14	15	16	17	18	19	20	21	22	23	24	25	26	27	28
1	ff02::c					✓																							
1	ff02::fb					✓																							
1	ff02::1:3					✓																							
1	ff02::1:ffbf:ce03					✓																							

**Figure 4-3-6-5: MLD Snooping Groups Information Page Screenshot**

The page includes the following fields:

Object	Description
<ul style="list-style-type: none"> <li>• <b>VLAN ID</b></li> </ul>	VLAN ID of the group.
<ul style="list-style-type: none"> <li>• <b>Groups</b></li> </ul>	Group address of the group displayed.
<ul style="list-style-type: none"> <li>• <b>Port Members</b></li> </ul>	Ports under this group.



**Buttons**

Auto-refresh : Automatic refresh occurs every 3 seconds.

: Click to refresh the page immediately.

: Updates the table, starting with the first entry in the IGMP Group Table.

: Updates the table, starting with the entry after the last entry currently displayed.

**4.3.6.6 MLDv2 Information**

Entries in the MLD SFM Information Table are shown on this page. The MLD SFM (Source-Filtered Multicast) Information Table also contains the SSM (Source-Specific Multicast) information. This table is sorted first by VLAN ID, then by group, and then by Port. Different source addresses belong to the same group are treated as single entry. Each page shows up to 99 entries from the MLD SFM Information table, default being 20, selected through the "entries per page" input field. When first visited, the web Page will show the first 20 entries from the beginning of the MLD SFM Information Table.

The "Start from VLAN", and "group" input fields allow the user to select the starting point in the MLD SFM Information Table. The MLDv2 Information screen in [Figure 4-3-6-6](#) appears.



**Figure 4-3-6-6:** MLD SSM Information Page Screenshot

The page includes the following fields:

Object	Description
• <b>VLAN ID</b>	VLAN ID of the group.
• <b>Group</b>	Group address of the group displayed.
• <b>Port</b>	Switch port number.
• <b>Mode</b>	Indicates the filtering mode maintained per (VLAN ID, port number, Group Address) basis. It can be either Include or Exclude.
• <b>Source Address</b>	IP Address of the source. Currently, system limits the total number of IP source addresses for filtering to be 128.
• <b>Type</b>	Indicates the Type. It can be either Allow or Deny.
• <b>Hardware Filter/Switch</b>	Indicates whether data plane destined to the specific group address from the source IPv6 address could be handled by chip or not.

## Buttons

Auto-refresh : Automatic refresh occurs every 3 seconds.

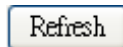
: Refreshes the displayed table starting from the input fields.

: Updates the table starting from the first entry in the MLD SFM Information Table.

: Updates the table, starting with the entry after the last entry currently displayed.

### 4.3.7 MVR (Multicast VLAN Registration)

The MVR feature enables multicast traffic forwarding on the Multicast VLANs.

- In a multicast television application, a PC or a network television or a set-top box can receive the multicast stream.
- Multiple set-top boxes or PCs can be connected to one subscriber port, which is a switch port configured as an MVR receiver port. When a subscriber selects a channel, the set-top box or PC sends an IGMP/MLD report message to Switch A to join the appropriate multicast group address.
- Uplink ports that send and receive multicast data to and from the multicast VLAN are called MVR source ports.

It is allowed to create at maximum 8 MVR VLANs with corresponding channel settings for each Multicast VLAN. There will be totally at maximum 256 group addresses for channel settings.

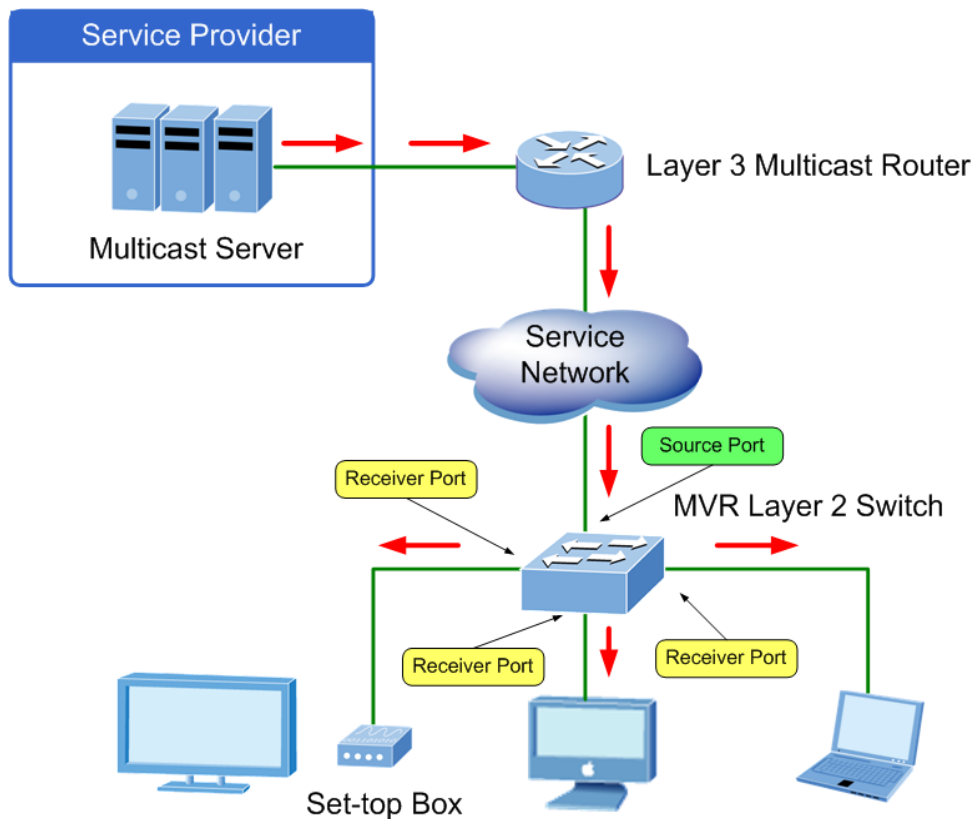

#### 4.3.7.1 MVR Configuration

. This page provides MVR related configuration. The MVR screen in [Figure 4-3-7-1](#) appears

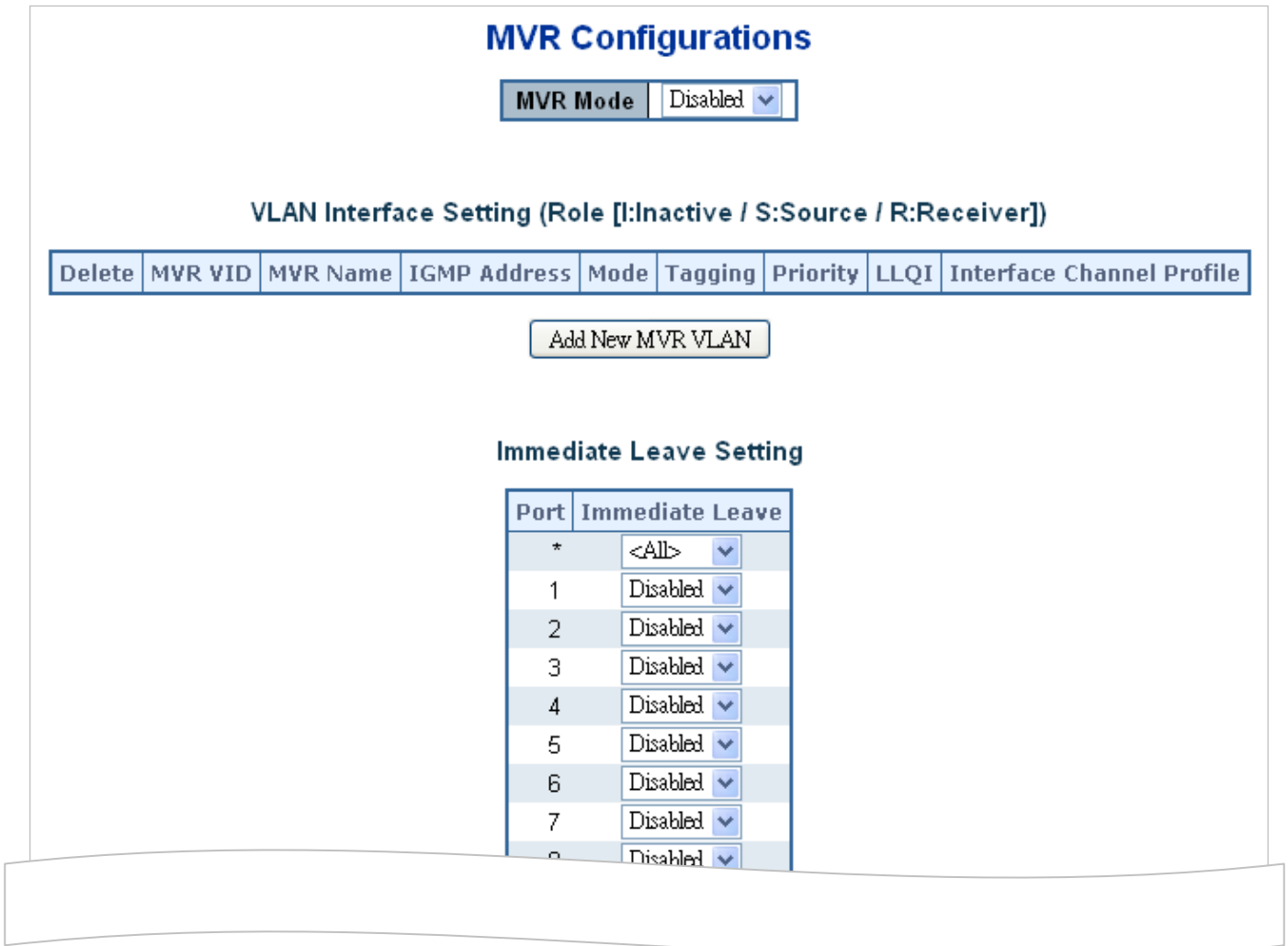

Figure 4-3-7-1: MVR Configuration Page Screenshot

The page includes the following fields:

Object	Description
<ul style="list-style-type: none"> <li><b>MVR Mode</b></li> </ul>	<p>Enable/Disable the Global MVR.</p> <p>The Unregistered Flooding control depends on the current configuration in IGMP/MLD Snooping.</p> <p>It is suggested to enable Unregistered Flooding control when the MVR group table is full.</p>
<ul style="list-style-type: none"> <li><b>Delete</b></li> </ul>	<p>Check to delete the entry. The designated entry will be deleted during the next save.</p>
<ul style="list-style-type: none"> <li><b>MVR VID</b></li> </ul>	<p>Specify the Multicast VLAN ID.</p> <p><b>Be Caution:</b> MVR source ports are not recommended to be overlapped with management VLAN ports.</p>
<ul style="list-style-type: none"> <li><b>MVR Name</b></li> </ul>	<p>MVR Name is an optional attribute to indicate the name of the specific MVR VLAN. Maximum length of the MVR VLAN Name string is 16. MVR VLAN Name can only contain alphabets or numbers. When the optional MVR VLAN name is given, it should contain at least one alphabet. MVR VLAN name can be edited for</p>

	the existing MVR VLAN entries or it can be added to the new entries.
<ul style="list-style-type: none"> <li>• <b>IGMP Address</b></li> </ul>	<p>Define the IPv4 address as source address used in IP header for IGMP control frames. The default IGMP address is not set (0.0.0.0).</p> <p>When the IGMP address is not set, system uses IPv4 management address of the IP interface associated with this VLAN.</p> <p>When the IPv4 management address is not set, system uses the first available IPv4 management address. Otherwise, system uses a pre-defined value. By default, this value will be 192.0.2.1.</p>
<ul style="list-style-type: none"> <li>• <b>Mode</b></li> </ul>	<p>Specify the MVR mode of operation. In Dynamic mode, MVR allows dynamic MVR membership reports on source ports. In Compatible mode, MVR membership reports are forbidden on source ports. The default is Dynamic mode.</p>
<ul style="list-style-type: none"> <li>• <b>Tagging</b></li> </ul>	<p>Specify whether the traversed IGMP/MLD control frames will be sent as Untagged or Tagged with MVR VID. The default is Tagged.</p>
<ul style="list-style-type: none"> <li>• <b>Priority</b></li> </ul>	<p>Specify how the traversed IGMP/MLD control frames will be sent in prioritized manner. The default Priority is 0.</p>
<ul style="list-style-type: none"> <li>• <b>LLQI</b></li> </ul>	<p>Define the maximum time to wait for IGMP/MLD report memberships on a receiver port before removing the port from multicast group membership. The value is in units of tenths of a seconds. The range is from 0 to 31744. The default LLQI is 5 tenths or one-half second.</p>
<ul style="list-style-type: none"> <li>• <b>Interface Channel Setting</b></li> </ul>	<p>When the MVR VLAN is created, select the IPMC Profile as the channel filtering condition for the specific MVR VLAN. Summary about the Interface Channel Profiling (of the MVR VLAN) will be shown by clicking the view button. Profile selected for designated interface channel is not allowed to have overlapped permit group address.</p>
<ul style="list-style-type: none"> <li>• <b>Port</b></li> </ul>	<p>The logical port for the settings.</p>
<ul style="list-style-type: none"> <li>• <b>Port Role</b></li> </ul>	<p>Configure an MVR port of the designated MVR VLAN as one of the following roles.</p> <ul style="list-style-type: none"> <li>■ <b>Inactive:</b> The designated port does not participate MVR operations.</li> <li>■ <b>Source:</b> Configure uplink ports that receive and send multicast data as source ports. Subscribers cannot be directly connected to source ports.</li> <li>■ <b>Receiver:</b> Configure a port as a receiver port if it is a subscriber port and should only receive multicast data. It does not receive data unless it becomes a member of the multicast group by issuing IGMP/MLD messages.</li> </ul> <p><b>Be Caution:</b> MVR source ports are not recommended to be overlapped with management VLAN ports.</p> <p>Select the port role by clicking the Role symbol to switch the setting.</p> <p>I indicates Inactive; S indicates Source; R indicates Receiver</p> <p>The default Role is Inactive.</p>

<ul style="list-style-type: none"> <li>• <b>Immediate Leave</b></li> </ul>	Enable the fast leave on the port.
--	------------------------------------

**Buttons**

- Add New MVR VLAN**: Click to add new MVR VLAN. Specify the VID and configure the new entry. Click "Save"
- Apply**: Click to apply changes
- Reset**: Click to undo any changes made locally and revert to previously saved values.

**4.3.7.2 MVR Status**

This page provides MVR status. The MVR Status screen in [Figure 4-3-7-2](#) appears.

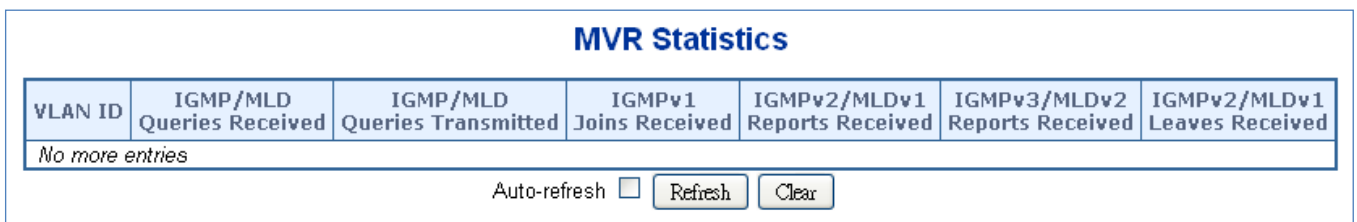

**Figure 4-3-7-2: MVR Status Page Screenshot**

The page includes the following fields:

Object	Description
• <b>VLAN ID</b>	The Multicast VLAN ID.
• <b>IGMP/MLD Queries Received</b>	The number of Received Queries for IGMP and MLD, respectively.
• <b>IGMP/MLD Queries Transmitted</b>	The number of Transmitted Queries for IGMP and MLD, respectively.
• <b>IGMPv1 Joins Received</b>	The number of Received IGMPv1 Joins.
• <b>IGMPv2/MLDv1 Reports Received</b>	The number of Received IGMPv2 Joins and MLDv1 Reports, respectively.
• <b>IGMPv3/MLDv2 Reports Received</b>	The number of Received IGMPv1 Joins and MLDv2 Reports, respectively.
• <b>IGMPv2/MLDv1 Leaves Received</b>	The number of Received IGMPv2 Leaves and MLDv1 Dones, respectively.

**Buttons**

- Refresh**: Click to refresh the page immediately.
- Clear**: Clears all Statistics counters.

Auto-refresh : Automatic refresh occurs every 3 seconds.



### 4.3.7.3 MVR Groups Information

Entries in the MVR Group Table are shown on this page. The MVR Group Table is sorted first by VLAN ID, and then by group. Each page shows up to 99 entries from the MVR Group table, default being 20, selected through the "entries per page" input field. When first visited, the web page will show the first 20 entries from the beginning of the MVR Group Table.

The "Start from VLAN", and "group" input fields allow the user to select the starting point in the MVR Group Table. The MVR Groups Information screen in [Figure 4-3-7-3](#) appears.

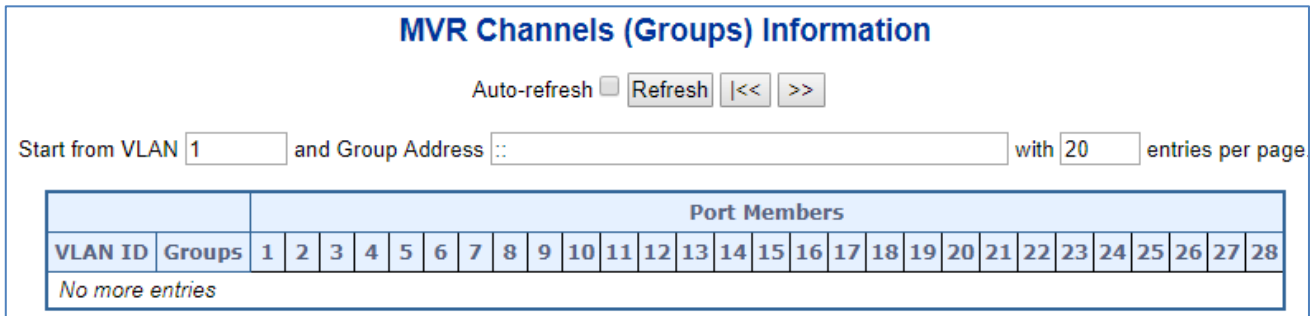

Figure 4-3-7-3: MVR Groups Information Page Screenshot

The page includes the following fields:

Object	Description
• VLAN	VLAN ID of the group.
• Groups	Group ID of the group displayed.
• Port Members	Ports under this group.

#### Buttons

Auto-refresh : Automatic refresh occurs every 3 seconds.

: Refreshes the displayed table starting from the input fields.

: Updates the table starting from the first entry in the MVR Channels (Groups) Information Table.

: Updates the table, starting with the entry after the last entry currently displayed.

### 4.3.7.4 MVR SFM Information

Entries in the MVR SFM Information Table are shown on this page. The MVR **SFM (Source-Filtered Multicast)** Information Table also contains the SSM (Source-Specific Multicast) information. This table is sorted first by VLAN ID, then by group, and then by Port. Different source addresses belong to the same group are treated as single entry.

Each page shows up to 99 entries from the MVR SFM Information Table, default being 20, selected through the "entries per page" input field. When first visited, the web page will show the first 20 entries from the beginning of the MVR SFM Information Table.

The "Start from VLAN", and "Group Address" input fields allow the user to select the starting point in the MVR SFM Information Table. The MVR SFM Information screen in [Figure 4-3-7-4](#) appears.



Figure 4-3-7-4: MVR SFM Information Page Screenshot

The page includes the following fields:

Object	Description
• <b>VLAN ID</b>	VLAN ID of the group.
• <b>Group</b>	Group address of the group displayed.
• <b>Port</b>	Switch port number.
• <b>Mode</b>	Indicates the filtering mode maintained per (VLAN ID, port number, Group Address) basis. It can be either Include or Exclude.
• <b>Source Address</b>	IP Address of the source. Currently, system limits the total number of IP source addresses for filtering to be 128. When there is no any source filtering address, the text "None" is shown in the Source Address field.
• <b>Type</b>	Indicates the Type. It can be either Allow or Deny.
• <b>Hardware Filter / Switch</b>	Indicates whether data plane destined to the specific group address from the source IPv4/IPv6 address could be handled by chip or not.

**Buttons**

Auto-refresh : Automatic refresh occurs every 3 seconds.

: Refreshes the displayed table starting from the input fields.

: Updates the table starting from the first entry in the MVR SFM Information Table.

### 4.3.8 LLDP

#### 4.3.8.1 Link Layer Discovery Protocol

**Link Layer Discovery Protocol (LLDP)** is used to discover basic information about neighboring devices on the local broadcast domain. LLDP is a Layer 2 protocol that uses periodic broadcasts to advertise information about the sending device. Advertised information is represented in **Type Length Value (TLV)** format according to the IEEE 802.1ab standard, and can include details such as device identification, capabilities and configuration settings. LLDP also defines how to store and maintain information gathered about the neighboring network nodes it discovers.

**Link Layer Discovery Protocol - Media Endpoint Discovery (LLDP-MED)** is an extension of LLDP intended for managing endpoint devices such as Voice over IP phones and network switches. The LLDP-MED TLVs advertise information such as network policy, power, inventory, and device location details. LLDP and LLDP-MED information can be used by SNMP applications to simplify troubleshooting, enhance network management, and maintain an accurate network topology.

#### 4.3.8.2 LLDP Configuration

This page allows the user to inspect and configure the current LLDP port settings. The LLDP Configuration screen in [Figure 4-3-8-1](#) appears.

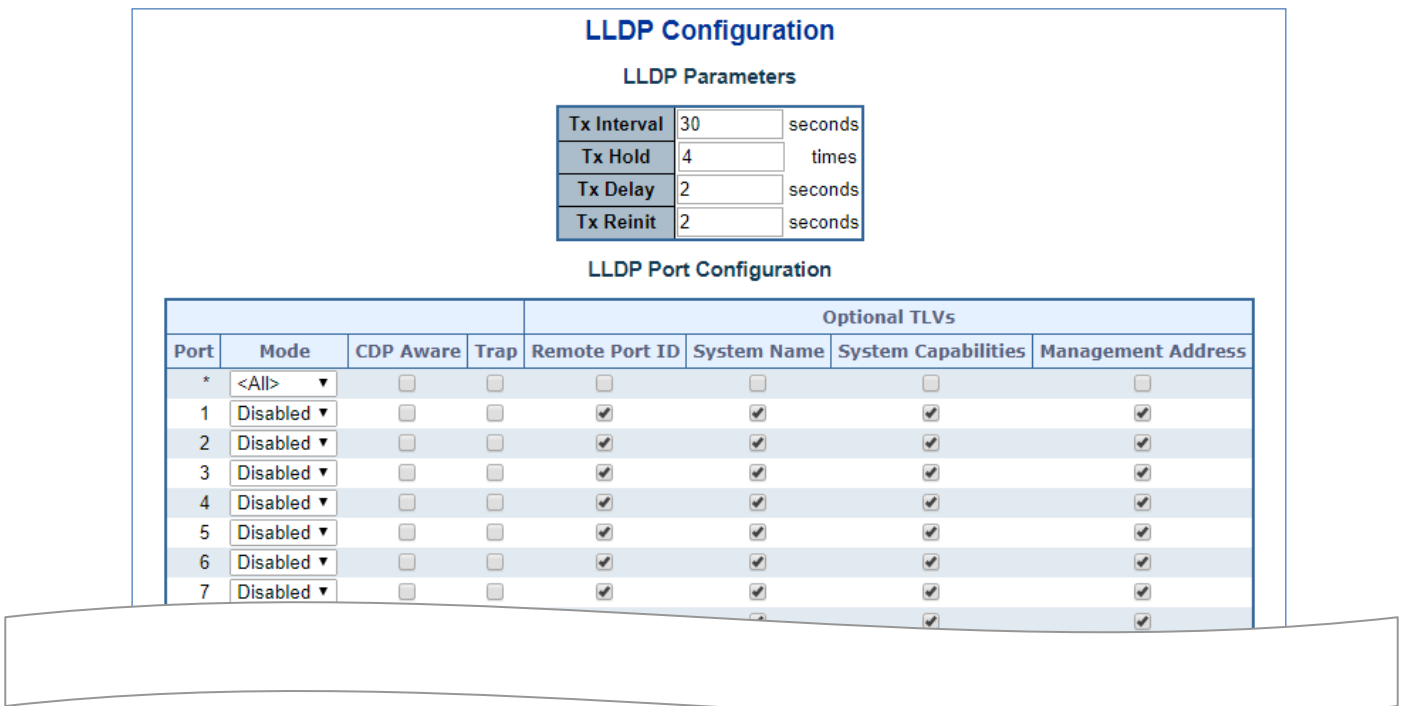

Figure 4-3-8-1: LLDP Configuration Page Screenshot

The page includes the following fields:

#### LLDP Parameters

Object	Description
• Tx Interval	The switch is periodically transmitting LLDP frames to its neighbors for having

	<p>the network discovery information up-to-date. The interval between each LLDP frame is determined by the <b>Tx Interval</b> value. Valid values are restricted to 5 - 32768 seconds.</p> <p>Default: <b>30</b> seconds</p> <p>This attribute must comply with the following rule:  <a href="#">(Transmission Interval * Hold Time Multiplier) ≤ 65536, and Transmission Interval ≥ (4 * Delay Interval)</a></p>
<ul style="list-style-type: none"> <li>• <b>Tx Hold</b></li> </ul>	<p>Each LLDP frame contains information about how long the information in the LLDP frame shall be considered valid. The LLDP information valid period is set to <b>Tx Hold</b> multiplied by <b>Tx Interval</b> seconds. Valid values are restricted to 2 - 10 times.</p> <p>TTL in seconds is based on the following rule:  <a href="#">(Transmission Interval * Holdtime Multiplier) ≤ 65536.</a>            Therefore, the default TTL is 4*30 = 120 seconds.</p>
<ul style="list-style-type: none"> <li>• <b>Tx Delay</b></li> </ul>	<p>If some configuration is changed (e.g. the IP address) a new LLDP frame is transmitted, but the time between the LLDP frames will always be at least the value of <b>Tx Delay</b> seconds. <b>Tx Delay</b> cannot be larger than 1/4 of the <b>Tx Interval</b> value. Valid values are restricted to 1 - 8192 seconds.</p> <p>This attribute must comply with the rule:  <a href="#">(4 * Delay Interval) ≤ Transmission Interval</a></p>
<ul style="list-style-type: none"> <li>• <b>Tx Reinit</b></li> </ul>	<p>When a port is disabled, LLDP is disabled or the switch is rebooted a LLDP shutdown frame is transmitted to the neighboring units, signaling that the LLDP information isn't valid anymore. <b>Tx Reinit</b> controls the amount of seconds between the shutdown frame and a new LLDP initialization. Valid values are restricted to 1 - 10 seconds.</p>

### LLDP Port Configuration

The LLDP port settings relate to the switch, as reflected by the page header.

Object	Description
<ul style="list-style-type: none"> <li>• <b>Port</b></li> </ul>	The switch port number of the logical LLDP port.
<ul style="list-style-type: none"> <li>• <b>Mode</b></li> </ul>	<p>Select LLDP mode.</p> <ul style="list-style-type: none"> <li>■ <b>Rx only</b> The switch will not send out LLDP information, but LLDP information from neighbor units is analyzed.</li> <li>■ <b>Tx only</b> The switch will drop LLDP information received from neighbors, but will send out LLDP information.</li> <li>■ <b>Disabled</b> The switch will not send out LLDP information, and will drop LLDP information received from neighbors.</li> <li>■ <b>Enabled</b> The switch will send out LLDP information, and will analyze LLDP</li> </ul>

	information received from neighbors.
<ul style="list-style-type: none"> <li>• <b>CDP Aware</b></li> </ul>	<p>Select CDP awareness.</p> <p>The CDP operation is restricted to decoding incoming CDP frames (<b>The switch doesn't transmit CDP frames</b>). CDP frames are only decoded if LLDP on the port is enabled.</p> <p>Only CDP TLVs that can be mapped to a corresponding field in the LLDP neighbours' table are decoded. All other TLVs are discarded (Unrecognized CDP TLVs and discarded CDP frames are not shown in the LLDP statistics.). CDP TLVs are mapped onto LLDP neighbours' table as shown below.</p> <p>CDP TLV "Device ID" is mapped to the LLDP "Chassis ID" field.</p> <p>CDP TLV "Address" is mapped to the LLDP "Management Address" field. The CDP address TLV can contain multiple addresses, but only the first address is shown in the LLDP neighbours table.</p> <p>CDP TLV "Port ID" is mapped to the LLDP "Port ID" field.</p> <p>CDP TLV "Version and Platform" is mapped to the LLDP "System Description" field.</p> <p>Both the CDP and LLDP support "system capabilities", but the CDP capabilities cover capabilities that are not part of the LLDP. These capabilities are shown as "others" in the LLDP neighbours' table.</p> <p>If all ports have CDP awareness disabled the switch forwards CDP frames received from neighbour devices. If at least one port has CDP awareness enabled all CDP frames are terminated by the switch.</p> <p>Note: When CDP awareness on a port is disabled the CDP information isn't removed immediately, but gets removed when the hold time is exceeded.</p>
<ul style="list-style-type: none"> <li>• <b>Port Description</b></li> </ul>	Optional TLV: When checked the "port description" is included in LLDP information transmitted.
<ul style="list-style-type: none"> <li>• <b>System Name</b></li> </ul>	Optional TLV: When checked the "system name" is included in LLDP information transmitted.
<ul style="list-style-type: none"> <li>• <b>System Description</b></li> </ul>	Optional TLV: When checked the "system description" is included in LLDP information transmitted.
<ul style="list-style-type: none"> <li>• <b>System Capabilities</b></li> </ul>	Optional TLV: When checked the "system capability" is included in LLDP information transmitted.
<ul style="list-style-type: none"> <li>• <b>Management Address</b></li> </ul>	Optional TLV: When checked the "management address" is included in LLDP information transmitted.

**Buttons**

 : Click to apply changes

 : Click to undo any changes made locally and revert to previously saved values.

**4.3.8.3 LLDP Neighbor**

This page provides a status overview for all LLDP neighbors. The displayed table contains a row for each port on which an LLDP neighbor is detected. The LLDP Neighbor Information screen in [Figure 4-3-8-2](#) appears.

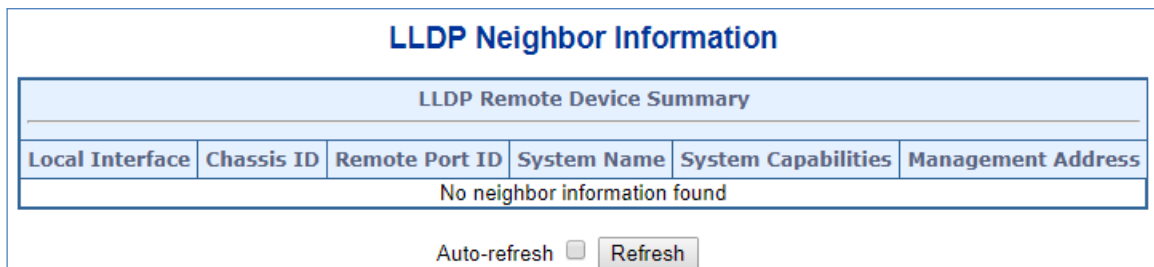

**Figure 4-3-8-2:** LLDP Neighbor Information Page Screenshot

The page includes the following fields:

Object	Description
• <b>Local Port</b>	The port on which the LLDP frame was received.
• <b>Chassis ID</b>	The Chassis ID is the identification of the neighbor's LLDP frames.
• <b>Remote Port ID</b>	The Remote Port ID is the identification of the neighbor port.
• <b>Port Description</b>	Port Description is the port description advertised by the neighbor unit.
• <b>System Name</b>	System Name is the name advertised by the neighbor unit.
• <b>System Capabilities</b>	<p>System Capabilities describes the neighbor unit's capabilities. The possible capabilities are:</p> <ol style="list-style-type: none"> <li>1. Other</li> <li>2. Repeater</li> <li>3. Bridge</li> <li>4. WLAN Access Point</li> <li>5. Router</li> <li>6. Telephone</li> <li>7. DOCSIS cable device</li> <li>8. Station only</li> <li>9. Reserved</li> </ol> <p>When a capability is enabled, the capability is followed by (+). If the capability is disabled, the capability is followed by (-).</p>

---

<ul style="list-style-type: none"><li>• <b>Management Address</b></li></ul>	Management Address is the neighbor unit's address that is used for higher layer entities to assist the discovery by the network management. This could for instance hold the neighbor's IP address.
---	---

---

: Click to refresh the page immediately.

Auto-refresh  Check this box to refresh the page automatically. Automatic refresh occurs every 3 seconds.

### 4.3.8.4 LLDP MED Configuration

This page allows you to configure the LLDP-MED. The LLDPMED Configuration screen in [Figure 4-3-8-3](#) appears.

**LLDP-MED Configuration**

Fast Start Repeat Count

Fast start repeat count

LLDP-MED Interface Configuration

Transmit TLVs				
Port	Capabilities	Policies	Location	Device Type
*	-	-	-	<All> ▼
1	-	-	-	Connectivity ▼
2	-	-	-	Connectivity ▼
3	-	-	-	Connectivity ▼
4	-	-	-	Connectivity ▼
5	-	-	-	Connectivity ▼
6	-	-	-	Connectivity ▼
7	-	-	-	Connectivity ▼
8	-	-	-	Connectivity ▼
9	-	-	-	Connectivity ▼
10	-	-	-	Connectivity ▼
11	-	-	-	Connectivity ▼
12	-	-	-	Connectivity ▼
13	-	-	-	Connectivity ▼
14	-	-	-	Connectivity ▼
15	-	-	-	Connectivity ▼
16	-	-	-	Connectivity ▼
17	-	-	-	Connectivity ▼
18	-	-	-	Connectivity ▼
19	-	-	-	Connectivity ▼
20	-	-	-	Connectivity ▼
21	-	-	-	Connectivity ▼
22	-	-	-	Connectivity ▼
23	-	-	-	Connectivity ▼
24	-	-	-	Connectivity ▼
25	-	-	-	Connectivity ▼
26	-	-	-	Connectivity ▼
27	-	-	-	Connectivity ▼
28	-	-	-	Connectivity ▼

Coordinates Location

Latitude  ° North ▼ Longitude  ° East ▼ Altitude  Meters ▼ Map Datum WGS84 ▼

Civic Address Location

Country code	<input type="text"/>	State	<input type="text"/>	County	<input type="text"/>
City	<input type="text"/>	City district	<input type="text"/>	Block (Neighborhood)	<input type="text"/>
Street	<input type="text"/>	Leading street direction	<input type="text"/>	Trailing street suffix	<input type="text"/>
Street suffix	<input type="text"/>	House no.	<input type="text"/>	House no. suffix	<input type="text"/>
Landmark	<input type="text"/>	Additional location info	<input type="text"/>	Name	<input type="text"/>
Zip code	<input type="text"/>	Building	<input type="text"/>	Apartment	<input type="text"/>
Floor	<input type="text"/>	Room no.	<input type="text"/>	Place type	<input type="text"/>
Postal community name	<input type="text"/>	P.O. Box	<input type="text"/>	Additional code	<input type="text"/>

Emergency Call Service

Emergency Call Service

Policies

Delete	Policy ID	Application Type	Tag	VLAN ID	L2 Priority	DSCP
No entries present						

Figure 4-3-8-3: LLDPMED Configuration Page Screenshot

The page includes the following fields:

#### Fast start repeat count

Object	Description
<ul style="list-style-type: none"> <li>Fast start repeat count</li> </ul>	Rapid startup and Emergency Call Service Location Identification Discovery of



endpoints is a critically important aspect of VoIP systems in general. In addition, it is best to advertise only those pieces of information which are specifically relevant to particular endpoint types (for example only advertise the voice network policy to permitted voice-capable devices), both in order to conserve the limited LLDPDU space and to reduce security and system integrity issues that can come with inappropriate knowledge of the network policy.

With this in mind LLDP-MED defines an LLDP-MED Fast Start interaction between the protocol and the application layers on top of the protocol, in order to achieve these related properties. Initially, a Network Connectivity Device will only transmit LLDP TLVs in an LLDPDU. Only after an LLDP-MED Endpoint Device is detected, will an LLDP-MED capable Network Connectivity Device start to advertise LLDP-MED TLVs in outgoing LLDPDUs on the associated port. The LLDP-MED application will temporarily speed up the transmission of the LLDPDU to start within a second, when a new LLDP-MED neighbour has been detected in order share LLDP-MED information as fast as possible to new neighbours.

Because there is a risk of an LLDP frame being lost during transmission between neighbours, it is recommended to repeat the fast start transmission multiple times to increase the possibility of the neighbours receiving the LLDP frame. With **Fast start repeat count** it is possible to specify the number of times the fast start transmission would be repeated. The recommended value is 4 times, given that 4 LLDP frames with a 1 second interval will be transmitted, when an LLDP frame with new information is received.

It should be noted that LLDP-MED and the LLDP-MED Fast Start mechanism is only intended to run on links between LLDP-MED Network Connectivity Devices and Endpoint Devices, and as such does not apply to links between LAN infrastructure elements, including Network Connectivity Devices, or other types of links.

### LLDP-MED Interface Configuration

Object	Description
• <b>Interface</b>	The interface name to which the configuration applies.
• <b>Transmit TLVs - Capabilities</b>	When checked the switch's capabilities is included in <a href="#">LLDP-MED</a> information transmitted
• <b>Transmit TLVs - Policies</b>	When checked the configured policies for the interface is included in <a href="#">LLDP-MED</a> information transmitted.
• <b>Transmit TLVs - Location</b>	When checked the configured location information for the switch is included in <a href="#">LLDP-MED</a> information transmitted.
• <b>Transmit TLVs - PoE</b>	When checked the configured PoE (Power Over Ethernet) information for the

	interface is included in <a href="#">LLDP-MED</a> information transmitted
<ul style="list-style-type: none"> <li>• <b>Device Type</b></li> </ul>	<p>Any LLDP-MED Device is operating as a specific type of LLDP-MED Device, which may be either a Network Connectivity Device or a specific Class of Endpoint Device, as defined below.</p> <p>A Network Connectivity Device is a LLDP-MED Device that provides access to the IEEE 802 based LAN infrastructure for LLDP-MED Endpoint Devices</p> <p>An LLDP-MED Network Connectivity Device is a LAN access device based on any of the following technologies :</p> <ol style="list-style-type: none"> <li>1. LAN Switch/Router</li> <li>2. IEEE 802.1 Bridge</li> <li>3. IEEE 802.3 Repeater (included for historical reasons)</li> <li>4. IEEE 802.11 Wireless Access Point</li> <li>5. Any device that supports the IEEE 802.1AB and MED extensions that can relay IEEE 802 frames via any method.</li> </ol> <p>An Endpoint Device a LLDP-MED Device that sits at the network edge and provides some aspect of IP communications service, based on IEEE 802 LAN technology.</p> <p>The main difference between a Network Connectivity Device and an Endpoint Device is that only an Endpoint Device can start the LLDP-MED information exchange.</p> <p>Even though a switch always should be a Network Connectivity Device, it is possible to configure it to act as an Endpoint Device, and thereby start the LLDP-MED information exchange (In the case where two Network Connectivity Devices are connected together)</p>

**Coordinates Location**

Object	Description
<ul style="list-style-type: none"> <li>• <b>Latitude</b></li> </ul>	<p><b>Latitude</b> SHOULD be normalized to within 0-90 degrees with a maximum of 4 digits.</p> <p>It is possible to specify the direction to either <b>North</b> of the equator or <b>South</b> of the equator.</p>
<ul style="list-style-type: none"> <li>• <b>Longitude</b></li> </ul>	<p><b>Longitude</b> SHOULD be normalized to within 0-180 degrees with a maximum of 4 digits.</p> <p>It is possible to specify the direction to either <b>East</b> of the prime meridian or <b>West</b> of the prime meridian.</p>
<ul style="list-style-type: none"> <li>• <b>Altitude</b></li> </ul>	<p><b>Altitude</b> SHOULD be normalized to within -32767 to 32767 with a maximum of 4 digits.</p>

	<p>It is possible to select between two altitude types (floors or meters).</p> <p><b>Meters:</b> Representing meters of Altitude defined by the vertical datum specified.</p> <p><b>Floors:</b> Representing altitude in a form more relevant in buildings which have different floor-to-floor dimensions. An altitude = 0.0 is meaningful even outside a building, and represents ground level at the given latitude and longitude. Inside a building, 0.0 represents the floor level associated with ground level at the main entrance.</p>
<ul style="list-style-type: none"> <li>• <b>Map Datum</b></li> </ul>	<p>The <b>Map Datum</b> used for the coordinates given in this Option</p> <ul style="list-style-type: none"> <li>■ <b>WGS84:</b> (Geographical 3D) - World Geodesic System 1984, CRS Code 4327, Prime Meridian Name: Greenwich.</li> <li>■ <b>NAD83/NAVD88:</b> North American Datum 1983, CRS Code 4269, Prime Meridian Name: Greenwich; The associated vertical datum is the North American Vertical Datum of 1988 (NAVD88). This datum pair is to be used when referencing locations on land, not near tidal water (which would use Datum = NAD83/MLLW).</li> <li>■ <b>NAD83/MLLW:</b> North American Datum 1983, CRS Code 4269, Prime Meridian Name: Greenwich; The associated vertical datum is Mean Lower Low Water (MLLW). This datum pair is to be used when referencing locations on water/sea/ocean.</li> </ul>

**Civic Address Location**

IETF Geopriv Civic Address based Location Configuration Information (Civic Address LCI).

Object	Description
<ul style="list-style-type: none"> <li>• <b>Country code</b></li> </ul>	The two-letter ISO 3166 country code in capital ASCII letters - Example: DK, DE or US.
<ul style="list-style-type: none"> <li>• <b>State</b></li> </ul>	National subdivisions (state, canton, region, province, prefecture).
<ul style="list-style-type: none"> <li>• <b>County</b></li> </ul>	County, parish, gun (Japan), district.
<ul style="list-style-type: none"> <li>• <b>City</b></li> </ul>	City, township, shi (Japan) - Example: Copenhagen
<ul style="list-style-type: none"> <li>• <b>City district</b></li> </ul>	City division, borough, city district, ward, chou (Japan)
<ul style="list-style-type: none"> <li>• <b>Block (Neighborhood)</b></li> </ul>	Neighborhood, block
<ul style="list-style-type: none"> <li>• <b>Street</b></li> </ul>	Street - Example: Poppelvej
<ul style="list-style-type: none"> <li>• <b>Leading street direction</b></li> </ul>	Leading street direction - Example: N
<ul style="list-style-type: none"> <li>• <b>Trailing street suffix</b></li> </ul>	Trailing street suffix - Example: SW
<ul style="list-style-type: none"> <li>• <b>Street suffix</b></li> </ul>	Street suffix - Example: Ave, Platz
<ul style="list-style-type: none"> <li>• <b>House no.</b></li> </ul>	House number - Example: 21
<ul style="list-style-type: none"> <li>• <b>House no. suffix</b></li> </ul>	House number suffix - Example: A, 1/2
<ul style="list-style-type: none"> <li>• <b>Landmark</b></li> </ul>	Landmark or vanity address - Example: Columbia University
<ul style="list-style-type: none"> <li>• <b>Additional location</b></li> </ul>	Additional location info - Example: South Wing

<b>info</b>	
• <b>Name</b>	Name (residence and office occupant) - Example: Flemming Jahn
• <b>Zip code</b>	Postal/zip code - Example: 2791
• <b>Building</b>	Building (structure) - Example: Low Library
• <b>Apartment</b>	Unit (Apartment, suite) - Example: Apt 42
• <b>Floor</b>	Floor - Example: 4
• <b>Room no.</b>	Room number - Example: 450F
• <b>Place type</b>	Place type - Example: Office
• <b>Postal community name</b>	Postal community name - Example: Leonia
• <b>P.O. Box</b>	Post office box (P.O. BOX) - Example: 12345
• <b>Additional code</b>	Additional code - Example: 1320300003

### Emergency Call Service

Emergency Call Service (e.g. E911 and others), such as defined by TIA or NENA.

Object	Description
• <b>Emergency Call Service</b>	<b>Emergency Call Service</b> ELIN identifier data format is defined to carry the ELIN identifier as used during emergency call setup to a traditional CAMA or ISDN trunk-based PSAP. This format consists of a numerical digit string, corresponding to the ELIN to be used for emergency calling.

### Policies

Network Policy Discovery enables the efficient discovery and diagnosis of mismatch issues with the VLAN configuration, along with the associated Layer 2 and Layer 3 attributes, which apply for a set of specific protocol applications on that port. Improper network policy configurations are a very significant issue in VoIP environments that frequently result in voice quality degradation or loss of service.

Policies are only intended for use with applications that have specific 'real-time' network policy requirements, such as interactive voice and/or video services.

The network policy attributes advertised are:

1. Layer 2 VLAN ID (IEEE 802.1Q-2003)
2. Layer 2 priority value (IEEE 802.1D-2004)
3. Layer 3 Diffserv code point (DSCP) value (IETF RFC 2474)

This network policy is potentially advertised and associated with multiple sets of application types supported on a given port.

The application types specifically addressed are:

1. Voice

2. Guest Voice
3. Softphone Voice
4. Video Conferencing
5. Streaming Video
6. Control / Signaling (conditionally support a separate network policy for the media types above)

A large network may support multiple VoIP policies across the entire organization, and different policies per application type. LLDP-MED allows multiple policies to be advertised per port, each corresponding to a different application type. Different ports on the same Network Connectivity Device may advertise different sets of policies, based on the authenticated user identity or port configuration.

It should be noted that LLDP-MED is not intended to run on links other than between Network Connectivity Devices and Endpoints, and therefore does not need to advertise the multitude of network policies that frequently run on an aggregated link interior to the LAN.

Object	Description
<ul style="list-style-type: none"> <li>• <b>Delete</b></li> </ul>	Check to delete the policy. It will be deleted during the next save.
<ul style="list-style-type: none"> <li>• <b>Policy ID</b></li> </ul>	ID for the policy. This is auto generated and shall be used when selecting the polices that shall be mapped to the specific ports.
<ul style="list-style-type: none"> <li>• <b>Application Type</b></li> </ul>	Intended use of the application types: <ul style="list-style-type: none"> <li>■ <b>Voice</b> - for use by dedicated IP Telephony handsets and other similar appliances supporting interactive voice services. These devices are typically deployed on a separate VLAN for ease of deployment and enhanced security by isolation from data applications.</li> <li>■ <b>Voice Signaling (conditional)</b> - for use in network topologies that require a different policy for the voice signaling than for the voice media. This application type should not be advertised if all the same network policies apply as those advertised in the Voice application policy.</li> <li>■ <b>Guest Voice</b> - support a separate 'limited feature-set' voice service for guest users and visitors with their own IP Telephony handsets and other similar appliances supporting interactive voice services.</li> <li>■ <b>Guest Voice Signaling (conditional)</b> - for use in network topologies that require a different policy for the guest voice signaling than for the guest voice media. This application type should not be advertised if all the same network policies apply as those advertised in the Guest Voice application policy.</li> <li>■ <b>Softphone Voice</b> - for use by softphone applications on typical data centric devices, such as PCs or laptops. This class of endpoints frequently does not support multiple VLANs, if at all, and are typically configured to use an 'untagged' VLAN or a single 'tagged' data specific</li> </ul>

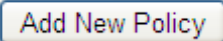
	<p>VLAN. When a network policy is defined for use with an 'untagged' VLAN (see Tagged flag below), then the L2 priority field is ignored and only the DSCP value has relevance.</p> <ul style="list-style-type: none"> <li>■ <b>Video Conferencing</b> - for use by dedicated Video Conferencing equipment and other similar appliances supporting real-time interactive video/audio services.</li> <li>■ <b>Streaming Video</b> - for use by broadcast or multicast based video content distribution and other similar applications supporting streaming video services that require specific network policy treatment. Video applications relying on TCP with buffering would not be an intended use of this application type.</li> <li>■ <b>Video Signaling (conditional)</b> - for use in network topologies that require a separate policy for the video signaling than for the video media. This application type should not be advertised if all the same network policies apply as those advertised in the Video Conferencing application policy.</li> </ul>
<ul style="list-style-type: none"> <li>• <b>Tag</b></li> </ul>	<p><b>Tag</b> indicating whether the specified application type is using a 'tagged' or an 'untagged' VLAN.</p> <ul style="list-style-type: none"> <li>■ <b>Untagged</b> indicates that the device is using an untagged frame format and as such does not include a tag header as defined by IEEE 802.1Q-2003. In this case, both the VLAN ID and the Layer 2 priority fields are ignored and only the DSCP value has relevance.</li> <li>■ <b>Tagged</b> indicates that the device is using the IEEE 802.1Q tagged frame format, and that both the VLAN ID and the Layer 2 priority values are being used, as well as the DSCP value. The tagged format includes an additional field, known as the tag header. The tagged frame format also includes priority tagged frames as defined by IEEE 802.1Q-2003.</li> </ul>
<ul style="list-style-type: none"> <li>• <b>VLAN ID</b></li> </ul>	<p>VLAN identifier (VID) for the port as defined in IEEE 802.1Q-2003</p>
<ul style="list-style-type: none"> <li>• <b>L2 Priority</b></li> </ul>	<p>L2 Priority is the Layer 2 priority to be used for the specified application type. L2 Priority may specify one of eight priority levels (0 through 7), as defined by IEEE 802.1D-2004. A value of 0 represents use of the default priority as defined in IEEE 802.1D-2004.</p>
<ul style="list-style-type: none"> <li>• <b>DSCP</b></li> </ul>	<p>DSCP value to be used to provide Diffserv node behavior for the specified application type as defined in IETF RFC 2474. DSCP may contain one of 64 code point values (0 through 63). A value of 0 represents use of the default DSCP value as defined in RFC 2475.</p>
<ul style="list-style-type: none"> <li>• <b>Adding a new policy</b></li> </ul>	<p>Click  to add a new policy. Specify the <b>Application type</b>, <b>Tag</b>, <b>VLAN ID</b>, <b>L2 Priority</b> and <b>DSCP</b> for the new policy. Click "Save". The number of policies supported is 32</p>



### Port Policies Configuration

Every port may advertise a unique set of network policies or different attributes for the same network policies, based on the authenticated user identity or port configuration.

Object	Description
<ul style="list-style-type: none"> <li>Port</li> </ul>	The port number for which the configuration applies.
<ul style="list-style-type: none"> <li>Policy ID</li> </ul>	The set of policies that shall apply for a given port. The set of policies is selected by checkmarking the checkboxes that corresponds to the policies

#### Buttons

**Apply** : Click to apply changes

**Reset** : Click to undo any changes made locally and revert to previously saved values.

#### 4.3.8.5 LLDP-MED Neighbor

This page provides a status overview for all LLDP-MED neighbors. The displayed table contains a row for each port on which an LLDP neighbor is detected. The LLDP-MED Neighbor Information screen in [Figure 4-3-8-4](#) appears. The columns hold the following information:

LLDP-MED Neighbour Information					
Port 1					
Device Type	Capabilities				
Endpoint Class III	LLDP-MED Capabilities, Network Policy, Extended Power via MDI - PD, Inventory				
Application Type	Policy	Tag	VLAN ID	Priority	DSCP
Voice	Defined	Untagged	-	-	46
Voice Signaling	Defined	Untagged	-	-	32
Auto-negotiation	Auto-negotiation status	Auto-negotiation Capabilities		MAU Type	
Supported	Enabled	1000BASE-T half duplex mode, 1000BASE-X, -LX, -SX, -CX full duplex mode, Asymmetric and Symmetric PAUSE for full-duplex links, Symmetric PAUSE for full-duplex links		100BaseTXFD - 2 pair category 5 UTP, full duplex mode	

Figure 4-3-8-3: LLDP-MED Neighbor Information Page Screenshot



The page includes the following fields:

**Fast start repeat count**

Object	Description
<ul style="list-style-type: none"> <li>• Port</li> </ul>	<p>The port on which the LLDP frame was received.</p>
<ul style="list-style-type: none"> <li>• Device Type</li> </ul>	<p>LLDP-MED Devices are comprised of two primary Device Types: Network Connectivity Devices and Endpoint Devices.</p> <p><b>LLDP-MED Network Connectivity Device Definition</b></p> <p>LLDP-MED Network Connectivity Devices, as defined in TIA-1057, provide access to the IEEE 802 based LAN infrastructure for LLDP-MED Endpoint Devices. An LLDP-MED Network Connectivity Device is a LAN access device based on any of the following technologies:</p> <ol style="list-style-type: none"> <li>1. LAN Switch/Router</li> <li>2. IEEE 802.1 Bridge</li> <li>3. IEEE 802.3 Repeater (included for historical reasons)</li> <li>4. IEEE 802.11 Wireless Access Point</li> <li>5. Any device that supports the IEEE 802.1AB and MED extensions defined by TIA-1057 and can relay IEEE 802 frames via any method.</li> </ol> <p><b>LLDP-MED Endpoint Device Definition</b></p> <p>Within the LLDP-MED Endpoint Device category, the LLDP-MED scheme is broken into further Endpoint Device Classes, as defined in the following. Each LLDP-MED Endpoint Device Class is defined to build upon the capabilities defined for the previous Endpoint Device Class. Fore-example will any LLDP-MED Endpoint Device claiming compliance as a Media Endpoint (Class II) also support all aspects of TIA-1057 applicable to Generic Endpoints (Class I), and any LLDP-MED Endpoint Device claiming compliance as a Communication Device (Class III) will also support all aspects of TIA-1057 applicable to both Media Endpoints (Class II) and Generic Endpoints (Class I).</p> <p><b>LLDP-MED Generic Endpoint (Class I)</b></p> <p>The LLDP-MED Generic Endpoint (Class I) definition is applicable to all endpoint products that require the base LLDP discovery services defined in TIA-1057, however do not support IP media or act as an end-user communication appliance. Such devices may include (but are not limited to) IP Communication Controllers, other communication related servers, or any device requiring basic services as defined in TIA-1057.</p> <p>Discovery services defined in this class include LAN configuration, device location, network policy, power management, and inventory management.</p> <p><b>LLDP-MED Media Endpoint (Class II)</b></p> <p>The LLDP-MED Media Endpoint (Class II) definition is applicable to all endpoint products that have IP media capabilities however may or may not be associated with a particular end user. Capabilities include all of the capabilities defined for</p>

	<p>the previous Generic Endpoint Class (Class I), and are extended to include aspects related to media streaming. Example product categories expected to adhere to this class include (but are not limited to) Voice / Media Gateways, Conference Bridges, Media Servers, and similar.</p> <p>Discovery services defined in this class include media-type-specific network layer policy discovery.</p> <p><b>LLDP-MED Communication Endpoint (Class III)</b></p> <p>The LLDP-MED Communication Endpoint (Class III) definition is applicable to all endpoint products that act as end user communication appliances supporting IP media. Capabilities include all of the capabilities defined for the previous Generic Endpoint (Class I) and Media Endpoint (Class II) classes, and are extended to include aspects related to end user devices. Example product categories expected to adhere to this class include (but are not limited to) end user communication appliances, such as IP Phones, PC-based softphones, or other communication appliances that directly support the end user.</p> <p>Discovery services defined in this class include provision of location identifier (including ECS / E911 information), embedded L2 switch support, inventory management</p>
<ul style="list-style-type: none"> <li>• <b>LLDP-MED Capabilities</b></li> </ul>	<p>LLDP-MED Capabilities describes the neighbor unit's LLDP-MED capabilities.</p> <p>The possible capabilities are:</p> <ol style="list-style-type: none"> <li>1. LLDP-MED capabilities</li> <li>2. Network Policy</li> <li>3. Location Identification</li> <li>4. Extended Power via MDI - PSE</li> <li>5. Extended Power via MDI - PD</li> <li>6. Inventory</li> <li>7. Reserved</li> </ol>
<ul style="list-style-type: none"> <li>• <b>Application Type</b></li> </ul>	<p>Application Type indicating the primary function of the application(s) defined for this network policy, advertised by an Endpoint or Network Connectivity Device.</p> <p>The possible application types are shown below.</p> <ul style="list-style-type: none"> <li>■ <b>Voice</b> - for use by dedicated IP Telephony handsets and other similar appliances supporting interactive voice services. These devices are typically deployed on a separate VLAN for ease of deployment and enhanced security by isolation from data applications.</li> <li>■ <b>Voice Signaling</b> - for use in network topologies that require a different policy for the voice signaling than for the voice media.</li> <li>■ <b>Guest Voice</b> - to support a separate limited feature-set voice service for guest users and visitors with their own IP Telephony handsets and other similar appliances supporting interactive voice services.</li> <li>■ <b>Guest Voice Signaling</b> - for use in network topologies that require a different</li> </ul>

	<p>policy for the guest voice signaling than for the guest voice media.</p> <ul style="list-style-type: none"> <li>■ <b>Softphone Voice</b> - for use by softphone applications on typical data centric devices, such as PCs or laptops.</li> <li>■ <b>Video Conferencing</b> - for use by dedicated Video Conferencing equipment and other similar appliances supporting real-time interactive video/audio services.</li> <li>■ <b>Streaming Video</b> - for use by broadcast or multicast based video content distribution and other similar applications supporting streaming video services that require specific network policy treatment. Video applications relying on TCP with buffering would not be an intended use of this application type.</li> <li>■ <b>Video Signaling</b> - for use in network topologies that require a separate policy for the video signaling than for the video media.</li> </ul>
• <b>Policy</b>	<p><b>Policy</b> indicates that an Endpoint Device wants to explicitly advertise that the policy is required by the device. Can be either Defined or Unknown</p> <ul style="list-style-type: none"> <li>■ <b>Unknown</b>: The network policy for the specified application type is currently unknown.</li> <li>■ <b>Defined</b>: The network policy is defined.</li> </ul>
• <b>TAG</b>	<p>TAG is indicating whether the specified application type is using a tagged or an untagged VLAN. Can be Tagged or Untagged</p> <ul style="list-style-type: none"> <li>■ <b>Untagged</b>: The device is using an untagged frame format and as such does not include a tag header as defined by IEEE 802.1Q-2003.</li> <li>■ <b>Tagged</b>: The device is using the IEEE 802.1Q tagged frame format</li> </ul>
• <b>VLAN ID</b>	<p>VLAN ID is the VLAN identifier (VID) for the port as defined in IEEE 802.1Q-2003. A value of 1 through 4094 is used to define a valid VLAN ID. A value of 0 (Priority Tagged) is used if the device is using priority tagged frames as defined by IEEE 802.1Q-2003, meaning that only the IEEE 802.1D priority level is significant and the default PVID of the ingress port is used instead.</p>
• <b>Priority</b>	<p>Priority is the Layer 2 priority to be used for the specified application type. One of eight priority levels (0 through 7)</p>
• <b>DSCP</b>	<p>DSCP is the DSCP value to be used to provide Diffserv node behavior for the specified application type as defined in IETF RFC 2474. Contain one of 64 code point values (0 through 63).</p>
• <b>Auto-negotiation</b>	<p><b>Auto-negotiation</b> identifies if MAC/PHY auto-negotiation is supported by the link partner.</p>
• <b>Auto-negotiation status</b>	<p><b>Auto-negotiation status</b> identifies if auto-negotiation is currently enabled at the link partner. If <b>Auto-negotiation</b> is supported and <b>Auto-negotiation status</b> is disabled, the 802.3 PMD operating mode will be determined the operational MAU type field value rather than by auto-negotiation.</p>
• <b>Auto-negotiation</b>	<p><b>Auto-negotiation Capabilities</b> shows the link partners MAC/PHY capabilities.</p>

<b>Capabilities</b>	
---------------------	--

**Buttons**

: Click to refresh the page immediately.

Auto-refresh : Check this box to refresh the page automatically. Automatic refresh occurs every 3 seconds.

**4.3.8.6 Port Statistics**

This page provides an overview of all LLDP traffic. Two types of counters are shown. Global counters are counters that refer to the whole switch, while local counters refers to counters for the currently selected switch. The LLDP Statistics screen in [Figure 4-3-8-5](#) appears.

**LLDP Global Counters**

Global Counters	
Clear global counters	<input checked="" type="checkbox"/>
Neighbor entries were last changed 1970-01-01 Thu 00:00:00+00:00 (86922 secs. ago)	
Total Neighbors Entries Added	0
Total Neighbors Entries Deleted	0
Total Neighbors Entries Dropped	0
Total Neighbors Entries Aged Out	0

**LLDP Statistics Local Counters**

Local Interface	Tx Frames	Rx Frames	Rx Errors	Frames Discarded	TLVs Discarded	TLVs Unrecognized	Org. Discarded	Age-Outs	Clear
*	*	*	*	*	*	*	*	*	<input type="checkbox"/>
1	0	0	0	0	0	0	0	0	<input checked="" type="checkbox"/>
2	0	0	0	0	0	0	0	0	<input checked="" type="checkbox"/>
3	0	0	0	0	0	0	0	0	<input checked="" type="checkbox"/>
4	2	0	0	0	0	0	0	0	<input checked="" type="checkbox"/>
5	0	0	0	0	0	0	0	0	<input checked="" type="checkbox"/>
6	0	0	0	0	0	0	0	0	<input checked="" type="checkbox"/>
7	0	0	0	0	0	0	0	0	<input checked="" type="checkbox"/>
8	0	0	0	0	0	0	0	0	<input checked="" type="checkbox"/>
9	0	0	0	0	0	0	0	0	<input checked="" type="checkbox"/>
10	0	0	0	0	0	0	0	0	<input checked="" type="checkbox"/>
11	0	0	0	0	0	0	0	0	<input checked="" type="checkbox"/>
12	0	0	0	0	0	0	0	0	<input checked="" type="checkbox"/>
13	0	0	0	0	0	0	0	0	<input checked="" type="checkbox"/>
14	0	0	0	0	0	0	0	0	<input checked="" type="checkbox"/>
15	0	0	0	0	0	0	0	0	<input checked="" type="checkbox"/>
16	0	0	0	0	0	0	0	0	<input checked="" type="checkbox"/>
17	0	0	0	0	0	0	0	0	<input checked="" type="checkbox"/>
18	0	0	0	0	0	0	0	0	<input checked="" type="checkbox"/>
19	0	0	0	0	0	0	0	0	<input checked="" type="checkbox"/>
20	0	0	0	0	0	0	0	0	<input checked="" type="checkbox"/>
21	0	0	0	0	0	0	0	0	<input checked="" type="checkbox"/>
22	0	0	0	0	0	0	0	0	<input checked="" type="checkbox"/>
23	0	0	0	0	0	0	0	0	<input checked="" type="checkbox"/>
24	0	0	0	0	0	0	0	0	<input checked="" type="checkbox"/>
25	0	0	0	0	0	0	0	0	<input checked="" type="checkbox"/>
26	0	0	0	0	0	0	0	0	<input checked="" type="checkbox"/>
27	0	0	0	0	0	0	0	0	<input checked="" type="checkbox"/>
28	0	0	0	0	0	0	0	0	<input checked="" type="checkbox"/>

Auto-refresh

**Figure 4-3-8-5: LLDP Statistics Page Screenshot**

The page includes the following fields:

### Global Counters

Object	Description
• <b>Clear global counters</b>	If checked the global counters are cleared when <input type="button" value="Clear"/> is pressed.
• <b>Neighbor entries were last changed</b>	It also shows the time when the last entry was last deleted or added. It also shows the time elapsed since the last change was detected.
• <b>Total Neighbors Entries Added</b>	Shows the number of new entries added since switch reboot.
• <b>Total Neighbors Entries Deleted</b>	Shows the number of new entries deleted since switch reboot.
• <b>Total Neighbors Entries Dropped</b>	Shows the number of LLDP frames dropped due to that the entry table was full.
• <b>Total Neighbors Entries Aged Out</b>	Shows the number of entries deleted due to Time-To-Live expiring.

### LLDP Statistics Local Counters

The displayed table contains a row for each port. The columns hold the following information:

Object	Description
• <b>Local Port</b>	The port on which LLDP frames are received or transmitted.
• <b>Tx Frames</b>	The number of LLDP frames transmitted on the port.
• <b>Rx Frames</b>	The number of LLDP frames received on the port.
• <b>Rx Errors</b>	The number of received LLDP frames containing some kind of error.
• <b>Frames Discarded</b>	If an LLDP frame is received on a port, and the switch's internal table has run full, the LLDP frame is counted and discarded. This situation is known as "Too Many Neighbors" in the LLDP standard. LLDP frames require a new entry in the table when the Chassis ID or Remote Port ID is not already contained within the table. Entries are removed from the table when a given port links down, an LLDP shutdown frame is received, or when the entry ages out.
• <b>TLVs Discarded</b>	Each LLDP frame can contain multiple pieces of information, known as TLVs (TLV is short for "Type Length Value"). If a TLV is malformed, it is counted and discarded.
• <b>TLVs Unrecognized</b>	The number of well-formed TLVs, but with an unknown type value.
• <b>Org. Discarded</b>	The number of organizationally TLVs received.
• <b>Age-Outs</b>	Each LLDP frame contains information about how long time the LLDP information is valid (age-out time). If no new LLDP frame is received within the age out time, the LLDP information is removed, and the <b>Age-Out</b> counter is

---

---

	incremented.
--	--------------

---

---

**Buttons**

 : Click to refresh the page immediately.

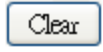
 : Clears the local counters. All counters (including global counters) are cleared upon reboot.

Auto-refresh  Check this box to refresh the page automatically. Automatic refresh occurs every 3 seconds.

### 4.3.9 MAC Address Table

Switching of frames is based upon the DMAC address contained in the frame. The **Industrial Managed Switch** builds up a table that maps MAC addresses to switch ports for knowing which ports the frames should go to (based upon the DMAC address in the frame ). This table contains both static and dynamic entries. The static entries are configured by the network administrator if the administrator wants to do a fixed mapping between the DMAC address and switch ports.

The frames also contain a MAC address (SMAC address ), which shows the MAC address of the equipment sending the frame. The SMAC address is used by the switch to automatically update the MAC table with these dynamic MAC addresses. Dynamic entries are removed from the MAC table if no frame with the corresponding SMAC address have been seen after a configurable age time.

#### 4.3.9.1 MAC Table Configuration

The MAC Address Table is configured on this page. Set timeouts for entries in the dynamic MAC Table and configure the static MAC table here. The MAC Address Table Configuration screen in [Figure 4-3-9-1](#) appears.

### MAC Address Table Configuration

#### Aging Configuration

Disable Automatic Aging	<input type="checkbox"/>
Aging Time	<input type="text" value="300"/> seconds

#### MAC Table Learning

	Port Members																												
	1	2	3	4	5	6	7	8	9	10	11	12	13	14	15	16	17	18	19	20	21	22	23	24	25	26	27	28	
Auto	<input checked="" type="radio"/>	<input checked="" type="radio"/>	<input checked="" type="radio"/>	<input checked="" type="radio"/>	<input checked="" type="radio"/>	<input checked="" type="radio"/>	<input checked="" type="radio"/>	<input checked="" type="radio"/>	<input checked="" type="radio"/>	<input checked="" type="radio"/>	<input checked="" type="radio"/>	<input checked="" type="radio"/>	<input checked="" type="radio"/>	<input checked="" type="radio"/>	<input checked="" type="radio"/>	<input checked="" type="radio"/>	<input checked="" type="radio"/>	<input checked="" type="radio"/>	<input checked="" type="radio"/>	<input checked="" type="radio"/>	<input checked="" type="radio"/>	<input checked="" type="radio"/>	<input checked="" type="radio"/>	<input checked="" type="radio"/>	<input checked="" type="radio"/>	<input checked="" type="radio"/>	<input checked="" type="radio"/>	<input checked="" type="radio"/>	
Disable	<input type="radio"/>	<input type="radio"/>	<input type="radio"/>	<input type="radio"/>	<input type="radio"/>	<input type="radio"/>	<input type="radio"/>	<input type="radio"/>	<input type="radio"/>	<input type="radio"/>	<input type="radio"/>	<input type="radio"/>	<input type="radio"/>	<input type="radio"/>	<input type="radio"/>	<input type="radio"/>	<input type="radio"/>	<input type="radio"/>	<input type="radio"/>	<input type="radio"/>	<input type="radio"/>	<input type="radio"/>	<input type="radio"/>	<input type="radio"/>	<input type="radio"/>	<input type="radio"/>	<input type="radio"/>	<input type="radio"/>	<input type="radio"/>
Secure	<input type="radio"/>	<input type="radio"/>	<input type="radio"/>	<input type="radio"/>	<input type="radio"/>	<input type="radio"/>	<input type="radio"/>	<input type="radio"/>	<input type="radio"/>	<input type="radio"/>	<input type="radio"/>	<input type="radio"/>	<input type="radio"/>	<input type="radio"/>	<input type="radio"/>	<input type="radio"/>	<input type="radio"/>	<input type="radio"/>	<input type="radio"/>	<input type="radio"/>	<input type="radio"/>	<input type="radio"/>	<input type="radio"/>	<input type="radio"/>	<input type="radio"/>	<input type="radio"/>	<input type="radio"/>	<input type="radio"/>	<input type="radio"/>

#### VLAN Learning Configuration

Learnings-disabled VLANs	<input type="text"/>
--------------------------	----------------------

#### Static MAC Table Configuration

	Port Members																													
Delete	VLAN ID	MAC Address	1	2	3	4	5	6	7	8	9	10	11	12	13	14	15	16	17	18	19	20	21	22	23	24	25	26	27	28
<input type="button" value="Add New Static Entry"/>																														
<input type="button" value="Apply"/> <input type="button" value="Reset"/>																														

Figure 4-3-9-1: MAC Address Table Configuration Page Screenshot

The page includes the following fields:

#### Aging Configuration

By default, dynamic entries are removed from the MAC table after 300 seconds. This removal is also called aging.

Object	Description

<ul style="list-style-type: none"> <li>• <b>Disable Automatic Aging</b></li> </ul>	Enables/disables the automatic aging of dynamic entries
<ul style="list-style-type: none"> <li>• <b>Aging Time</b></li> </ul>	The time after which a learned entry is discarded. By default, dynamic entries are removed from the MAC after 300 seconds. This removal is also called aging.  (Range: 10-10000000 seconds; Default: 300 seconds)

### MAC Table Learning

If the learning mode for a given port is grayed out, another module is in control of the mode, so that it cannot be changed by the user. An example of such a module is the MAC-Based Authentication under 802.1X.

Object	Description
<ul style="list-style-type: none"> <li>• <b>Auto</b></li> </ul>	Learning is done automatically as soon as a frame with unknown SMAC is received.
<ul style="list-style-type: none"> <li>• <b>Disable</b></li> </ul>	No learning is done.
<ul style="list-style-type: none"> <li>• <b>Secure</b></li> </ul>	Only static MAC entries are learned, all other frames are dropped.  <b>Note:</b> Make sure that the link used for managing the switch is added to the Static Mac Table before changing to secure learning mode, otherwise the management link is lost and can only be restored by using another non-secure port or by connecting to the switch via the serial interface.

### Static MAC Table Configuration

The static entries in the MAC table are shown in this table. The static MAC table can contain 64 entries. The MAC table is sorted first by VLAN ID and then by MAC address.

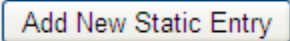
Object	Description
<ul style="list-style-type: none"> <li>• <b>Delete</b></li> </ul>	Check to delete the entry. It will be deleted during the next save.
<ul style="list-style-type: none"> <li>• <b>VLAN ID</b></li> </ul>	The VLAN ID of the entry.
<ul style="list-style-type: none"> <li>• <b>MAC Address</b></li> </ul>	The MAC address of the entry.
<ul style="list-style-type: none"> <li>• <b>Port Members</b></li> </ul>	Checkmarks indicate which ports are members of the entry. Check or uncheck as needed to modify the entry.
<ul style="list-style-type: none"> <li>• <b>Adding a New Static Entry</b></li> </ul>	Click  to add a new entry to the static MAC table. Specify the VLAN ID, MAC address, and port members for the new entry. Click "Save".

### Buttons

 : Click to apply changes

 : Click to undo any changes made locally and revert to previously saved values.



### 4.3.9.2 MAC Address Table Status

#### Dynamic MAC Table

Entries in the MAC Table are shown on this page. The MAC Table contains up to **8192** entries, and is sorted first by VLAN ID, then by MAC address. The MAC Address Table screen in [Figure 4-3-9-2](#) appears.

### MAC Address Table

Start from VLAN  and MAC Address  with  entries per page.

Query by:

<input type="checkbox"/> Interface	CPU ▾
<input type="checkbox"/> VLAN	<input type="text"/>
<input type="checkbox"/> MAC Address	<input type="text"/>

Type	VLAN	MAC Address	Port Members																											
			CPU	1	2	3	4	5	6	7	8	9	10	11	12	13	14	15	16	17	18	19	20	21	22	23	24	25	26	27
Dynamic	1	00-30-4F-33-33-30		✓																										
Static	1	33-33-00-00-00-01	✓	✓	✓	✓	✓	✓	✓	✓	✓	✓	✓	✓	✓	✓	✓	✓	✓	✓	✓	✓	✓	✓	✓	✓	✓	✓	✓	✓
Static	1	33-33-00-00-00-0C		✓																										
Static	1	33-33-00-00-00-FB		✓																										
Static	1	33-33-00-01-00-03		✓																										
Static	1	33-33-FF-BF-CE-03		✓																										
Static	1	33-33-FF-FF-00-01	✓	✓	✓	✓	✓	✓	✓	✓	✓	✓	✓	✓	✓	✓	✓	✓	✓	✓	✓	✓	✓	✓	✓	✓	✓	✓	✓	
Static	1	FF-FF-FF-FF-FF-FF	✓	✓	✓	✓	✓	✓	✓	✓	✓	✓	✓	✓	✓	✓	✓	✓	✓	✓	✓	✓	✓	✓	✓	✓	✓	✓	✓	

Auto-refresh  Refresh Clear << >>

Figure 4-3-9-2: MAC Address Table Status Page Screenshot

#### Navigating the MAC Table

Each page shows up to 999 entries from the MAC table, default being 20, selected through the "entries per page" input field. When first visited, the web page will show the first 20 entries from the beginning of the MAC Table. The first displayed will be the one with the lowest VLAN ID and the lowest MAC address found in the MAC Table.

The "Start from MAC address" and "VLAN" input fields allow the user to select the starting point in the MAC Table. Clicking the "Refresh" button will update the displayed table starting from that or the closest next MAC Table match.

In addition, the two input fields will - upon a "Refresh" button click - assume the value of the first displayed entry, allowing for continuous refresh with the same start address.

The ">>" will use the last entry of the currently displayed VLAN/MAC address pairs as a basis for the next lookup. When the end is reached the text "no more entries" is shown in the displayed table. Use the "<<" button to start over.

The page includes the following fields:

Object	Description
• <b>Type</b>	Indicates whether the entry is a static or dynamic entry.
• <b>VLAN</b>	The VLAN ID of the entry.
• <b>MAC Address</b>	The MAC address of the entry.
• <b>Port Members</b>	The ports that are members of the entry.

### Buttons

Auto-refresh  Automatic refresh occurs every 3 seconds.

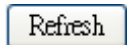

: Refreshes the displayed table starting from the "Start from MAC address" and "VLAN" input fields.



: Flushes all dynamic entries.



: Updates the table starting from the first entry in the MAC Table, i.e. the entry with the lowest VLAN ID and MAC address.



: Updates the table, starting with the entry after the last entry currently displayed.

### 4.3.10 Loop Protection

This chapter describes enabling loop protection function that provides loop protection to prevent broadcast loops in **Industrial Managed Switch**.

#### 4.3.10.1 Configuration

This page allows the user to inspect the current Loop Protection configurations, and possibly change them as well as screen in [Figure 4-3-10-1](#) appears.

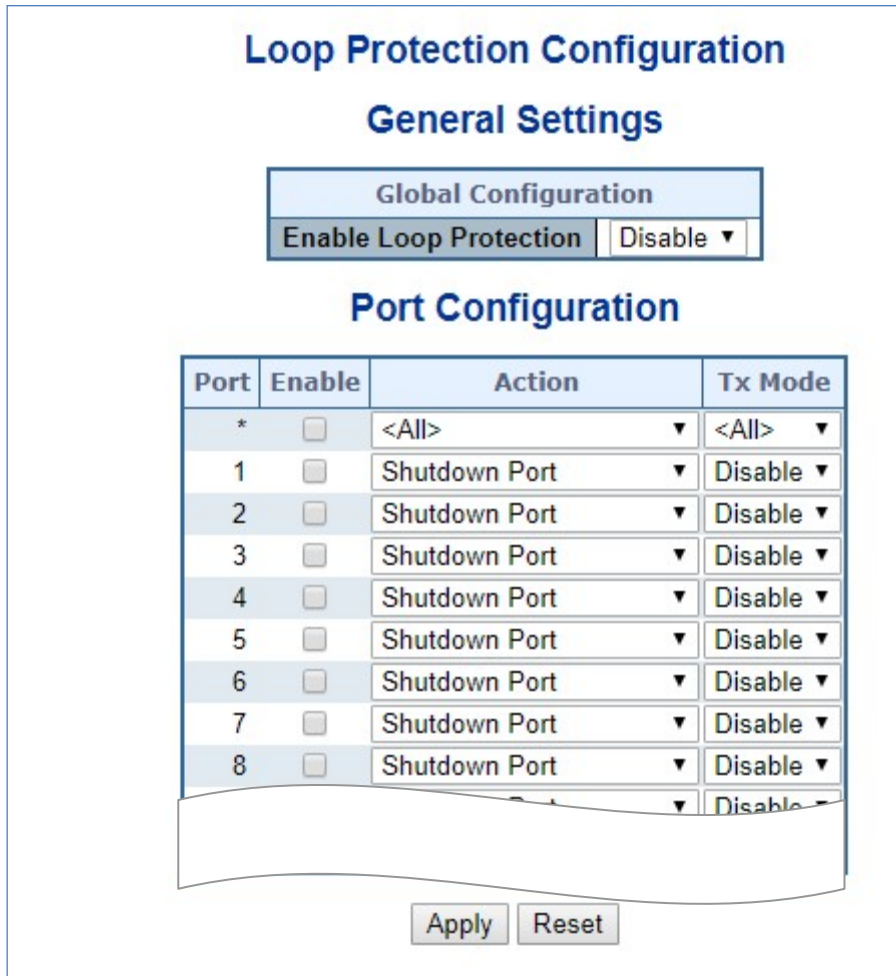

Figure 4-3-10-1: Loop Protection Configuration Page Screenshot

The page includes the following fields:

#### General Settings

Object	Description
<ul style="list-style-type: none"> <li>• <b>Enable Loop Protection</b></li> </ul>	Controls whether loop protection is enabled (as a whole).

#### Port Configuration

Object	Description
--------	-------------

• <b>Port</b>	The switch port number of the port.
• <b>Enable</b>	Controls whether loop protection is enabled on this switch port.
• <b>Action</b>	Configures the action performed when a loop is detected on a port. Valid values are <b>Shutdown Port</b> , <b>Shutdown Port and Log</b> or <b>Log Only</b> .
• <b>Tx Mode</b>	Controls whether the port is actively generating loop protection PDU's, or whether it is just passively looking for looped PDU's.

**Buttons**

 : Click to apply changes

 : Click to undo any changes made locally and revert to previously saved values.

**4.3.10.2 Loop Protection Status**

This page displays the loop protection port status of the switch; screen in [Figure 4-3-10-2](#) appears.



**Figure 4-3-10-2:** Loop Protection Status Screenshot

The page includes the following fields:

Object	Description
• <b>Port</b>	The <b>Industrial Managed Switch</b> port number of the logical port.
• <b>Action</b>	The currently configured port action.
• <b>Transmit</b>	The currently configured port transmit mode.
• <b>Loops</b>	The number of loops detected on this port.
• <b>Status</b>	The current loop protection status of the port.
• <b>Loop</b>	Whether a loop is currently detected on the port.
• <b>Time of Last Loop</b>	The time of the last loop event detected.

**Buttons**

 : Click to refresh the page immediately.

Auto-refresh  : Check this box to enable an automatic refresh of the page at regular intervals.

### 4.3.11 UDLD

Unidirectional Link Detection (UDLD) is a data link layer protocol from Cisco Systems to monitor the physical configuration of the cables and detect unidirectional links. UDLD complements the Spanning Tree Protocol which is used to eliminate switching loops..

#### 4.3.11.1 UDLD Port Configuration

This page allows the user to inspect the current UDLD configurations, and possibly change them as well. as screen in [Figure 4-3-11-1](#) appears.

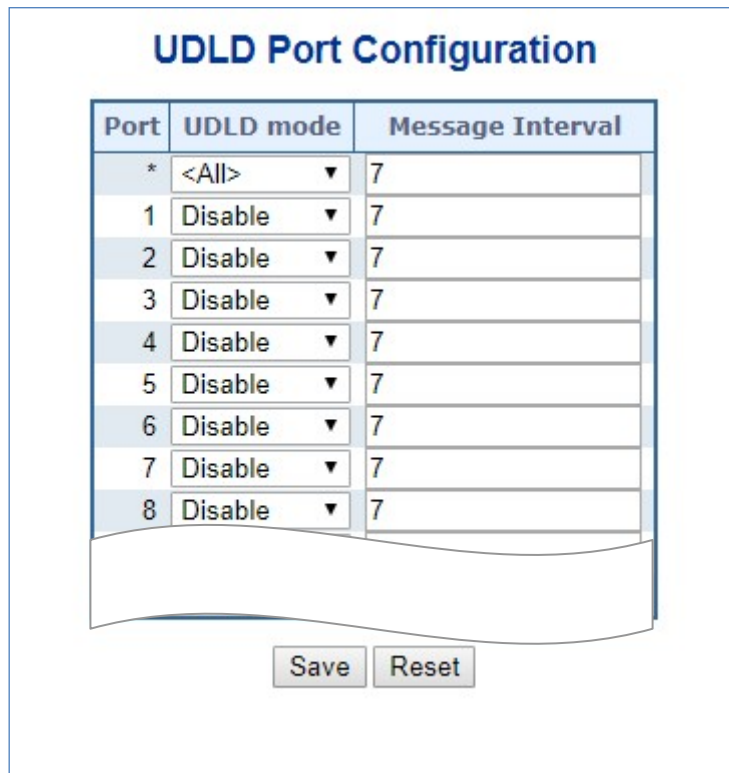

Figure 4-3-11-1: UDLD Configuration Page Screenshot

The page includes the following fields:

#### General Settings

Object	Description
<ul style="list-style-type: none"> <li>Port</li> </ul>	Port number of the switch.
<ul style="list-style-type: none"> <li>UDLD Mode</li> </ul>	<p>Configures the <a href="#">UDLD</a> mode on a port. Valid values are <b>Disable</b>, <b>Normal</b> and <b>Aggressive</b>. Default mode is Disable.</p> <p><b>Disable</b>: In disabled mode, UDLD functionality doesn't exists on port..</p> <p><b>Normal</b>: In normal mode, if the link state of the port was determined to be unidirectional, it will not affect the port state.</p> <p><b>Aggressive</b>: In aggressive mode, unidirectional detected ports will get</p>

	shutdown. To bring back the ports up, need to disable <a href="#">UDLD</a> on that port
<ul style="list-style-type: none"> <li>• <b>Message Interval</b></li> </ul>	Configures the period of time between <a href="#">UDLD</a> probe messages on ports that are in the advertisement phase and are determined to be bidirectional. The range is from 7 to 90 seconds(Default value is 7 seconds)(Currently default time interval is supported, due to lack of detailed information in RFC 5171).

**Buttons**

: Click to apply changes

: Click to undo any changes made locally and revert to previously saved values.

**4.3.11.2 UDLD Status**

This page displays the UDLD status of the ports as well. as screen in [Figure 4-3-11-2](#) appears.

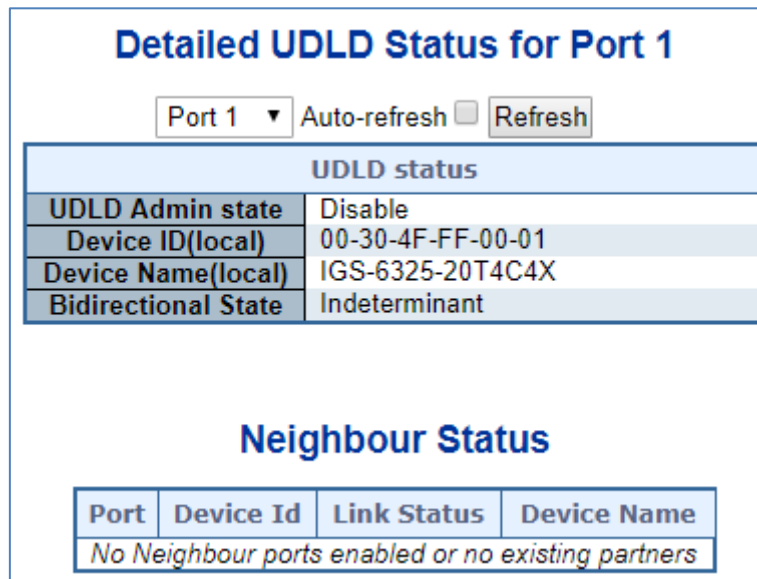

**Figure 4-3-11-2:** UDLD status Page Screenshot

The page includes the following fields:

**UDLD port status**

Object	Description
<ul style="list-style-type: none"> <li>• <b>UDLD Admin State</b></li> </ul>	The current port state of the logical port, Enabled if any of state(Normal,Aggressive) is Enabled.
<ul style="list-style-type: none"> <li>• <b>Device ID(local)</b></li> </ul>	The ID of Device

• <b>Device Name(local)</b>	Name of the Device.
• <b>Bidirectional State</b>	The current state of the port.

**Neighbour Status**

<b>Object</b>	<b>Description</b>
• <b>Port</b>	The current port of neighbour device
• <b>Device ID</b>	The current ID of neighbour device.
• <b>Link Status</b>	The current link status of neighbour port.
• <b>Device Name</b>	Name of the Neighbour Device.

**Buttons**

: Click to refresh the page immediately..

### 4.3.12 GVRP

GVRP (GARP VLAN Registration Protocol or Generic VLAN Registration Protocol) is a protocol that facilitates control of virtual local area networks (VLANs) within a larger network

#### 4.3.12.1 GVRP Configuration

This page allows you to configure the global GVRP configuration settings that are commonly applied to all GVRP enabled ports. as well. as screen in [Figure 4-3-12-1](#) appears.

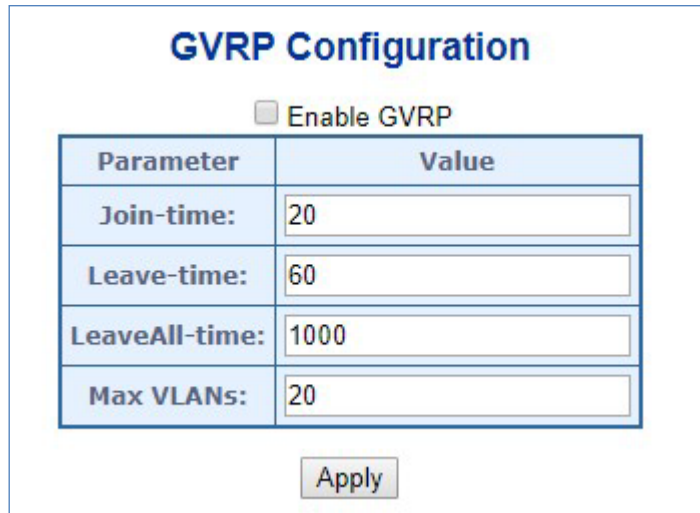

GVRP Configuration	
<input type="checkbox"/> Enable GVRP	
Parameter	Value
Join-time:	20
Leave-time:	60
LeaveAll-time:	1000
Max VLANs:	20
Apply	

Figure 4-3-12-1: GVRP Configuration Page Screenshot

The page includes the following fields:

#### General Settings

Object	Description
<ul style="list-style-type: none"> <li>• <b>Enable GVRP globally</b></li> </ul>	The GVRP feature is globally enabled by setting the check mark in the checkbox named Enable GVRP and pressing the Save button.
<ul style="list-style-type: none"> <li>• <b>GVRP protocol timers</b></li> </ul>	<p>Join-time is a value in the range of 1-20cs, i.e. in units of one hundredth of a second. The default value is 20cs.</p> <p>Leave-time is a value in the range of 60-300cs, i.e. in units of one hundredth of a second. The default is 60cs.</p> <p>LeaveAll-time is a value in the range of 1000-5000cs, i.e. in units of one hundredth of a second. The default is 1000cs</p>
<ul style="list-style-type: none"> <li>• <b>Max number of VLANs</b></li> </ul>	When GVRP is enabled, a maximum number of VLANs supported by GVRP is specified. By default this number is 20. This number can only be changed when GVRP is turned off.



**Buttons**

**Refresh** : Click to refresh the page. Note that unsaved changes will be lost.

**Reset** : Click to undo any changes made locally and revert to previously saved values.

**4.3.12.2 GVRP Port Configuration**

This configuration can be performed either before or after GVRP is configured globally - the protocol operation will be the same. as well. as screen in [Figure 4-3-12-2](#) appears.

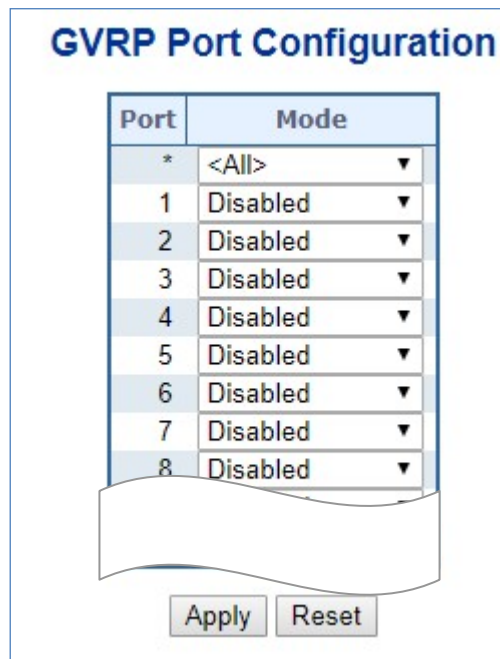

**Figure 4-3-11-2: GVRP Port Configuration Page Screenshot**

The page includes the following fields:

**General Settings**

Object	Description
• <b>Port</b>	The logical port that is to be configured.
• <b>Mode</b>	Mode can be either 'Disabled' or 'GVRP enabled'. These values turn the GVRP feature off or on respectively for the port in question.

**Buttons**

**Apply** : Click to refresh the page. Note that unsaved changes will be lost.

**Reset** : Click to undo any changes made locally and revert to previously saved values.

### 4.3.13 PTP

The **Precision Time Protocol (PTP)** is a protocol used to synchronize clocks throughout a computer network. On a local area network, it achieves clock accuracy in the sub-microsecond range, making it suitable for measurement and control systems.

## Time Synchronization in Network

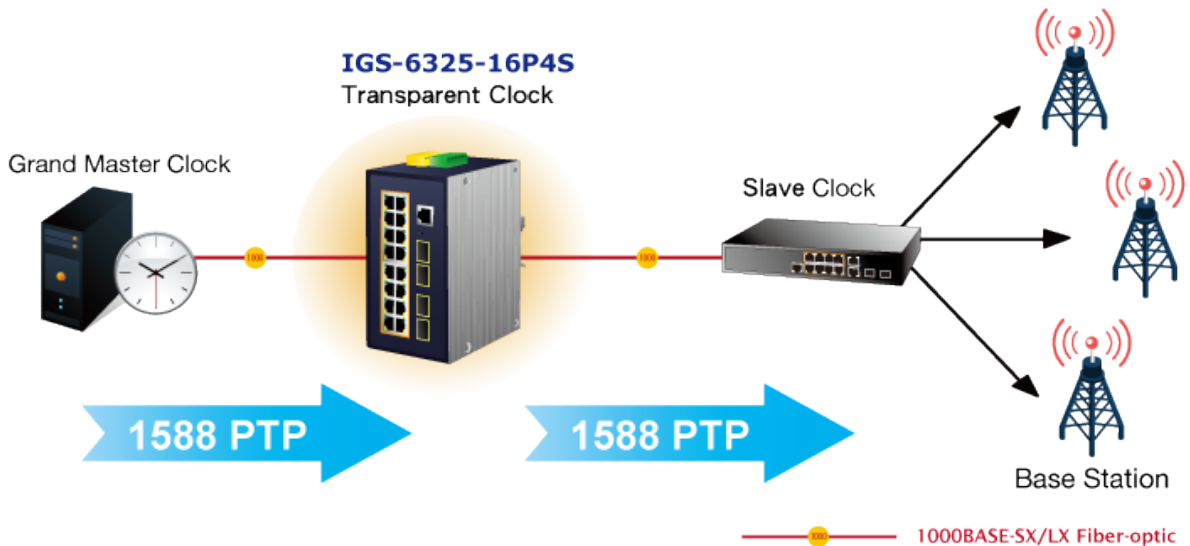

PTP was originally defined in the **IEEE 1588-2002** standard, officially entitled "*Standard for a Precision Clock Synchronization Protocol for Networked Measurement and Control Systems*" and published in 2002. In 2008 a revised standard, **IEEE 588-2008** was released. This new version, also known as PTP Version 2, improves accuracy, precision and robustness but is not backwards compatible with the original 2002 version.

"IEEE 1588 is designed to fill a niche not well served by either of the two dominant protocols, **NTP** and **GPS**. IEEE 1588 is designed for local systems requiring accuracies beyond those attainable using NTP. It is also designed for applications that cannot bear the cost of a GPS receiver at each node, or for which GPS signals are inaccessible"

### 4.3.13.1 PTP Configuration

This page allows the user to configure and inspect the current PTP clock settings as screen in [Figure 4-3-12-1](#) appears.

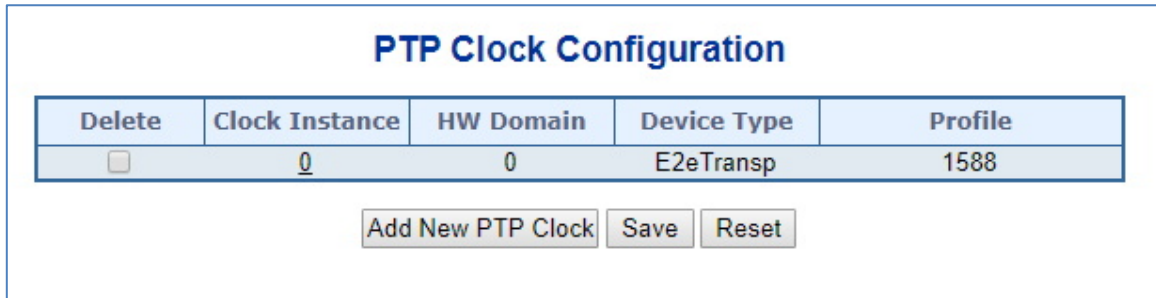

Figure 4-3-13-1: PTP Configuration Page Screenshot

Object	Description
• <b>Delete</b>	Check this box and click on 'Save' to delete the clock instance.
• <b>Clock Instance</b>	Indicates the Instance of a particular Clock Instance [0..3]. Click on the Clock Instance number to edit the Clock details
• <b>HW Domain</b>	Indicates the HW clock domain used by the clock.
• <b>Device Type</b>	Indicates the Type of the Clock Instance. There are five Device Types. <ul style="list-style-type: none"> <li>■ <b>P2p Transp</b> - clock's Device Type is Peer to Peer Transparent Clock.</li> <li>■ <b>E2e Transp</b> - clock's Device Type is End to End Transparent Clock.</li> </ul>
• <b>Profile</b>	Indicates the profile used by the clock.

Click "**Add New PTP Clock**" to create a new clock instance

Click on the **Clock Instance number** to edit the Clock details

### PTP Clock's Configuration and Status

Clock Type and Profile						
Clock Instance	HW Domain	Device Type	Profile	Apply Profile Defaults	Filter Type	
0	0	E2eTransp	1588	Apply	ACI_BASIC_PHASE_LOW ▼	

Port Enable and Configuration											
Port Enable										Configuration	
1	2	3	4	5	6	7	8	9	10	<b>Ports Configuration</b>	
<input type="checkbox"/>	<input type="checkbox"/>	<input type="checkbox"/>	<input type="checkbox"/>	<input type="checkbox"/>	<input type="checkbox"/>	<input type="checkbox"/>	<input type="checkbox"/>	<input type="checkbox"/>	<input type="checkbox"/>		

Virtual Port Enable and Configuration							
Enable	I/O Pin	Class	Accuracy	Variance	Pri1	Pri2	Local Prio
False ▼	0	248	254	65535	128	128	128

Local Clock Current Time		
PTP Time	Clock Adjustment method	Synchronize to System Clock
1970-01-01 Thu 03:41:03+00:00 806,497,060	Internal Timer	Synchronize to System Clock

**Clock Current Data Set**

stpRm	Offset From Master	Mean Path Delay
0	0.000,000,000	0.000,000,000

**Clock Parent Data Set**

Parent Port ID	port	PStat	Var	Rate	GrandMaster ID	GrandMaster Clock Quality	Pri1	Pri2
a8:f7:00:ff:fe:00:12:34	0	False	0	0	a8:f7:00:ff:fe:00:12:34	Cl:248 Ac:Unknwn Va:65535	128	128

**Clock Default Data Set**

Device Type	One-Way	2 Step Flag	Ports	Clock Identity	Dom	Clock Quality
E2eTransp	False ▼	False ▼	10	a8:f7:00:ff:fe:00:12:34	0	Cl:248 Ac:Unknwn Va:65535
Pri1	Pri2	Local Prio	Protocol	VID	PCP	DSCP
128	128	128	Ethernet ▼	1	0 ▼	0

**Clock Time Properties Data Set**

UtcOffset	Valid	leap59	leap61	Time Trac	Freq Trac	ptp Time Scale	Time Source
0	False ▼	False ▼	False ▼	False ▼	False ▼	True ▼	160
Leap Pending		Leap Date			Leap Type		
False ▼		1970-01-01			leap61 ▼		

The page includes the following fields:

### Clock Type and Profile

**Clock Type and Profile**

Clock Instance	HW Domain	Device Type	Profile	Apply Profile Defaults	Filter Type
0	0	E2eTransp	1588	<input type="button" value="Apply"/>	ACI_BASIC_PHASE_LOW ▼

Object	Description
<ul style="list-style-type: none"> <li><b>Clock Instance</b></li> </ul>	Indicates the instance number of a particular Clock Instance [0..3].
<ul style="list-style-type: none"> <li><b>HW Domain</b></li> </ul>	Indicates the HW clock domain used by the clock.
<ul style="list-style-type: none"> <li><b>Device Type</b></li> </ul>	Indicates the Type of the Clock Instance. There are two Device Types. <ul style="list-style-type: none"> <li>■ <b>P2p Transp</b> - clock's Device Type is Peer to Peer Transparent Clock.</li> <li>■ <b>E2e Transp</b> - clock's Device Type is End to End Transparent Clock.</li> </ul>
<ul style="list-style-type: none"> <li><b>Profile</b></li> </ul>	Indicates the profile used by the clock.
<ul style="list-style-type: none"> <li><b>Apply Profile Defaults</b></li> </ul>	If the clock has been configured to use a profile, clicking the 'Apply' button will reset configured values to profile defaults.
<ul style="list-style-type: none"> <li><b>Filter Type</b></li> </ul>	The PTP filter type determines should match the operating conditions of the network and the PTP profile.

Filter Types			
PTP Profile	SyncE enabled(hybrid)	Filter type	Description
1588	No	ACI_BASIC_PHASE	Requires PTP Sync and Delay_req frame rate of 16 fps or higher.
1588	Yes	ACI_BASIC_PHASE_SYNCE	Requires PTP Sync and Delay_req frame rate of 16 fps or higher.
1588	No	ACI_BASIC_PHASE_LOW	Use when the PTP Sync and Delay_req frame rate is between 1 fps to 16 fps.
1588	Yes	ACI_BASIC_PHASE_LOW_SYNCE	Use when the PTP Sync and Delay_req frame rate is between 1 fps to 16 fps.
None	No	ACI_BC_FULL_ON_PATH_FREQ	Used for Syntonized TC with basic filter.

### Port Enable and Configuration

Port Enable and Configuration											
Port Enable										Configuration	
1	2	3	4	5	6	7	8	9	10	<b>Ports Configuration</b>	
<input type="checkbox"/>	<input type="checkbox"/>	<input type="checkbox"/>	<input type="checkbox"/>	<input type="checkbox"/>	<input type="checkbox"/>	<input type="checkbox"/>	<input type="checkbox"/>	<input type="checkbox"/>	<input type="checkbox"/>		

Object	Description
• Port Enable	Set check mark for each port configured for this Clock Instance.
• Configuration	Click ' <b>Ports Configuration</b> ' to edit the port data set for the ports assigned to this clock instance.

The port data set is defined in the IEEE 1588 Standard. It holds three groups of data: the static members, the dynamic members, and configurable members which can be set here.

#### PTP Clock's Port Data Set Configuration

Port	Stat	MDR	PeerMeanPathDel	Anv	ATo	Syv	DIm	MPR	Delay Asymmetry	Ingress Latency	Egress Latency	Version	Mcast Addr	Not Slave	Local Prio	2 Step Flag
1	dsbl	0	0.000,000,000	1	3	0	e2e ▼	0	0	0	0	2	Default ▼	False ▼	128	Clock Def. ▼
2	dsbl	0	0.000,000,000	1	3	0	e2e ▼	0	0	0	0	2	Default ▼	False ▼	128	Clock Def. ▼

Apply Reset

### Port Data Set

Object	Description
• Port	Static member port Identity : Port number [1..max port no]
• Stat	Dynamic member portState: Current state of the port.
• MDR	Dynamic member log Min Delay Req Interval: The delay request interval announced by the master.
• Peer Mean Path Del	The path delay measured by the port in P2P mode. In E2E mode this value is 0
• Anv	The interval for issuing announce messages in master state. Range is -3 to 4.
• ATo	The timeout for receiving announce messages on the port. Range is 1 to 10.
• Syv	The interval for issuing sync messages in master. Range is -7 to 4.

<ul style="list-style-type: none"> <li>• <b>Dim</b></li> </ul>	<p>Configurable member delayMechanism:          The delay mechanism used for the port:          e2e End to end delay measurement          p2p Peer to peer delay measurement.          Can be defined per port in an Ordinary/Boundary clock.          In a transparent clock all ports use the same delay mechanism, determined by the clock type.</p>
<ul style="list-style-type: none"> <li>• <b>MPR</b></li> </ul>	<p>The interval for issuing Delay_Req messages for the port in <b>E2e</b> mode.          This value is announced from the master to the slave in an announce message.          The value is reflected in the MDR field in the Slave          The interval for issuing Pdelay_Req messages for the port in P2P mode          Range is -7 to 5.  <b>Note:</b>          The interpretation of this parameter has changed from release 2.40. In earlier versions the value was interpreted relative to the Sync interval, this was a violation of the standard, so now the value is interpreted as an interval. I.e. MPR=0 =&gt; 1 Delay_Req pr sec, independent of the Sync rate.</p>
<ul style="list-style-type: none"> <li>• <b>Delay Asymmetry</b></li> </ul>	<p>If the transmission delay for a link is not symmetric, the asymmetry can be configured here, see IEEE 1588 Section 7.4.2 Communication path asymmetry          Range is -100000 to 100000.          Version          The current implementation only supports PTP version 2</p>
<ul style="list-style-type: none"> <li>• <b>Ingress latency</b></li> </ul>	<p>Ingress latency measured in ns, as defined in IEEE 1588 Section 7.3.4.2.          Range is -100000 to 100000.</p>
<ul style="list-style-type: none"> <li>• <b>Egress Latency</b></li> </ul>	<p>Egress latency measured in ns, as defined in IEEE 1588 Section 7.3.4.2.          Range is -100000 to 100000.</p>
<ul style="list-style-type: none"> <li>• <b>Version</b></li> </ul>	<p>PTP version used by this port</p>
<ul style="list-style-type: none"> <li>• <b>Mcast Addr</b></li> </ul>	<p>Configured destination address for multicast packets (PTP default or LinkLocal)</p>
<ul style="list-style-type: none"> <li>• <b>Not Slave</b></li> </ul>	<p>TRUE indicates that this interface cannot enter slave mode</p>
<ul style="list-style-type: none"> <li>• <b>Local Prio</b></li> </ul>	<p>1-255, priority used in the 8275.1 BMCA</p>
<ul style="list-style-type: none"> <li>• <b>2 Step Flag</b></li> </ul>	<p>Option to override the 2-step option on port level */ // <b>IEEE 802.1AS</b> specific parameters are only available when the 802.1AS profile is selected</p>

### Virtual Port Enable and Configuration

Virtual Port Enable and Configuration

Enable	I/O Pin	Class	Accuracy	Variance	Pri1	Pri2	Local Prio
False ▾	0	248	254	65535	128	128	128

Object	Description
• Enable	Disabled or Enabled.
• I/O Pin	Virtual Port I/O Pin. The valid range is 0 to 3.
• Class	Clock class value for clock as defined in IEEE Std 1588. The valid range is from 0 to 255.
• Accuracy	Clock accuracy value as defined in IEEE Std 1588. The valid range is 0 to 255.
• Variance	offsetScaledLogVariance for clock as defined in IEEE Std 1588. The valid range is 0 to 65535.
• Pri1	Clock priority 1 [0..255] used by the BMC master select algorithm.
• Pri2	Clock priority 2 [0..255] used by the BMC master select algorithm.
• Local Prio	Priority [1..255] used in the 8275.1 BMCA.

### Local Clock Current Time

Local Clock Current Time

PTP Time	Clock Adjustment method	Synchronize to System Clock
1970-01-01 Thu 03:41:03+00:00 806,497,060	Internal Timer	<input type="button" value="Synchronize to System Clock"/>

Object	Description
• PTP Time	Shows the actual PTP time with nanosecond resolution.
• Clock Adjustment Method	Shows the actual clock adjustment method. The method depends on the available hardware.
• Synchronize to System Clock	Activate this button to synchronize the System Clock to PTP Time.

### Clock current Data Set

Clock Current DataSet

stpRm	Offset From Master	Mean Path Delay
0	0.000,000,000	0.000,000,000

Object	Description
• <b>stpRm</b>	Steps Removed : It is the number of PTP clocks traversed from the grandmaster to the local slave clock.
• <b>Offset from master</b>	Time difference between the <b>master clock</b> and the <b>local slave clock</b> , measured in <b>ns</b> .
• <b>Mean Path Delay</b>	The mean propagation time for the link between the <b>master</b> and the <b>local slave</b>

### Clock Parent Data Set

The clock parent data set is defined in the IEEE 1588 standard. The parent data set is dynamic.

Clock Parent DataSet

Parent Port ID	port	PStat	Var	Rate	GrandMaster ID	GrandMaster Clock Quality	Pri1	Pri2
a8:f7:00:ff:fe:00:12:34	0	False	0	0	a8:f7:00:ff:fe:00:12:34	Cl:248 Ac:Unknwn Va:65535	128	128

Object	Description
• <b>Parent Port Identity</b>	Clock identity for the parent clock, if the local clock is not a slave, the value is the clocks own id.
• <b>Port</b>	Port Id for the parent master port
• <b>P Stat</b>	Parents Stats (always false).
• <b>Var</b>	It is observed parent offset scaled log variance
• <b>Rate</b>	Observed Parent Clock Phase Change Rate. i.e. the slave clocks rate offset compared to the master. (unit = ns per s).
• <b>Grand Master ID</b>	Clock identity for the grand master clock, if the local clock is not a slave, the value is the clocks own id.
• <b>Grand Master Clock Quality</b>	The clock quality announced by the grand master (See description of Clock Default Data Set: Clock Quality)
• <b>Pri1</b>	Clock priority 1 announced by the grand master
• <b>Pri2</b>	Clock priority 2 announced by the grand master



### Clock Default Data Set

The clock default data set is defined in the IEEE 1588 Standard. It holds three groups of data: the static members defined at clock creation time, the Dynamic members defined by the system, and the configurable members which can be set here.

Clock Default DataSet							
Device Type	One-Way	2 Step Flag	Ports	Clock Identity	Dom	Clock Quality	
E2eTransp	False ▼	False ▼	10	a8:f7:00:ff:fe:00:12:34	0	Cl:248 Ac:Unknwn Va:65535	
Pri1	Pri2	Local Prio	Protocol		VID	PCP	DSCP
128	128	128	Ethernet ▼		1	0 ▼	0

Object	Description
<ul style="list-style-type: none"> <li>• <b>Device Type</b></li> </ul>	<p>Indicates the Type of the Clock Instance. There are five Device Types.</p> <ul style="list-style-type: none"> <li>■ <b>P2p Transp</b> - clock's Device Type is Peer to Peer Transparent Clock.</li> <li>■ <b>E2e Transp</b> - clock's Device Type is End to End Transparent Clock.</li> </ul>
<ul style="list-style-type: none"> <li>• <b>One-Way</b></li> </ul>	<p>If true, one way measurements are used.</p> <p>This parameter applies only to a slave. In one-way mode no delay measurements are performed, i.e. this is applicable only if frequency synchronization is needed.</p> <p>The master always responds to delay requests.</p>
<ul style="list-style-type: none"> <li>• <b>2 Step Flag</b></li> </ul>	<p>Static member: defined by the system, true if two-step Sync events and Pdelay_Resp events are used</p>
<ul style="list-style-type: none"> <li>• <b>Ports</b></li> </ul>	<p>The total number of physical ports in the node</p>
<ul style="list-style-type: none"> <li>• <b>Clock Identity</b></li> </ul>	<p>It shows unique clock identifier</p>
<ul style="list-style-type: none"> <li>• <b>Dom</b></li> </ul>	<p>Clock domain [0..127].</p>
<ul style="list-style-type: none"> <li>• <b>Clock Quality</b></li> </ul>	<p>The clock quality is determined by the system, and holds 3 parts: <b>Clock Class</b>, <b>Clock Accuracy</b> and <b>OffsetScaledLog Variance</b> as defined in IEEE1588.</p> <p>The Clock Accuracy values are defined in IEEE1588 table 6 (Currently the clock Accuracy is set to 'Unknown' as default).</p>
<ul style="list-style-type: none"> <li>• <b>Pri1</b></li> </ul>	<p>Clock priority 1 [0..255] used by the BMC master select algorithm.</p>
<ul style="list-style-type: none"> <li>• <b>Pri2</b></li> </ul>	<p>Clock priority 2 [0..255] used by the BMC master select algorithm.</p>
<ul style="list-style-type: none"> <li>• <b>Local Prio</b></li> </ul>	<p>Priority [1..255] used in the 8275.1 BMCA.</p>
<ul style="list-style-type: none"> <li>• <b>Protocol</b></li> </ul>	<p>Transport protocol used by the PTP protocol engine</p> <ul style="list-style-type: none"> <li>■ <b>Ethernet</b> PTP over Ethernet multicast</li> <li>■ <b>EthernetMixed</b> PTP using a combination of Ethernet multicast and unicast</li> <li>■ <b>IPv4Multi</b> PTP over IPv4 multicast</li> <li>■ <b>IPv4Mixed</b> PTP using a combination of IPv4 multicast and unicast</li> <li>■ <b>IPv4Uni</b> PTP over IPv4 unicast</li> </ul>

• VID	VLAN Identifier used for tagging the VLAN packets.
• PCP	Priority Code Point value used for PTP frames.
• DSCP	DSCP value used when transmitting IPv4 encapsulated packets

### Clock Time Properties Data Set

The clock time properties data set is defined in the IEEE 1588 Standard. The data set is both configurable and dynamic, i.e. the parameters can be configured for a grandmaster. In a slave clock the parameters are overwritten by the grandmasters timing properties. The parameters are not used in the current PTP implementation.

The valid values for the Time Source parameter are:

- 16 (0x10) ATOMIC\_CLOCK
- 32 (0x20) GPS
- 48 (0x30) TERRESTRIAL\_RADIO
- 64 (0x40) PTP
- 80 (0x50) NTP
- 96 (0x60) HAND\_SET
- 144 (0x90) OTHER
- 160 (0xA0) INTERNAL\_OSCILLATOR

Clock Time Properties Data Set

UtcOffset	Valid	leap59	leap61	Time Trac	Freq Trac	ptp Time Scale	Time Source
0	False ▼	False ▼	False ▼	False ▼	False ▼	True ▼	160
Leap Pending		Leap Date			Leap Type		
False ▼		1970-01-01			leap61 ▼		

Object	Description
• UtcOffset	In systems whose epoch is UTC, it is the offset between TAI and UTC
• Valid	When true, the value of currentUtcOffset is valid
• leap59	When true, this field indicates that last minute of the current UTC day has only 59 seconds.
• leap61	When true, this field indicates that last minute of the current UTC day has 61 seconds.
• Time Trac	True if the timescale and the value of currentUtcOffset are traceable to a primary reference.
• Freq Trac	True if the frequency determining the timescale is traceable to a primary reference.
• ptp Time Scale	True if the clock timescale of the grandmaster clock and false otherwise.
• Time Source	The source of time used by the grandmaster clock.

<ul style="list-style-type: none"><li>• <b>Leap Pending</b></li></ul>	When true, there is a leap event pending at the date defined by leapDate.
<ul style="list-style-type: none"><li>• <b>Leap Date</b></li></ul>	The date for which the leap will occur at the end of its last minute. Date is represented as the number of days after 1970-01-01 (the latter represented as 0).
<ul style="list-style-type: none"><li>• <b>Leap Type</b></li></ul>	The type of leap event i.e. leap59 or leap61.

### 4.3.14 Link OAM

#### 4.3.14.1 Statistics

This page provides detailed OAM traffic statistics for a specific switch port. Use the port select box to select which switch port details to display. The displayed counters represent the total number of OAM frames received and transmitted for the selected port. Discontinuities of these counter can occur at re-initialization of the management system, as screen in [Figure 4-3-14-1](#) appears.

Detailed Link OAM Statistics for Port 1			
Port 1 ▾		Auto-refresh <input type="checkbox"/>	<input type="button" value="Refresh"/> <input type="button" value="Clear"/>
Receive Total		Transmit Total	
Rx OAM Information PDU's	0	Tx OAM Information PDU's	0
Rx Unique Error Event Notification	0	Tx Unique Error Event Notification	0
Rx Duplicate Error Event Notification	0	Tx Duplicate Error Event Notification	0
Rx Loopback Control	0	Tx Loopback Control	0
Rx Variable Request	0	Tx Variable Request	0
Rx Variable Response	0	Tx Variable Response	0
Rx Org Specific PDU's	0	Tx Org Specific PDU's	0
Rx Unsupported Codes	0	Tx Unsupported Codes	0
Rx Link Fault PDU's	0	Tx Link Fault PDU's	0
Rx Dying Gasp	0	Tx Dying Gasp	0
Rx Critical Event PDU's	0	Tx Critical Event PDU's	0

Figure 4-3-14-1: Link OAM Statistic Page Screenshot

The page includes the following fields:

#### General Settings

Object	Description
<ul style="list-style-type: none"> <li>Rx and Tx OAM Information PDU's</li> </ul>	The number of received and transmitted OAM Information PDU's. Discontinuities of this counter can occur at re-initialization of the management system.
<ul style="list-style-type: none"> <li>Rx and Tx Unique Error Event Notification</li> </ul>	<p>A count of the number of unique Event OAMPDUs received and transmitted on this interface. Event Notifications may be sent in duplicate to increase the probability of successfully being received, given the possibility that a frame may be lost in transit. Duplicate Event Notification transmissions are counted by Duplicate Event Notification counters for Tx and Rx respectively.</p> <p>A unique Event Notification OAMPDU is indicated as an Event Notification OAMPDU with a Sequence Number field that is distinct from the previously transmitted Event Notification OAMPDU Sequence Number.</p>
<ul style="list-style-type: none"> <li>Rx and Tx Duplicate Error Event Notification</li> </ul>	A count of the number of duplicate Event OAMPDUs received and transmitted on this interface. Event Notification OAMPDUs may be sent in duplicate to increase the probability of successfully being received, given the possibility that a frame may be lost in transit.

	A duplicate Event Notification OAMPDU is indicated as an Event Notification OAMPDU with a Sequence Number field that is identical to the previously transmitted Event Notification OAMPDU Sequence Number.
• <b>Rx and Tx Loopback Control</b>	A count of the number of Loopback Control OAMPDUs received and transmitted on this interface.
• <b>Rx and Tx Variable Request</b>	A count of the number of Variable Request OAMPDUs received and transmitted on this interface.
• <b>Rx and Tx Variable Response</b>	A count of the number of Variable Response OAMPDUs received and transmitted on this interface.
• <b>Rx and Tx Org Specific PDU's</b>	A count of the number of Organization Specific OAMPDUs transmitted on this interface.
• <b>Rx and Tx Unsupported Codes</b>	A count of the number of OAMPDUs transmitted on this interface with an unsupported op-code.
• <b>Rx and Tx Link fault PDU's</b>	A count of the number of Link fault PDU's received and transmitted on this interface.
• <b>Rx and Tx Dying Gasp</b>	A count of the number of Dying Gasp events received and transmitted on this interface.
• <b>Rx and Tx Critical Event PDU's</b>	A count of the number of Critical event PDU's received and transmitted on this interface.

**Buttons**

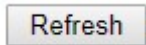
: Click to refresh the page immediately.

: Clears the counters for the selected port.

### 4.3.14.2 Port Status

This page provides Link OAM configuration operational status. The displayed fields shows the active configuration status for the selected port. as well. as screen in [Figure 4-3-14-2](#) appears.

#### Detailed Link OAM Status for Port 1

Port 1 ▾ Auto-refresh  Refresh

PDU Permission	Receive only
Discovery State	Fault state
Peer MAC Address	-----

Local		Peer	
Mode	Passive	Mode	-----
Unidirectional Operation Support	Disabled	Unidirectional Operation Support	-----
Remote Loopback Support	Disabled	Remote Loopback Support	-----
Link Monitoring Support	Enabled	Link Monitoring Support	-----
MIB Retrieval Support	Disabled	MIB Retrieval Support	-----
MTU Size	1500	MTU Size	-----
Multiplexer State	Forwarding	Multiplexer State	-----
Parser State	Forwarding	Parser State	-----
Organizational Unique Identification	a8-f7-e0	Organizational Unique Identification	-----
PDU Revision	0	PDU Revision	-----

Figure 4-3-14-2: Port Status Page Screenshot

The page includes the following fields:

#### General Settings

Object	Description
<ul style="list-style-type: none"> <li>• <b>PDU Permission</b></li> </ul>	<p>This field is available only for the Local DTE.</p> <p>It displays the current permission rules set for the local DTE. Possible values are</p> <ul style="list-style-type: none"> <li>■ <b>Link fault</b></li> <li>■ <b>Receive only</b></li> <li>■ <b>Information exchange only</b></li> <li>■ <b>ANY</b></li> </ul>
<ul style="list-style-type: none"> <li>• <b>Discovery State</b></li> </ul>	<p>Displays the current state of the discovery process.</p> <p>Possible states are</p> <ul style="list-style-type: none"> <li>■ <b>Fault state</b></li> <li>■ <b>Active state</b></li> <li>■ <b>Passive state</b></li> <li>■ <b>SEND_LOCAL_REMOTE_STATE</b></li> <li>■ <b>SEND_LOCAL_REMOTE_OK_STATE</b></li> <li>■ <b>SEND_ANY_STATE</b></li> </ul>
<ul style="list-style-type: none"> <li>• <b>Mode</b></li> </ul>	<p>The Mode in which the Link OAM is operating, Active or Passive.</p>
<ul style="list-style-type: none"> <li>• <b>Unidirectional</b></li> </ul>	<p>This feature is not available to be configured by the user. The status of this</p>

<b>Operation Support</b>	configuration is retrieved from the PHY.
• <b>Remote Loopback Support</b>	If status is enabled, DTE is capable of OAM remote loopback mode.
• <b>Link Monitoring Support</b>	If status is enabled, DTE supports interpreting Link Events.
• <b>MIB Retrieval Support</b>	If status is enabled DTE supports sending Variable Response OAMPDUs.
• <b>MTU Size</b>	It represents the largest OAMPDU, in octets, supported by the DTE. This value is compared to the remote's Maximum PDU Size and the smaller of the two is used.
• <b>Multiplexer State</b>	When in forwarding state, the Device is forwarding non-OAMPDUs to the lower sublayer. In case of discarding, the device discards all the non-OAMPDU's.
• <b>Parser State</b>	When in <b>forwarding</b> state, Device is forwarding non-OAMPDUs to higher sublayer. When in <b>loopback</b> , Device is looping back non-OAMPDUs to the lower sublayer. When in <b>discarding</b> state, Device is discarding non-OAMPDUs.
• <b>Organizational Unique Identification</b>	24-bit Organizationally Unique Identifier of the vendor.
• <b>PDU Revision</b>	It indicates the current revision of the Information TLV. The value of this field shall start at zero and be incremented each time something in the Information TLV changes. Upon reception of an Information TLV from a peer, an OAM client may use this field to decide if it needs to be processed (an Information TLV that is identical to the previous Information TLV doesn't need to be parsed as nothing in it has changed).

**Buttons**

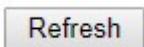
 : Click to refresh the page immediately.

Auto-refresh  : Check this box to enable an automatic refresh. Automatic refresh occurs every 3 seconds.



### 4.3.14.3 Event Status

This page allows the user to inspect the current Link OAM Link Event configurations, and change them as well. as screen in [Figure 4-3-14-3](#) appears.

Detailed Link OAM Link Status for Port 1			
Port 1		Auto-refresh	Refresh
Local Frame Error Status		Remote Frame Error Status	
Sequence Number	0	Frame Error Event Timestamp	0
Frame Error Event Timestamp	0	Frame error event window	0
Frame error event window	0	Frame error event threshold	0
Frame error event threshold	0	Frame errors	0
Frame errors	0	Total frame errors	0
Total frame errors	0	Total frame error events	0
Total frame error events	0		
Local Frame Period Status		Remote Frame Period Status	
Frame Period Error Event Timestamp	0	Frame Period Error Event Timestamp	0
Frame Period Error Event Window	0	Frame Period Error Event Window	0
Frame Period Error Event Threshold	0	Frame Period Error Event Threshold	0
Frame Period Errors	0	Frame Period Errors	0
Total frame period errors	0	Total frame period errors	0
Total frame period error events	0	Total frame period error events	0
Local Symbol Period Status		Remote Symbol Period Status	
Symbol Period Error Event Timestamp	0	Symbol Period Error Event Timestamp	0
Symbol Period Error Event Window	0	Symbol Period Error Event Window	0
Symbol Period Error Event Threshold	0	Symbol Period Error Event Threshold	0
Symbol Period Errors	0	Symbol Period Errors	0
Total symbol period errors	0	Total symbol period errors	0
Total Symbol period error events	0	Total Symbol period error events	0
Local Event Seconds Summary Status		Remote Event Seconds Summary Status	
Error Frame Seconds Summary Event Timestamp	0	Error Frame Seconds Summary Event Timestamp	0
Error Frame Seconds Summary Event window	0	Error Frame Seconds Summary Event window	0
Error Frame Seconds Summary Event Threshold	0	Error Frame Seconds Summary Event Threshold	0
Error Frame Seconds Summary Errors	0	Error Frame Seconds Summary Errors	0
Total Error Frame Seconds Summary Errors	0	Total Error Frame Seconds Summary Errors	0
Total Error Frame Seconds Summary Events	0	Total Error Frame Seconds Summary Events	0

Figure 4-3-14-3: Link OAM Statistic Page Screenshot

The page includes the following fields:

#### General Settings

Object	Description
• Port	The switch port number.
• Sequence Number	This two-octet field indicates the total number of events occurred at the remote end.
• Frame Error Event Timestamp	This two-octet field indicates the time reference when the event was generated, in terms of 100 ms intervals.
• Frame error event window	This two-octet field indicates the duration of the period in terms of 100 ms intervals. 1) The default value is one second. 2) The lower bound is one second. 3) The upper bound is one minute.
• Frame error event threshold	This four-octet field indicates the number of detected errored frames in the period is required to be equal to or greater than in order for the event to be generated. 1)



	The default value is one frame error. 2) The lower bound is zero frame errors. 3) The upper bound is unspecified.
• <b>Frame errors</b>	This four-octet field indicates the number of detected errored frames in the period.
• <b>Total frame errors</b>	This eight-octet field indicates the sum of errored frames that have been detected since the OAM sublayer was reset.
• <b>Total frame error events</b>	This four-octet field indicates the number of Errored Frame Event TLVs that have been generated since the OAM sublayer was reset.
• <b>Frame Period Error Event Timestamp</b>	This two-octet field indicates the time reference when the event was generated, in terms of 100 ms intervals.
• <b>Frame Period Error Event Window</b>	This four-octet field indicates the duration of period in terms of frames.
• <b>Frame Period Error Event Threshold</b>	This four-octet field indicates the number of errored frames in the period is required to be equal to or greater than in order for the event to be generated.
• <b>Frame Period Errors</b>	This four-octet field indicates the number of frame errors in the period.
• <b>Total frame period errors</b>	This eight-octet field indicates the sum of frame errors that have been detected since the OAM sublayer was reset.
• <b>Total frame period error events</b>	This four-octet field indicates the number of Errored Frame Period Event TLVs that have been generated since the OAM sublayer was reset
• <b>Symbol Period Error Event Timestamp</b>	This two-octet field indicates the time reference when the event was generated, in terms of 100 ms intervals.
• <b>Symbol Period Error Event Window</b>	This eight-octet field indicates the number of symbols in the period.
• <b>Symbol Period Error Event Threshold</b>	This eight-octet field indicates the number of errored symbols in the period is required to be equal to or greater than in order for the event to be generated.
• <b>Symbol Period Errors</b>	This eight-octet field indicates the number of symbol errors in the period.
• <b>Total symbol period errors</b>	This eight-octet field indicates the sum of symbol errors since the OAM sublayer was reset.
• <b>Total Symbol period error events</b>	This four-octet field indicates the number of Errored Symbol Period Event TLVs that have been generated since the OAM sublayer was reset.
• <b>Error Frame Seconds Summary Event Timestamp</b>	This two-octet field indicates the time reference when the event was generated, in terms of 100 ms intervals, encoded as a 16-bit unsigned integer.
• <b>Error Frame Seconds Summary Event window</b>	This two-octet field indicates the duration of the period in terms of 100 ms intervals, encoded as a 16-bit unsigned integer.
• <b>Error Frame Seconds Summary Event Threshold</b>	This two-octet field indicates the number of errored frame seconds in the period is required to be equal to or greater than in order for the event to be generated, encoded as a 16-bit unsigned integer.

<ul style="list-style-type: none"> <li>• <b>Error Frame Seconds Summary Errors</b></li> </ul>	This two-octet field indicates the number of errored frame seconds in the period, encoded as a 16-bit unsigned integer.
<ul style="list-style-type: none"> <li>• <b>Total Error Frame Seconds Summary Errors</b></li> </ul>	This four-octet field indicates the sum of errored frame seconds that have been detected since the OAM sublayer was reset.
<ul style="list-style-type: none"> <li>• <b>Total Error Frame Seconds Summary Events</b></li> </ul>	This four-octet field indicates the number of Errored Frame Seconds Summary Event TLVs that have been generated since the OAM sublayer was reset, encoded as a 32bit unsigned integer.

**Buttons**

: Click to refresh the page.

: Click to clear the data.

**4.3.14.4 Port Settings**

This page allows the user to inspect the current Link OAM port configurations, and change them as well, as screen in [Figure 4-3-14-4](#) appears.

Link OAM Port Configuration						
Port	OAM Enabled	OAM Mode	Loopback Support	Link Monitor Support	MIB Retrieval Support	Loopback Operation
*	<input type="checkbox"/>	<All> ▼	<input type="checkbox"/>	<input type="checkbox"/>	<input type="checkbox"/>	<input type="checkbox"/>
1	<input type="checkbox"/>	Passive ▼	<input type="checkbox"/>	<input checked="" type="checkbox"/>	<input type="checkbox"/>	<input type="checkbox"/>
2	<input type="checkbox"/>	Passive ▼	<input type="checkbox"/>	<input checked="" type="checkbox"/>	<input type="checkbox"/>	<input type="checkbox"/>
3	<input type="checkbox"/>	Passive ▼	<input type="checkbox"/>	<input checked="" type="checkbox"/>	<input type="checkbox"/>	<input type="checkbox"/>
4	<input type="checkbox"/>	Passive ▼	<input type="checkbox"/>	<input checked="" type="checkbox"/>	<input type="checkbox"/>	<input type="checkbox"/>
5	<input type="checkbox"/>	Passive ▼	<input type="checkbox"/>	<input checked="" type="checkbox"/>	<input type="checkbox"/>	<input type="checkbox"/>
6	<input type="checkbox"/>	Passive ▼	<input type="checkbox"/>	<input checked="" type="checkbox"/>	<input type="checkbox"/>	<input type="checkbox"/>
7	<input type="checkbox"/>	Passive ▼	<input type="checkbox"/>	<input checked="" type="checkbox"/>	<input type="checkbox"/>	<input type="checkbox"/>
8	<input type="checkbox"/>	Passive ▼	<input type="checkbox"/>	<input checked="" type="checkbox"/>	<input type="checkbox"/>	<input type="checkbox"/>
9	<input type="checkbox"/>	Passive ▼	<input type="checkbox"/>	<input checked="" type="checkbox"/>	<input type="checkbox"/>	<input type="checkbox"/>
10	<input type="checkbox"/>	Passive ▼	<input type="checkbox"/>	<input checked="" type="checkbox"/>	<input type="checkbox"/>	<input type="checkbox"/>
11	<input type="checkbox"/>	Passive ▼	<input type="checkbox"/>	<input checked="" type="checkbox"/>	<input type="checkbox"/>	<input type="checkbox"/>
12	<input type="checkbox"/>	Passive ▼	<input type="checkbox"/>	<input checked="" type="checkbox"/>	<input type="checkbox"/>	<input type="checkbox"/>
13	<input type="checkbox"/>	Passive ▼	<input type="checkbox"/>	<input checked="" type="checkbox"/>	<input type="checkbox"/>	<input type="checkbox"/>
14	<input type="checkbox"/>	Passive ▼	<input type="checkbox"/>	<input checked="" type="checkbox"/>	<input type="checkbox"/>	<input type="checkbox"/>
15	<input type="checkbox"/>	Passive ▼	<input type="checkbox"/>	<input checked="" type="checkbox"/>	<input type="checkbox"/>	<input type="checkbox"/>
16	<input type="checkbox"/>	Passive ▼	<input type="checkbox"/>	<input checked="" type="checkbox"/>	<input type="checkbox"/>	<input type="checkbox"/>
17	<input type="checkbox"/>	Passive ▼	<input type="checkbox"/>	<input checked="" type="checkbox"/>	<input type="checkbox"/>	<input type="checkbox"/>
18	<input type="checkbox"/>	Passive ▼	<input type="checkbox"/>	<input checked="" type="checkbox"/>	<input type="checkbox"/>	<input type="checkbox"/>

Figure 4-3-14-4: Port Status Page Screenshot

The page includes the following fields:

### General Settings

Object	Description
• <b>Port</b>	The switch port number.
• <b>OAM Enabled</b>	Controls whether Link OAM is enabled on this switch port. Enabling Link OAM provides the network operators the ability to monitor the health of the network and quickly determine the location of failing links or fault conditions.
• <b>OAM Mode</b>	<p>Configures the OAM Mode as Active or Passive. The default mode is Passive.</p> <ul style="list-style-type: none"> <li>■ <b>Active mode</b> DTE's configured in Active mode initiate the exchange of Information OAMPDUs as defined by the Discovery process. Once the Discovery process completes, Active DTE's are permitted to send any OAMPDU while connected to a remote OAM peer entity in Active mode. Active DTE's operate in a limited respect if the remote OAM entity is operating in Passive mode. Active devices should not respond to OAM remote loopback commands and variable requests from a Passive peer.</li> <li>■ <b>Passive mode</b> DTE's configured in Passive mode do not initiate the Discovery process. Passive DTE's react to the initiation of the Discovery process by the remote DTE. This eliminates the possibility of passive to passive links. Passive DTE's shall not send Variable Request or Loopback Control OAMPDUs.</li> </ul>
• <b>Loopback Support</b>	Controls whether the loopback support is enabled for the switch port. Link OAM remote loopback can be used for fault localization and link performance testing. Enabling the loopback support will allow the DTE to execute the remote loopback command that helps in the fault detection.
• <b>Link Monitor Support</b>	Controls whether the Link Monitor support is enabled for the switch port. On enabling the Link Monitor support, the DTE supports event notification that permits the inclusion of diagnostic information.
• <b>MIB Retrieval Support</b>	Controls whether the MIB Retrieval Support is enabled for the switch port. On enabling the MIB retrieval support, the DTE supports polling of various Link OAM based MIB variables' contents.
• <b>Loopback Operation</b>	If the Loopback support is enabled, enabling this field will start a loopback operation for the port.

### Buttons

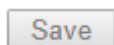
 : Click to save changes.

 : Click to undo any changes made locally and revert to previously saved values.

### 4.3.14.5 Event Settings

This page allows the user to inspect the current Link OAM Link Event configurations, and change them as well, as screen in [Figure 4-3-14-5](#) appears.

## Link Event Configuration for Port 1

Port 1 ▼

Event Name	Error Window	Error Threshold
Error Frame Event	1	1
Symbol Period Error Event	1	1
Seconds Summary Event	60	1

Save
Reset

**Figure 4-3-14-5:** Event Settings Page Screenshot

The page includes the following fields:

#### General Settings

Object	Description
• <b>Port</b>	The switch port number.
• <b>Event Name</b>	Name of the Link Event which is being configured.
• <b>Error Window</b>	Represents the window period in the order of 1 sec for the observation of various link events.
• <b>Error Threshold</b>	Represents the threshold value for the window period for the appropriate Link event so as to notify the peer of this error.
• <b>Error Frame Event</b>	The Errored Frame Event counts the number of errored frames detected during the specified period. The period is specified by a time interval ( Window in order of 1 sec). This event is generated if the errored frame count is equal to or greater than the specified threshold for that period (Period Threshold). Errored frames are frames that had transmission errors as detected at the Media Access Control sublayer. Error Window for 'Error Frame Event' must be an integer value between 1-60 and its default value is '1'. Whereas Error Threshold must be between 0-4294967295 and its default value is '1'.
• <b>Symbol Period Error Event</b>	ved in a time interval on the underlying physical layer. This event is generated if the symbol error count is equal to or greater than the specified threshold for that period. Error Window for 'Symbol Period Error Event' must be an integer value between 1-60 and its default value is '1'. Whereas Error Threshold must be between 0-4294967295 and its default value is '1'.

---

<ul style="list-style-type: none"><li>• <b>Seconds Summary Event</b></li></ul>	<p>The Errored Frame Seconds Summary Event TLV counts the number of errored frame seconds that occurred during the specified period. The period is specified by a time interval. This event is generated if the number of errored frame seconds is equal to or greater than the specified threshold for that period. An errored frame second is a one second interval wherein at least one frame error was detected. Errored frames are frames that had transmission errors as detected at the Media Access Control sublayer. Error Window for 'Seconds Summary Event' must be an integer value between 10-900 and its default value is '60'. Whereas Error Threshold must be between 0-65535 and its default value is '1'.</p>
--	---

---

**Buttons**

: Click to save changes.

: Click to undo any changes made locally and revert to previously saved values.

**4.3.14.6 MIB Retrieval**

This page allows you to configure Link OAM MIB Retrieval, as screen in [Figure 4-3-14-6](#) appears.

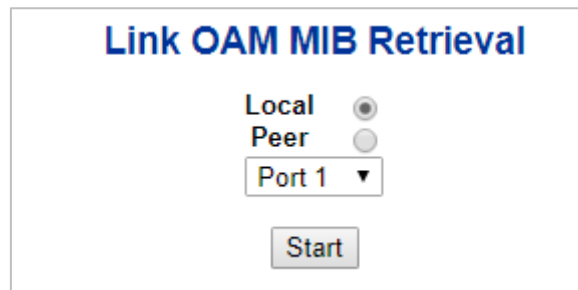

**Figure 4-3-14-6:** MIB Retrieval Page Screenshot

### 4.3.14.7 Link-OAM Example

CE and PE devices with point-to-point link enable EFM OAM to monitor “the First Mile” link performance. It will report the log information to network management system when occurring fault event and use remote loopback function to detect the link in necessary instance

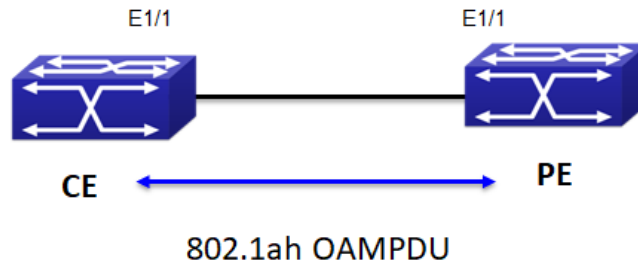

Figure 4-3-14-7: Typical OAM application topology

The configuration of link-oam is quite simple.

#### Step 1. Set CE as Passive OAM mode

#### Link OAM Port Configuration

Port	OAM Enabled	OAM Mode	Loopback Support	Link Monitor Support	MIB Retrieval Support	Loopback Operation
*	<input type="checkbox"/>	<All>	<input type="checkbox"/>	<input type="checkbox"/>	<input type="checkbox"/>	<input type="checkbox"/>
1	<input checked="" type="checkbox"/>	Passive	<input type="checkbox"/>	<input checked="" type="checkbox"/>	<input type="checkbox"/>	<input type="checkbox"/>

#### Step 2. Set PE as Active OAM mode

#### Link OAM Port Configuration

Port	OAM Enabled	OAM Mode	Loopback Support	Link Monitor Support	MIB Retrieval Support	Loopback Operation
*	<input type="checkbox"/>	<All>	<input type="checkbox"/>	<input type="checkbox"/>	<input type="checkbox"/>	<input type="checkbox"/>
1	<input checked="" type="checkbox"/>	Active	<input type="checkbox"/>	<input checked="" type="checkbox"/>	<input type="checkbox"/>	<input type="checkbox"/>

#### Step 3. Check OAM status and statistic from CE device

#### Detailed Link OAM Status for Port 1

Port 1 Auto-refresh  Refresh

PDU Permission	Any
Discovery State	SEND_ANY_STATE
Peer MAC Address	00:30:4f:11:22:55

Local		Peer	
Mode	Passive	Mode	Active
Unidirectional Operation Support	Disabled	Unidirectional Operation Support	Disabled
Remote Loopback Support	Disabled	Remote Loopback Support	Disabled
Link Monitoring Support	Enabled	Link Monitoring Support	Enabled
MIB Retrieval Support	Disabled	MIB Retrieval Support	Disabled
MTU Size	1500	MTU Size	1500
Multiplexer State	Forwarding	Multiplexer State	Forwarding
Parser State	Forwarding	Parser State	Forwarding
Organizational Unique Identification	00-30-4f	Organizational Unique Identification	00-30-4f
PDU Revision	1	PDU Revision	0

#### Detailed Link OAM Statistics for Port 1

Port 1 Auto-refresh  Refresh Clear

Receive Total		Transmit Total	
Rx OAM Information PDU's	232	Tx OAM Information PDU's	232

## 4.4 Quality of Service

### 4.4.1 General

Quality of Service (QoS) is an advanced traffic prioritization feature that allows you to establish control over network traffic. QoS enables you to assign various grades of network service to different types of traffic, such as multi-media, video, protocol-specific, time critical, and file-backup traffic.

QoS reduces bandwidth limitations, delay, loss, and jitter. It also provides increased reliability for delivery of your data and allows you to prioritize certain applications across your network. You can define exactly how you want the switch to treat selected applications and types of traffic. You can use QoS on your system to:

- Control a wide variety of network traffic by:
- Classifying traffic based on packet attributes.
- Assigning priorities to traffic (for example, to set higher priorities to time-critical or business-critical applications).
- Applying security policy through traffic filtering.
- Provide predictable throughput for multimedia applications such as video conferencing or voice over IP by minimizing delay and jitter.
- Improve performance for specific types of traffic and preserve performance as the amount of traffic grows.
- Reduce the need to constantly add bandwidth to the network.
- Manage network congestion.

### QoS Terminology

- **Classifier**—classifies the traffic on the network. Traffic classifications are determined by protocol, application, source, destination, and so on. You can create and modify classifications. The Switch then groups classified traffic in order to schedule them with the appropriate service level.
- **DiffServ Code Point (DSCP)** — is the traffic prioritization bits within an IP header that are encoded by certain applications and/or devices to indicate the level of service required by the packet across a network.
- **Service Level**—defines the priority that will be given to a set of classified traffic. You can create and modify service levels.
- **Policy**—comprises a set of “rules” that are applied to a network so that a network meets the needs of the business. That is, traffic can be prioritized across a network according to its importance to that particular business type.
- **QoS Profile**—consists of multiple sets of rules (classifier plus service level combinations). The QoS profile is assigned to a port(s).
- **Rules**—comprises a service level and a classifier to define how the Switch will treat certain types of traffic. Rules are associated with a QoS Profile (see above).

To implement QoS on your network, you need to carry out the following actions:

1. Define a service level to determine the priority that will be applied to traffic.
2. Apply a classifier to determine how the incoming traffic will be classified and thus treated by the Switch.
3. Create a QoS profile which associates a service level and a classifier.
4. Apply a QoS profile to a port(s).

### 4.4.1.1 QoS Port Classification

This page allows you to configure the basic QoS Classification settings for all switch ports. The Port classification screen in Figure 4-4-1-1 appears.

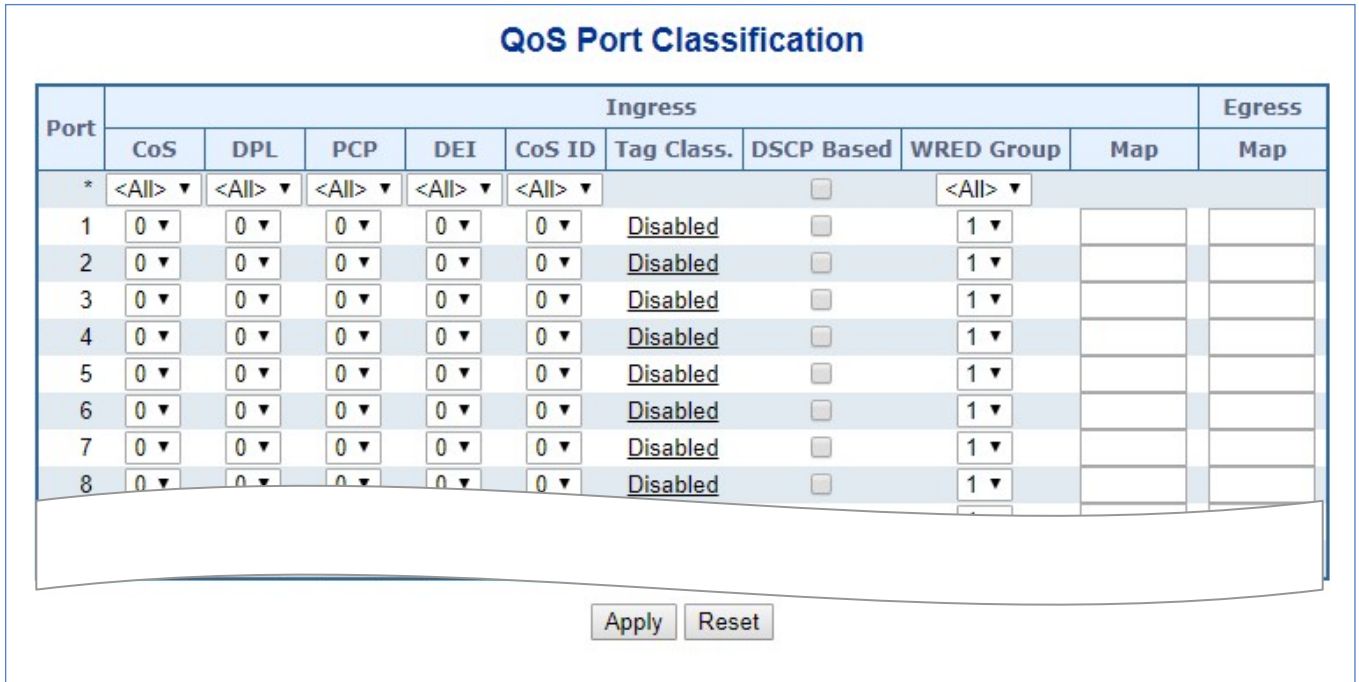

Port	Ingress								Egress	
	CoS	DPL	PCP	DEI	CoS ID	Tag Class.	DSCP Based	WRED Group	Map	Map
*	<All>	<All>	<All>	<All>	<All>		<input type="checkbox"/>	<All>		
1	0	0	0	0	0	Disabled	<input type="checkbox"/>	1		
2	0	0	0	0	0	Disabled	<input type="checkbox"/>	1		
3	0	0	0	0	0	Disabled	<input type="checkbox"/>	1		
4	0	0	0	0	0	Disabled	<input type="checkbox"/>	1		
5	0	0	0	0	0	Disabled	<input type="checkbox"/>	1		
6	0	0	0	0	0	Disabled	<input type="checkbox"/>	1		
7	0	0	0	0	0	Disabled	<input type="checkbox"/>	1		
8	0	0	0	0	0	Disabled	<input type="checkbox"/>	1		

Figure 4-4-1-1: QoS Ingress Port Policers Page Screenshot

The page includes the following fields:

Object	Description
<ul style="list-style-type: none"> <li>• <b>Port</b></li> </ul>	The port number for which the configuration below applies.
<ul style="list-style-type: none"> <li>• <b>CoS</b></li> </ul>	<p>Controls the default <a href="#">CoS</a> value.</p> <p>All frames are classified to a CoS. There is a one to one mapping between CoS, queue and priority. A CoS of 0 (zero) has the lowest priority. If the port is VLAN aware, the frame is tagged and Tag Class. is enabled, then the frame is classified to a CoS that is mapped from the PCP and DEI value in the tag. Otherwise the frame is classified to the default CoS.</p> <p>The classified CoS can be overruled by a QCL entry.</p> <p><b>Note:</b> If the default CoS has been dynamically changed, then the actual default CoS is shown in parentheses after the configured default CoS.</p>
<ul style="list-style-type: none"> <li>• <b>DPL</b></li> </ul>	<p>Controls the default <a href="#">DPL</a> value.</p> <p>All frames are classified to a Drop Precedence Level.</p> <p>If the port is VLAN aware, the frame is tagged and Tag Class. is enabled, then the frame is classified to a DPL that is mapped from the PCP and DEI value in the tag. Otherwise the frame is classified to the default DPL.</p> <p style="text-align: center;">The classified DPL can be overruled by a QCL entry.</p>



<ul style="list-style-type: none"> <li>• <b>PCP</b></li> </ul>	<p>Controls the default <a href="#">PCP</a> value.</p> <p>All frames are classified to a PCP value.</p> <p>If the port is VLAN aware and the frame is tagged, then the frame is classified to the PCP value in the tag. Otherwise the frame is classified to the default PCP value.</p>
<ul style="list-style-type: none"> <li>• <b>DEI</b></li> </ul>	<p>Controls the default <a href="#">DEI</a> value.</p> <p>All frames are classified to a DEI value.</p> <p>If the port is VLAN aware and the frame is tagged, then the frame is classified to the DEI value in the tag. Otherwise the frame is classified to the default DEI value.</p>
<ul style="list-style-type: none"> <li>• <b>CoS ID</b></li> </ul>	<p>Controls the default <a href="#">CoS ID</a> value.</p> <p>Every incoming frame is classified to a CoS ID, which later can be used as basis for rewriting of different parts of the frame.</p>
<ul style="list-style-type: none"> <li>• <b>Tag Class.</b></li> </ul>	<p>Shows the classification mode for tagged frames on this port.</p> <p><b>Disabled:</b> Use default <a href="#">CoS</a> and <a href="#">DPL</a> for tagged frames.</p> <p><b>Enabled:</b> Use mapped versions of <a href="#">PCP</a> and <a href="#">DEI</a> for tagged frames.</p> <p>Click on the mode in order to configure the mode and/or mapping.</p> <p><b>Note:</b> This setting has no effect if the port is VLAN unaware. Tagged frames received on VLAN unaware ports are always classified to the default CoS and DPL.</p>
<ul style="list-style-type: none"> <li>• <b>DSCP Based</b></li> </ul>	<p>Click to Enable <a href="#">DSCP</a> Based QoS Ingress Port Classification.</p>
<ul style="list-style-type: none"> <li>• <b>WRED Group</b></li> </ul>	<p>Controls the <a href="#">WRED</a> group membership.</p>
<ul style="list-style-type: none"> <li>• <b>Ingress Map</b></li> </ul>	<p>Controls the <a href="#">Ingress Map</a> selection through the Map ID. The Ingress Map ID ranges from <b>0</b> to <b>255</b>. An empty field indicates no map selection.</p>
<ul style="list-style-type: none"> <li>• <b>Egress Map</b></li> </ul>	<p>Controls the <a href="#">Egress Map</a> selection through the Map ID. The Egress Map ID ranges from <b>0</b> to <b>511</b>. An empty field indicates no map selection</p>

**Buttons**

 : Click to apply changes

 : Click to undo any changes made locally and revert to previously saved values.

**4.4.1.2 Queue Policing**

This page allows you to configure the Queue Policer settings for all switch ports.. The Queue Policing screen in [Figure 4-4-1-2](#) appears.

### QoS Ingress Queue Policers

Port	Queue 0	Queue 1	Queue 2	Queue 3	Queue 4	Queue 5	Queue 6	Queue 7
	Enable	Enable	Enable	Enable	Enable	Enable	Enable	Enable
*	<input type="checkbox"/>	<input type="checkbox"/>	<input type="checkbox"/>	<input type="checkbox"/>	<input type="checkbox"/>	<input type="checkbox"/>	<input type="checkbox"/>	<input type="checkbox"/>
1	<input type="checkbox"/>	<input type="checkbox"/>	<input type="checkbox"/>	<input type="checkbox"/>	<input type="checkbox"/>	<input type="checkbox"/>	<input type="checkbox"/>	<input type="checkbox"/>
2	<input type="checkbox"/>	<input type="checkbox"/>	<input type="checkbox"/>	<input type="checkbox"/>	<input type="checkbox"/>	<input type="checkbox"/>	<input type="checkbox"/>	<input type="checkbox"/>
3	<input type="checkbox"/>	<input type="checkbox"/>	<input type="checkbox"/>	<input type="checkbox"/>	<input type="checkbox"/>	<input type="checkbox"/>	<input type="checkbox"/>	<input type="checkbox"/>
4	<input type="checkbox"/>	<input type="checkbox"/>	<input type="checkbox"/>	<input type="checkbox"/>	<input type="checkbox"/>	<input type="checkbox"/>	<input type="checkbox"/>	<input type="checkbox"/>
5	<input type="checkbox"/>	<input type="checkbox"/>	<input type="checkbox"/>	<input type="checkbox"/>	<input type="checkbox"/>	<input type="checkbox"/>	<input type="checkbox"/>	<input type="checkbox"/>
6	<input type="checkbox"/>	<input type="checkbox"/>	<input type="checkbox"/>	<input type="checkbox"/>	<input type="checkbox"/>	<input type="checkbox"/>	<input type="checkbox"/>	<input type="checkbox"/>
7	<input type="checkbox"/>	<input type="checkbox"/>	<input type="checkbox"/>	<input type="checkbox"/>	<input type="checkbox"/>	<input type="checkbox"/>	<input type="checkbox"/>	<input type="checkbox"/>
8	<input type="checkbox"/>	<input type="checkbox"/>	<input type="checkbox"/>	<input type="checkbox"/>	<input type="checkbox"/>	<input type="checkbox"/>	<input type="checkbox"/>	<input type="checkbox"/>

Figure 4-4-1-2 : QoS Ingress Port Classification Page Screenshot

The page includes the following fields:

Object	Description
<ul style="list-style-type: none"> <li>• <b>Port</b></li> </ul>	The port number for which the configuration below applies.
<ul style="list-style-type: none"> <li>• <b>Enable (E)</b></li> </ul>	Enable or disable the queue policer for this switch port.
<ul style="list-style-type: none"> <li>• <b>Rate</b></li> </ul>	Controls the rate for the queue policer. This value is restricted to 25-13128147 when "Unit" is kbps, and 1-13128 when "Unit" is Mbps. The rate is internally rounded up to the nearest value supported by the queue policer. This field is only shown if at least one of the queue policers are enabled.
<ul style="list-style-type: none"> <li>• <b>Unit</b></li> </ul>	Controls the unit of measure for the queue policer rate as kbps or Mbps. This field is only shown if at least one of the queue policers are enabled.

**Buttons**



: Click to apply changes



: Click to undo any changes made locally and revert to previously saved values.

**4.4.1.3 Port Tag Remarking**

This page provides an overview of QoS Egress Port Tag Remarking for all switch ports. The Port tag remarking screen in [Figure 4-4-1-3](#) appears.

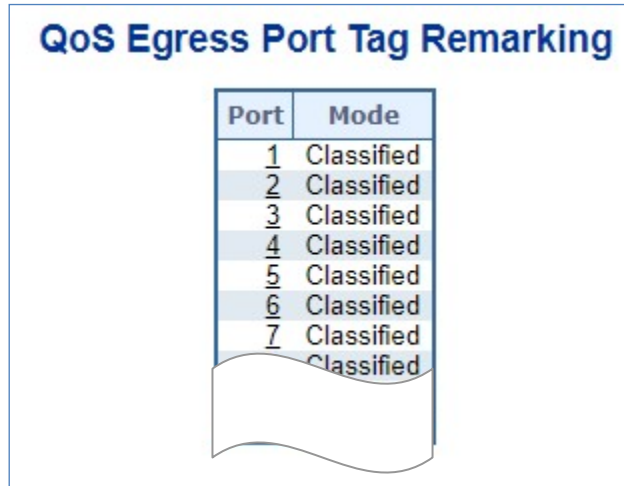

Figure 4-4-1-3: Port Tag Remarking Page Screenshot

The page includes the following fields:

Object	Description
<ul style="list-style-type: none"> <li>• Port</li> </ul>	<p>he logical port for the settings contained in the same row.</p> <p>Click on the port number in order to configure tag remarking</p>
<ul style="list-style-type: none"> <li>• Mode</li> </ul>	<p>Shows the tag remarking mode for this port.</p> <p><b>Classified:</b> Use classified <a href="#">PCP/DEI</a> values.</p> <p><b>Default:</b> Use default PCP/DEI values.</p> <p><b>Mapped:</b> Use mapped versions of <a href="#">CoS</a> and <a href="#">DPL</a>.</p>

#### 4.4.1.4 WRED

This page allows you to configure the Random Early Detection (RED) settings.. The Port Shaper screen in [Figure 4-4-4](#) appears.

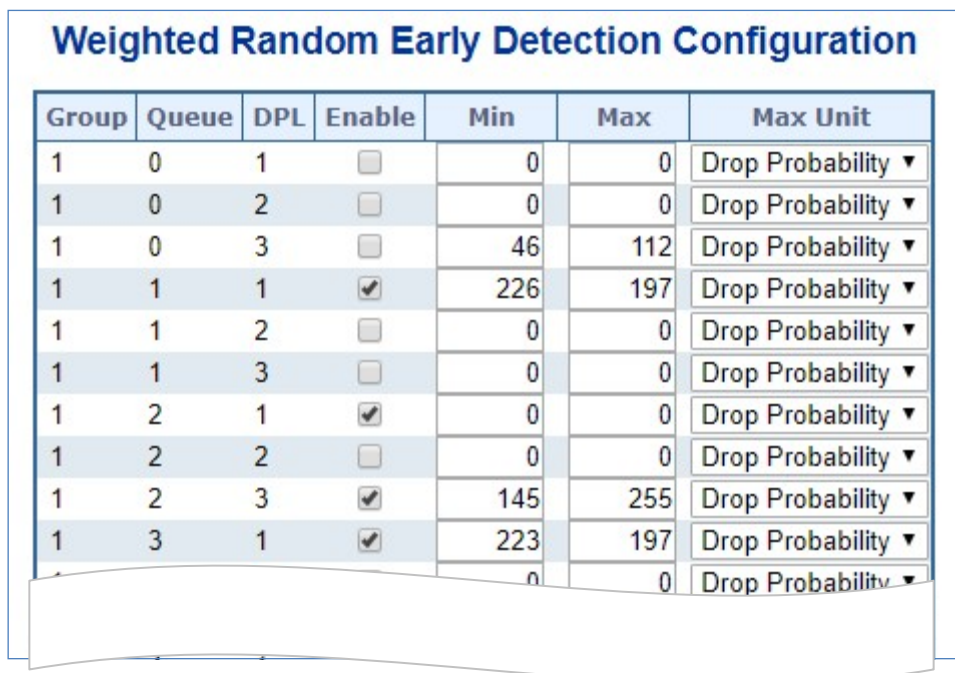

Figure 4-4-1-4: QoS Egress Port Shapers Page Screenshot

The page includes the following fields:

Object	Description
• <b>Group</b>	The WRED group number for which the configuration below applies.
• <b>Queue</b>	The queue number (CoS) for which the configuration below applies.
• <b>DPL</b>	The Drop Precedence Level for which the configuration below applies.
• <b>Enable</b>	Controls whether RED is enabled for this entry.
• <b>Min</b>	Controls the lower RED fill level threshold. If the queue filling level is below this threshold, the drop probability is zero. This value is restricted to 0-100%.
• <b>Max</b>	Controls the upper RED drop probability or fill level threshold for frames marked with <a href="#">Drop Precedence Level</a> > 0 (yellow frames). This value is restricted to 1-100%.
• <b>Max Unit</b>	Selects the unit for Max. Possible values are:  <b>Drop Probability</b> : Max controls the drop probability just below 100% fill level.  <b>Fill Level</b> : Max controls the fill level where drop probability reaches 100%..

**Buttons**

**Apply** : Click to apply changes

**Reset** : Click to undo any changes made locally and revert to previously saved values.

**4.4.1.5 Statistics**

This page provides statistics for the different queues for all switch ports. The statistic screen in [Figure 4-4-1-5](#) appears.

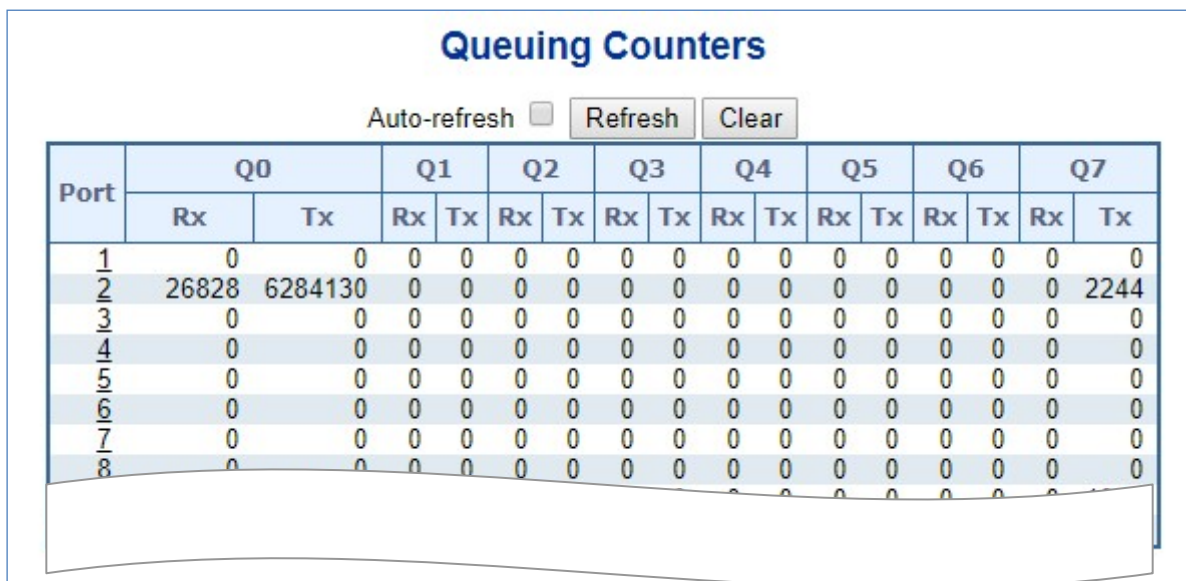

Port	Q0		Q1		Q2		Q3		Q4		Q5		Q6		Q7		
	Rx	Tx	Rx	Tx	Rx	Tx	Rx	Tx	Rx	Tx	Rx	Tx	Rx	Tx	Rx	Tx	
1	0	0	0	0	0	0	0	0	0	0	0	0	0	0	0	0	0
2	26828	6284130	0	0	0	0	0	0	0	0	0	0	0	0	0	0	2244
3	0	0	0	0	0	0	0	0	0	0	0	0	0	0	0	0	0
4	0	0	0	0	0	0	0	0	0	0	0	0	0	0	0	0	0
5	0	0	0	0	0	0	0	0	0	0	0	0	0	0	0	0	0
6	0	0	0	0	0	0	0	0	0	0	0	0	0	0	0	0	0
7	0	0	0	0	0	0	0	0	0	0	0	0	0	0	0	0	0
8	0	0	0	0	0	0	0	0	0	0	0	0	0	0	0	0	0

Figure 4-4-1-5: QoS statistics Page Screenshot

The page includes the following fields:

Object	Description
• Port	The logical port for the settings contained in the same row.
• Qn	There are 8 QoS queues per port. Q0 is the lowest priority queue.
• Rx/Tx	The number of received and transmitted packets per queue.

**Buttons**

**Refresh** : Click to refresh the page immediately.

**Clear** : Clears the counters for all ports

## 4.4.2 Bandwidth Control

### 4.4.2.1 Port Policing

This page allows you to configure the Policer settings for all switch ports. The Port Policing screen in [Figure 4-4-2-1](#) appears.

Port	Enabled	Rate	Unit	Flow Control
*	<input type="checkbox"/>	500	<All>	<input type="checkbox"/>
1	<input type="checkbox"/>	500	kbps	<input type="checkbox"/>
2	<input type="checkbox"/>	500	kbps	<input type="checkbox"/>
3	<input type="checkbox"/>	500	kbps	<input type="checkbox"/>
4	<input type="checkbox"/>	500	kbps	<input type="checkbox"/>
5	<input type="checkbox"/>	500	kbps	<input type="checkbox"/>
6	<input type="checkbox"/>	500	kbps	<input type="checkbox"/>
7	<input type="checkbox"/>	500	kbps	<input type="checkbox"/>

Figure 4-4-2-1: QoS Ingress Port Policers Page Screenshot

The page includes the following fields:

Object	Description
• <b>Port</b>	The port number for which the configuration below applies.
• <b>Enable</b>	Controls whether the policer is enabled on this switch port.
• <b>Rate</b>	Controls the rate for the policer. This value is restricted to 100-1000000 when the "Unit" is " <b>kbps</b> " or " <b>fps</b> ", and it is restricted to 1-3300 when the "Unit" is " <b>Mbps</b> " or " <b>kfps</b> ". The default value is <b>500</b> .
• <b>Unit</b>	Controls the unit of measure for the policer rate as <b>kbps</b> , <b>Mbps</b> , <b>fps</b> or <b>kfps</b> . The default value is " <b>kbps</b> ".
• <b>Flow Control</b>	If flow control is enabled and the port is in flow control mode, then pause frames are sent instead of discarding frames.

#### Buttons

 : Click to apply changes

 : Click to undo any changes made locally and revert to previously saved values.

### 4.4.2.2 Port Schedule

The Port Scheduler and Shapers for a specific port are configured on this page. The QoS Egress Port Schedule and Shaper screen in [Figure 4-4-2-2](#) appears.

Port	Mode	Weight							
		Q0	Q1	Q2	Q3	Q4	Q5	Q6	Q7
1	Strict Priority	-	-	-	-	-	-	-	-
2	Strict Priority	-	-	-	-	-	-	-	-
3	Strict Priority	-	-	-	-	-	-	-	-
4	Strict Priority	-	-	-	-	-	-	-	-
5	Strict Priority	-	-	-	-	-	-	-	-
6	Strict Priority	-	-	-	-	-	-	-	-
7	Strict Priority	-	-	-	-	-	-	-	-
8	Strict Priority	-	-	-	-	-	-	-	-

Port 1

### QoS Egress Port Scheduler and Shapers Port 1

Scheduler Mode: Strict Priority

Queue Shaper				Port Shaper		
Enable	Rate	Unit	Excess	Enable	Rate	Unit
<input type="checkbox"/>	500	kbps	<input type="checkbox"/>	<input type="checkbox"/>	500	kbps
<input type="checkbox"/>	500	kbps	<input type="checkbox"/>	<input type="checkbox"/>	500	kbps
<input type="checkbox"/>	500	kbps	<input type="checkbox"/>	<input type="checkbox"/>	500	kbps
<input type="checkbox"/>	500	kbps	<input type="checkbox"/>	<input type="checkbox"/>	500	kbps
<input type="checkbox"/>	500	kbps	<input type="checkbox"/>	<input type="checkbox"/>	500	kbps
<input type="checkbox"/>	500	kbps	<input type="checkbox"/>	<input type="checkbox"/>	500	kbps
<input type="checkbox"/>	500	kbps	<input type="checkbox"/>	<input type="checkbox"/>	500	kbps
<input type="checkbox"/>	500	kbps	<input type="checkbox"/>	<input type="checkbox"/>	500	kbps

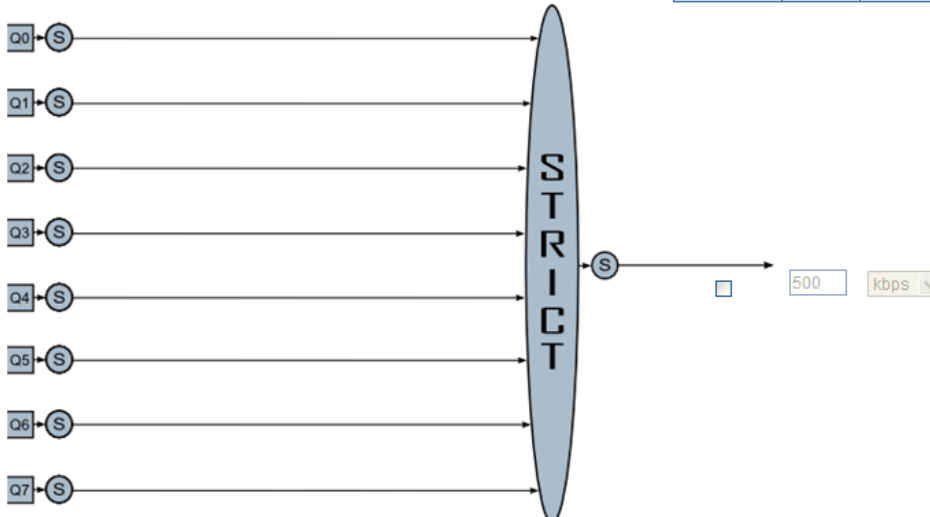

Figure 4-4-2-2: QoS Egress Port Schedule and Shapers Page Screenshot

The page includes the following fields:

Object	Description
--------	-------------

• <b>Schedule Mode</b>	Controls whether the scheduler mode is " <b>Strict Priority</b> " or " <b>Weighted</b> " on this switch port.
• <b>Queue Shaper Enable</b>	Controls whether the queue shaper is enabled for this queue on this switch port.
• <b>Queue Shaper Rate</b>	Controls the rate for the queue shaper. This value is restricted to 100-1000000 when the "Unit" is "kbps", and it is restricted to 1-13200 when the "Unit" is "Mbps". The default value is <b>500</b> .
• <b>Queue Shaper Unit</b>	Controls the unit of measure for the queue shaper rate as " <b>kbps</b> " or " <b>Mbps</b> ". The default value is "kbps".
• <b>Queue Shaper Excess</b>	Controls whether the queue is allowed to use excess bandwidth.
• <b>Queue Scheduler Weight</b>	Controls the weight for this queue. This value is restricted to 1-100. This parameter is only shown if "Scheduler Mode" is set to " <b>Weighted</b> ". The default value is " <b>17</b> ".
• <b>Queue Scheduler Percent</b>	Shows the weight in percent for this queue. This parameter is only shown if "Scheduler Mode" is set to "Weighted".
• <b>Port Shaper Enable</b>	Controls whether the port shaper is enabled for this switch port.
• <b>Port Shaper Rate</b>	Controls the rate for the port shaper. This value is restricted to 100-1000000 when the "Unit" is "kbps", and it is restricted to 1-13200 when the "Unit" is "Mbps". The default value is 500.
• <b>Port Shaper Unit</b>	Controls the unit of measure for the port shaper rate as "kbps" or "Mbps". The default value is "kbps".

**Buttons**

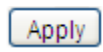
 : Click to apply changes

 : Click to undo any changes made locally and revert to previously saved values.

 : Click to undo any changes made locally and return to the previous page.

**4.4.2.3 Port Shaping**

This page provides an overview of QoS Egress Port Shapers for all switch ports. The Port shaping screen in [Figure 4-4-2-3](#) appears.



### QoS Egress Port Shapers

Port	Shapers								Port
	Q0	Q1	Q2	Q3	Q4	Q5	Q6	Q7	
1	-	-	-	-	-	-	-	-	-
2	-	-	-	-	-	-	-	-	-
3	-	-	-	-	-	-	-	-	-
4	-	-	-	-	-	-	-	-	-
5	-	-	-	-	-	-	-	-	-
6	-	-	-	-	-	-	-	-	-
7	-	-	-	-	-	-	-	-	-
8	-	-	-	-	-	-	-	-	-

Port 1

### QoS Egress Port Scheduler and Shapers Port 1

Scheduler Mode: Strict Priority

Queue Shaper			
Enable	Rate	Unit	Excess
<input type="checkbox"/>	500	kbps	<input type="checkbox"/>
<input type="checkbox"/>	500	kbps	<input type="checkbox"/>
<input type="checkbox"/>	500	kbps	<input type="checkbox"/>
<input type="checkbox"/>	500	kbps	<input type="checkbox"/>
<input type="checkbox"/>	500	kbps	<input type="checkbox"/>
<input type="checkbox"/>	500	kbps	<input type="checkbox"/>
<input type="checkbox"/>	500	kbps	<input type="checkbox"/>
<input type="checkbox"/>	500	kbps	<input type="checkbox"/>
<input type="checkbox"/>	500	kbps	<input type="checkbox"/>

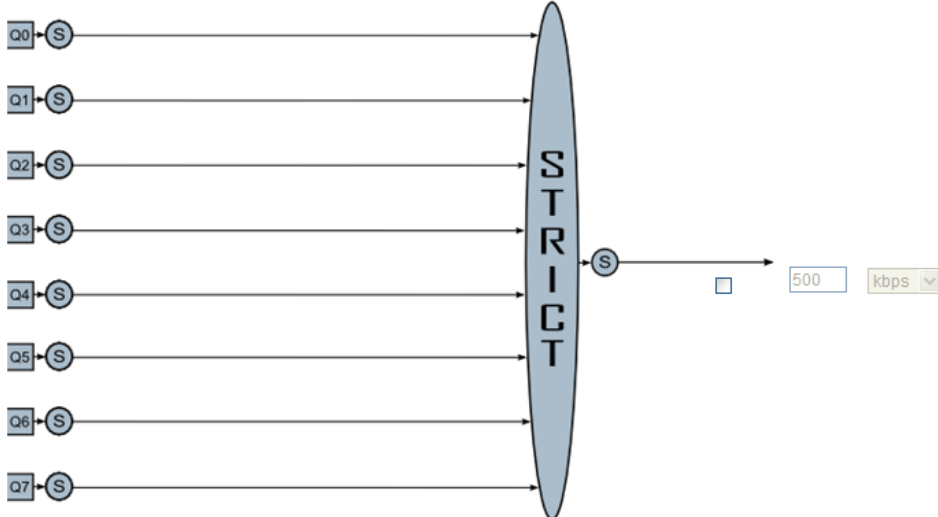

Port Shaper		
Enable	Rate	Unit
<input type="checkbox"/>	500	kbps

Apply Reset Cancel

Figure 4-4-2-3: QoS Egress Port Schedule and Shapers Page Screenshot

The page includes the following fields:

Object	Description
<ul style="list-style-type: none"> <li><b>Schedule Mode</b></li> </ul>	Controls whether the scheduler mode is <b>"Strict Priority"</b> or <b>"Weighted"</b> on this switch port.
<ul style="list-style-type: none"> <li><b>Queue Shaper Enable</b></li> </ul>	Controls whether the queue shaper is enabled for this queue on this switch port.
<ul style="list-style-type: none"> <li><b>Queue Shaper Rate</b></li> </ul>	Controls the rate for the queue shaper. This value is restricted to 100-1000000 when the "Unit" is "kbps", and it is

	restricted to 1-13200 when the "Unit" is "Mbps". The default value is <b>500</b> .
• <b>Queue Shaper Unit</b>	Controls the unit of measure for the queue shaper rate as " <b>kbps</b> " or " <b>Mbps</b> ". The default value is "kbps".
• <b>Queue Shaper Excess</b>	Controls whether the queue is allowed to use excess bandwidth.
• <b>Queue Scheduler Weight</b>	Controls the weight for this queue. This value is restricted to 1-100. This parameter is only shown if "Scheduler Mode" is set to " <b>Weighted</b> ". The default value is " <b>17</b> ".
• <b>Queue Scheduler Percent</b>	Shows the weight in percent for this queue. This parameter is only shown if "Scheduler Mode" is set to "Weighted".
• <b>Port Shaper Enable</b>	Controls whether the port shaper is enabled for this switch port.
• <b>Port Shaper Rate</b>	Controls the rate for the port shaper. This value is restricted to 100-1000000 when the "Unit" is "kbps", and it is restricted to 1-13200 when the "Unit" is "Mbps". The default value is 500.
• <b>Port Shaper Unit</b>	Controls the unit of measure for the port shaper rate as "kbps" or "Mbps". The default value is "kbps".

**Buttons**

 : Click to apply changes

 : Click to undo any changes made locally and revert to previously saved values.

 : Click to undo any changes made locally and return to the previous page.

### 4.4.3 Storm Control

#### 4.4.3.1 Storm Policing Configuration

Storm control for the switch is configured on this page. There is a unicast storm rate control, multicast storm rate control, and a broadcast storm rate control. These only affect flooded frames, i.e. frames with a (VLAN ID, DMAC) pair not present on the MAC Address table.

The configuration indicates the permitted packet rate for unicast, multicast or broadcast traffic across the switch.

The Storm Control Configuration screen in [Figure 4-4-3-1](#) appears.

QoS Port Storm Control									
Port	Unicast Frames			Broadcast Frames			Unknown Frames		
	Enabled	Rate	Unit	Enabled	Rate	Unit	Enabled	Rate	Unit
*	<input type="checkbox"/>	500	<All> ▾	<input type="checkbox"/>	500	<All> ▾	<input type="checkbox"/>	500	<All> ▾
1	<input type="checkbox"/>	500	kbits ▾	<input type="checkbox"/>	500	kbits ▾	<input type="checkbox"/>	500	kbits ▾
2	<input type="checkbox"/>	500	kbits ▾	<input type="checkbox"/>	500	kbits ▾	<input type="checkbox"/>	500	kbits ▾
3	<input type="checkbox"/>	500	kbits ▾	<input type="checkbox"/>	500	kbits ▾	<input type="checkbox"/>	500	kbits ▾
4	<input type="checkbox"/>	500	kbits ▾	<input type="checkbox"/>	500	kbits ▾	<input type="checkbox"/>	500	kbits ▾
5	<input type="checkbox"/>	500	kbits ▾	<input type="checkbox"/>	500	kbits ▾	<input type="checkbox"/>	500	kbits ▾
6	<input type="checkbox"/>	500	kbits ▾	<input type="checkbox"/>	500	kbits ▾	<input type="checkbox"/>	500	kbits ▾
7	<input type="checkbox"/>	500	kbits ▾	<input type="checkbox"/>	500	kbits ▾	<input type="checkbox"/>	500	kbits ▾

Figure 4-4-3-1: Storm Control Configuration Page Screenshot

The page includes the following fields:

Object	Description
• <b>Port</b>	The port number for which the configuration below applies.
• <b>Enable</b>	Controls whether the storm control is enabled on this switch port.
• <b>Rate</b>	Controls the rate for the storm control. The default value is 500. This value is restricted to 100-1000000 when the "Unit" is "kbits" or "fps", and it is restricted to 1-13200 when the "Unit" is "Mbps" or "kfps".
• <b>Unit</b>	Controls the unit of measure for the storm control rate as kbits, Mbps, fps or kfps . The default value is "kbits".

#### Buttons

: Click to apply changes

: Click to undo any changes made locally and revert to previously saved values.

## 4.4.4 Differentiated Service

### 4.4.4.1 Port DSCP

This page allows you to configure the basic QoS Port DSCP Configuration settings for all switch ports. The Port DSCP screen in [Figure 4-4-4-1](#) appears.

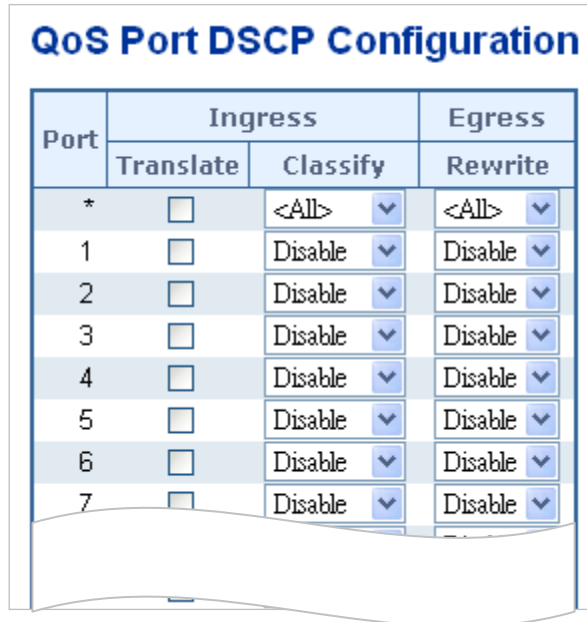

Port	Ingress		Egress
	Translate	Classify	Rewrite
*	<input type="checkbox"/>	<All> ▾	<All> ▾
1	<input type="checkbox"/>	Disable ▾	Disable ▾
2	<input type="checkbox"/>	Disable ▾	Disable ▾
3	<input type="checkbox"/>	Disable ▾	Disable ▾
4	<input type="checkbox"/>	Disable ▾	Disable ▾
5	<input type="checkbox"/>	Disable ▾	Disable ▾
6	<input type="checkbox"/>	Disable ▾	Disable ▾
7	<input type="checkbox"/>	Disable ▾	Disable ▾

Figure 4-4-4-1: QoS Port DSCP Configuration Page Screenshot

The page includes the following fields:

Object	Description
<ul style="list-style-type: none"> <li>• <b>Port</b></li> </ul>	The Port column shows the list of ports for which you can configure dscp ingress and egress settings.
<ul style="list-style-type: none"> <li>• <b>Ingress</b></li> </ul>	<p>In Ingress settings you can change ingress translation and classification settings for individual ports.</p> <p>There are two configuration parameters available in Ingress:</p> <ul style="list-style-type: none"> <li>■ <b>Translate</b></li> <li>■ <b>Classify</b></li> </ul>
<ul style="list-style-type: none"> <li>• <b>Translate</b></li> </ul>	To Enable the Ingress Translation click the checkbox.
<ul style="list-style-type: none"> <li>• <b>Classify</b></li> </ul>	<p>Classification for a port have 4 different values.</p> <ul style="list-style-type: none"> <li>■ <b>Disable</b>: No Ingress DSCP Classification.</li> <li>■ <b>DSCP=0</b>: Classify if incoming (or translated if enabled) DSCP is 0.</li> <li>■ <b>Selected</b>: Classify only selected DSCP for which classification is enabled as specified in DSCP Translation window for the specific DSCP.</li> <li>■ <b>All</b>: Classify all DSCP.</li> </ul>
<ul style="list-style-type: none"> <li>• <b>Egress</b></li> </ul>	<p>Port Egress Rewriting can be one of -</p> <ul style="list-style-type: none"> <li>■ <b>Disable</b>: No Egress rewrite.</li> <li>■ <b>Enable</b>: Rewrite enable without remapped.</li> </ul>

---

	<ul style="list-style-type: none"><li>■ <b>Remap DP Unaware:</b> DSCP from analyzer is remapped and frame is remarked with remapped DSCP value. The remapped DSCP value is always taken from the 'DSCP Translation-&gt;Egress Remap DP0' table.</li><li>■ <b>Remap DP Aware:</b> DSCP from analyzer is remapped and frame is remarked with remapped DSCP value. Depending on the DP level of the frame, the remapped DSCP value is either taken from the 'DSCP Translation-&gt;Egress Remap DP0' table or from the 'DSCP Translation-&gt;Egress Remap DP1' table.</li></ul>
--	---

---

**Buttons**



: Click to apply changes



: Click to undo any changes made locally and revert to previously saved values.

#### 4.4.4.2 DSCP-based QoS

This page allows you to configure the basic QoS DSCP-based QoS Ingress Classification settings for all switches. The DSCP-based QoS screen in [Figure 4-4-4-2](#) appears.

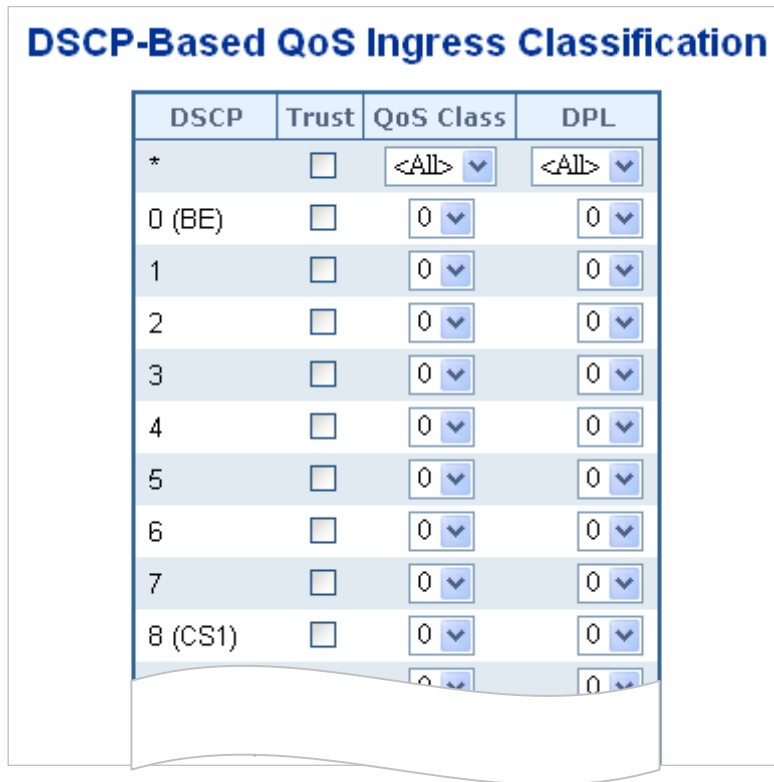

Figure 4-4-4-2: DSCP-based QoS Ingress Classification Page Screenshot

The page includes the following fields:

Object	Description
• <b>DSCP</b>	Maximum number of supported DSCP values are 64.
• <b>Trust</b>	Controls whether a specific DSCP value is trusted. Only frames with trusted DSCP values are mapped to a specific QoS class and Drop Precedence Level. Frames with untrusted DSCP values are treated as a non-IP frame.
• <b>QoS Class</b>	QoS Class value can be any of (0-7)
• <b>DPL</b>	Drop Precedence Level (0-1)

#### 4.4.4.3 DSCP Translation

This page allows you to configure the basic QoS DSCP Translation settings for all switches. DSCP translation can be done in

Ingress or Egress. The DSCP Translation screen in [Figure 4-4-4-3](#) appears.

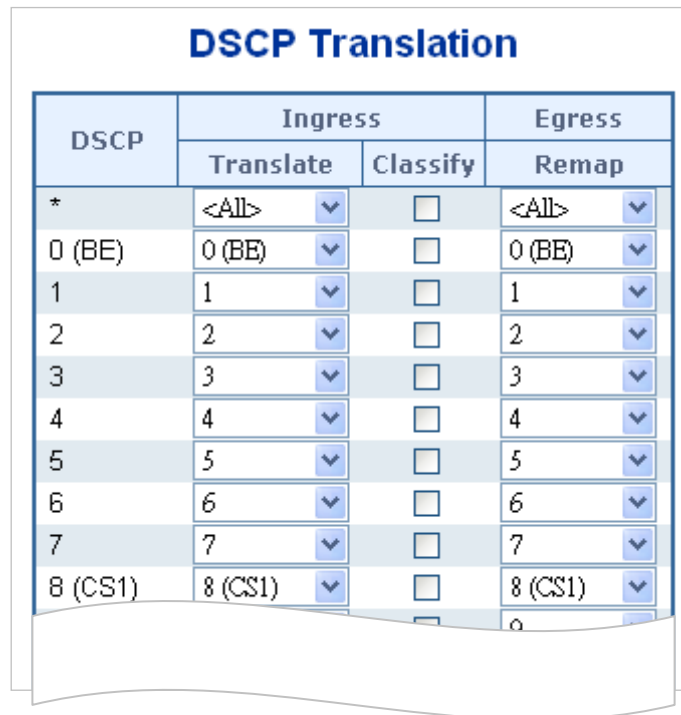



**Figure 4-4-4-3:** DSCP Translation Page Screenshot

The page includes the following fields:

Object	Description
• <b>DSCP</b>	Maximum number of supported DSCP values are 64 and valid DSCP value ranges from 0 to 63.
• <b>Ingress</b>	Ingress side DSCP can be first translated to new DSCP before using the DSCP for QoS class and DPL map. There are two configuration parameters for DSCP Translation – <ul style="list-style-type: none"> <li>■ <b>Translate</b></li> <li>■ <b>Classify</b></li> </ul>
• <b>Translate</b>	DSCP at Ingress side can be translated to any of (0-63) DSCP values.
• <b>Classify</b>	Click to enable Classification at Ingress side.
• <b>Egress</b>	There is following configurable parameter for Egress side - <ul style="list-style-type: none"> <li>■ <b>Remap</b></li> </ul>
• <b>Remap DP</b>	Select the DSCP value from select menu to which you want to remap. DSCP value ranges form 0 to 63.

**Buttons**

 : Click to apply changes

 : Click to undo any changes made locally and revert to previously saved values.

#### 4.4.4.4 DSCP Classification

This page allows you to map DSCP value to a QoS Class and DPL value. The DSCP Classification screen in [Figure 4-4-4-4](#) appears.

### DSCP Classification

CoS	DSCP DP0	DSCP DP1	DSCP DP2	DSCP DP3
*	<All> ▼	<All> ▼	<All> ▼	<All> ▼
0	0 (BE) ▼	0 (BE) ▼	0 (BE) ▼	0 (BE) ▼
1	0 (BE) ▼	0 (BE) ▼	0 (BE) ▼	0 (BE) ▼
2	0 (BE) ▼	0 (BE) ▼	0 (BE) ▼	0 (BE) ▼
3	0 (BE) ▼	0 (BE) ▼	0 (BE) ▼	0 (BE) ▼
4	0 (BE) ▼	0 (BE) ▼	0 (BE) ▼	0 (BE) ▼
5	0 (BE) ▼	0 (BE) ▼	0 (BE) ▼	0 (BE) ▼
6	0 (BE) ▼	0 (BE) ▼	0 (BE) ▼	0 (BE) ▼
7	0 (BE) ▼	0 (BE) ▼	0 (BE) ▼	0 (BE) ▼

**Figure 4-4-4-4:** DSCP Classification Page Screenshot

The page includes the following fields:

Object	Description
<ul style="list-style-type: none"> <li>• <b>QoS Class</b></li> </ul>	Available QoS Class value ranges from 0 to 7. QoS Class (0-7) can be mapped to followed parameters.
<ul style="list-style-type: none"> <li>• <b>DPL</b></li> </ul>	Actual Drop Precedence Level.
<ul style="list-style-type: none"> <li>• <b>DSCP</b></li> </ul>	Select DSCP value (0-63) from DSCP menu to map DSCP to corresponding QoS Class and DPL value

#### Buttons

: Click to apply changes

: Click to undo any changes made locally and revert to previously saved values.



## 4.4.5 QCL

### 4.4.5.1 QoS Control List

This page shows the QoS Control List(QCL), which is made up of the QCEs. Each row describes a QCE that is defined. The maximum number of QCEs is 256 on each switch.

Click on the lowest plus sign to add a new QCE to the list. The QoS Control List screen in [Figure 4-4-5-1](#) appears.



Figure 4-4-5-1: QoS Control List Configuration Page Screenshot

The page includes the following fields:

Object	Description
• <b>QCE#</b>	Indicates the index of QCE.
• <b>Port</b>	Indicates the list of ports configured with the QCE.
• <b>DMAC</b>	Specify the type of Destination MAC addresses for incoming frame. Possible values are: <ul style="list-style-type: none"> <li>■ <b>Any</b>: All types of Destination MAC addresses are allowed.</li> <li>■ <b>Unicast</b>: Only Unicast MAC addresses are allowed.</li> <li>■ <b>Multicast</b>: Only Multicast MAC addresses are allowed.</li> <li>■ <b>Broadcast</b>: Only Broadcast MAC addresses are allowed.</li> </ul> The default value is 'Any'.
• <b>SMAC</b>	Displays the OUI field of Source MAC address, i.e. first three octet (byte) of MAC address.
• <b>Tag Type</b>	Indicates tag type. Possible values are: <ul style="list-style-type: none"> <li>■ <b>Any</b>: Match tagged and untagged frames.</li> <li>■ <b>Untagged</b>: Match untagged frames.</li> <li>■ <b>Tagged</b>: Match tagged frames.</li> </ul> The default value is 'Any'
• <b>VID</b>	Indicates (VLAN ID), either a specific VID or range of VIDs. VID can be in the range 1-4095 or 'Any'
• <b>PCP</b>	Priority Code Point: Valid value PCP are specific(0, 1, 2, 3, 4, 5, 6, 7) or range(0-1, 2-3, 4-5, 6-7, 0-3, 4-7) or 'Any'.
• <b>DEI</b>	Drop Eligible Indicator: Valid value of DEI can be any of values between 0, 1 or 'Any'.

<ul style="list-style-type: none"> <li>• <b>Frame Type</b></li> </ul>	<p>Indicates the type of frame to look for incoming frames. Possible frame types are:</p> <ul style="list-style-type: none"> <li>■ <b>Any</b>: The QCE will match all frame type.</li> <li>■ <b>Ethernet</b>: Only Ethernet frames (with Ether Type 0x600-0xFFFF) are allowed.</li> <li>■ <b>LLC</b>: Only (LLC) frames are allowed.</li> <li>■ <b>SNAP</b>: Only (SNAP) frames are allowed.</li> <li>■ <b>IPv4</b>: The QCE will match only IPV4 frames.</li> <li>■ <b>IPv6</b>: The QCE will match only IPV6 frames.</li> </ul>
<ul style="list-style-type: none"> <li>• <b>Action</b></li> </ul>	<p>Indicates the classification action taken on ingress frame if parameters configured are matched with the frame's content.</p> <p>There are seven action fields:</p> <ul style="list-style-type: none"> <li>■ <b>Class</b>: Classified QoS class.</li> <li>■ <b>DPL</b>: Classified Drop Precedence Level.</li> <li>■ <b>DSCP</b>: Classified DSCP value.</li> <li>■ <b>PCP</b>: Classify PCP value.</li> <li>■ <b>DEI</b>: Classify DEI value.</li> <li>■ <b>Policy</b>: Classify ACL Policy number.</li> <li>■ <b>Ingress Map</b>: Classify Ingress Map ID.</li> </ul>
<ul style="list-style-type: none"> <li>• <b>Modification Buttons</b></li> </ul>	<p>You can modify each QCE in the table using the following buttons:</p> <ul style="list-style-type: none"> <li>⊕: Inserts a new QCE before the current row.</li> <li>ⓔ: Edits the QCE.</li> <li>⬆: Moves the QCE up the list.</li> <li>⬇: Moves the QCE down the list.</li> <li>⊗: Deletes the QCE.</li> <li>⊕: The lowest plus sign adds a new entry at the bottom of the list of QCL.</li> </ul>

### 4.4.5.2 QoS Control Entry Configuration

The QCE Configuration screen in [Figure 4-4-5-2](#) appears.

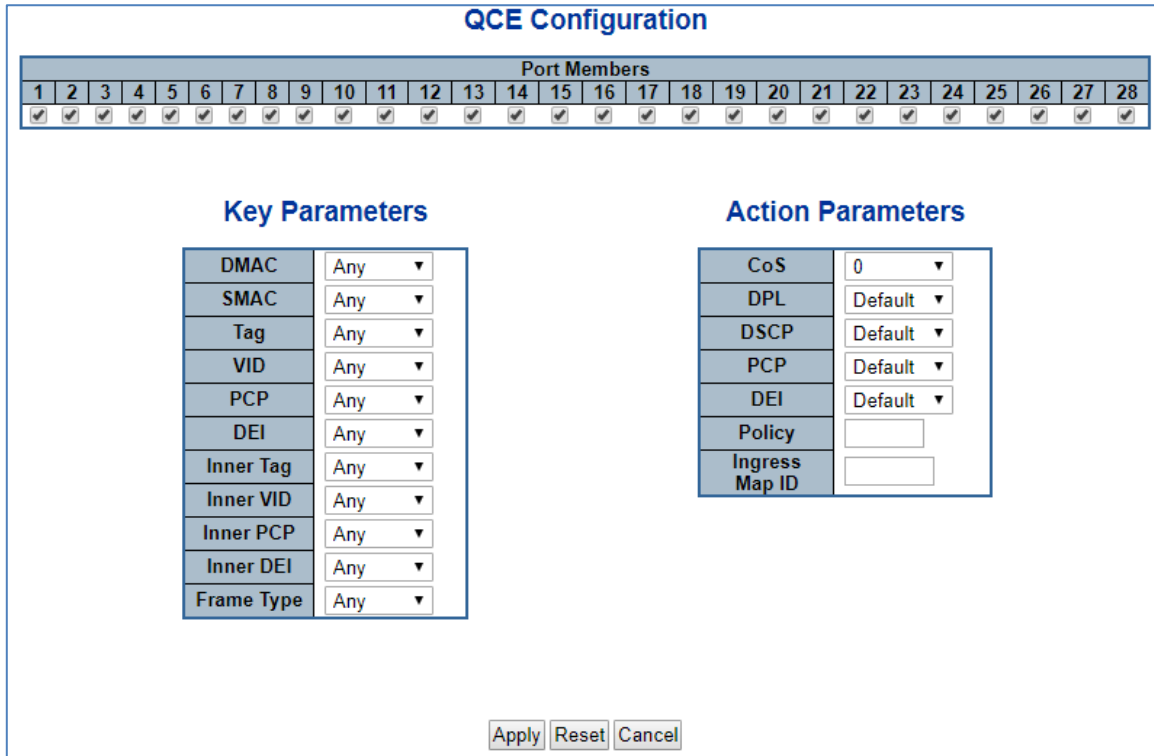

Figure 4-4-5-2: QCE Configuration Page Screenshot

The page includes the following fields:

Object	Description
<ul style="list-style-type: none"> <li>• <b>Port Members</b></li> </ul>	<p>Check the checkbox button in case you want to make any port member of the QCL entry. By default all ports will be checked</p>
<ul style="list-style-type: none"> <li>• <b>Key Parameters</b></li> </ul>	<p>Key configuration are described as below:</p> <ul style="list-style-type: none"> <li>■ <b>DMAC Type</b> Destination MAC type: possible values are unicast(UC), multicast(MC), broadcast(BC) or 'Any'</li> <li>■ <b>SMAC</b> Source MAC address: 24 MS bits (OUI) or 'Any'</li> <li>■ <b>Tag</b> Value of Tag field can be 'Any', 'Untag' or 'Tag'</li> <li>■ <b>VID</b> Valid value of VLAN ID can be any value in the range 1-4095 or 'Any'; user can enter either a specific value or a range of VIDs</li> <li>■ <b>PCP</b> Priority Code Point: Valid value PCP are specific(0, 1, 2, 3, 4, 5, 6, 7) or range(0-1, 2-3, 4-5, 6-7, 0-3, 4-7) or 'Any'</li> <li>■ <b>DEI</b> Drop Eligible Indicator: Valid value of DEI can be any of values between 0, 1 or 'Any'</li> <li>■ <b>Frame Type</b> Frame Type can have any of the following values               <ol style="list-style-type: none"> <li>1. <b>Any</b></li> <li>2. <b>Ethernet</b></li> <li>3. <b>LLC</b></li> </ol> </li> </ul>

	<p>4. <b>SNAP</b></p> <p>5. <b>IPv4</b></p> <p>6. <b>IPv6</b></p> <p><b>Note:</b> all frame types are explained below.</p>
• Any	Allow all types of frames.
• EtherType	<b>Ethernet Type</b> Valid Ethernet type can have value within 0x600-0xFFFF or 'Any' but excluding 0x800(IPv4) and 0x86DD(IPv6), default value is 'Any'.
• LLC	<p>■ <b>SSAP Address</b> Valid SSAP(Source Service Access Point) can vary from 0x00 to 0xFF or 'Any', the default value is 'Any'</p> <p>■ <b>DSAP Address</b> Valid DSAP(Destination Service Access Point) can vary from 0x00 to 0xFF or 'Any', the default value is 'Any'</p> <p>■ <b>Control Address</b> Valid Control Address can vary from 0x00 to 0xFF or 'Any', the default value is 'Any'</p>
• SNAP	<b>PID</b> Valid PID(a.k.a Ethernet type) can have value within 0x00-0xFFFF or 'Any', default value is 'Any'
• IPv4	<p>■ <b>Protocol</b> IP protocol number: (0-255, TCP or UDP) or 'Any'</p> <p>■ <b>Source IP</b> Specific Source IP address in value/mask format or 'Any'. IP and Mask are in the format x.y.z.w where x, y, z, and w are decimal numbers between 0 and 255. When Mask is converted to a 32-bit binary string and read from left to right, all bits following the first zero must also be zero</p> <p><b>DSCP</b> Diffserv Code Point value(DSCP): It can be specific value, range of value or 'Any'. DSCP values are in the range 0-63 including BE, CS1-CS7, EF or AF11-AF43</p> <p>■ <b>IP Fragment</b> IPv4 frame fragmented option: yes no any</p> <p>■ <b>Sport</b> Source TCP/UDP port:(0-65535) or 'Any', specific or port range applicable for IP protocol UDP/TCP</p> <p>■ <b>Dport</b> Destination TCP/UDP port:(0-65535) or 'Any', specific or port range applicable for IP protocol UDP/TCP</p>
• IPv6	<p><b>Protocol</b> IP protocol number: (0-255, TCP or UDP) or 'Any'</p> <p><b>Source IP</b> IPv6 source address: (a.b.c.d) or 'Any', 32 LS bits</p> <p><b>DSCP</b> Diffserv Code Point value(DSCP): It can be specific value, range of value or 'Any'. DSCP values are in the range 0-63 including BE, CS1-CS7, EF or AF11-AF43</p> <p><b>Sport</b> Source TCP/UDP port:(0-65535) or 'Any', specific or port range applicable for IP protocol UDP/TCP</p> <p><b>Dport</b> Destination TCP/UDP port:(0-65535) or 'Any', specific or port range applicable for IP protocol UDP/TCP</p>
• Action Parameters	<p><b>Class</b> QoS class: (0-7) or 'Default'.</p> <p><b>DPL</b> Valid Drop Precedence Level can be (0-3) or 'Default'.</p>

	<p><b>DSCP</b> Valid DSCP value can be (0-63, BE, CS1-CS7, EF or AF11-AF43) or 'Default'.</p> <p>'Default' means that the default classified value is not modified by this QCE.</p>
--	---

**Buttons**

**Apply** : Click to apply changes

**Reset** : Click to undo any changes made locally and revert to previously saved values

**Cancel** : Return to the previous page without saving the configuration change

**4.4.5.3 QCL Status**

This page shows the QCL status by different QCL users. Each row describes the QCE that is defined. It is a conflict if a specific QCE is not applied to the hardware due to hardware limitations. The maximum number of QCEs is **256** on each switch. The QoS Control List Status screen in [Figure 4-4-5-3](#) appears.

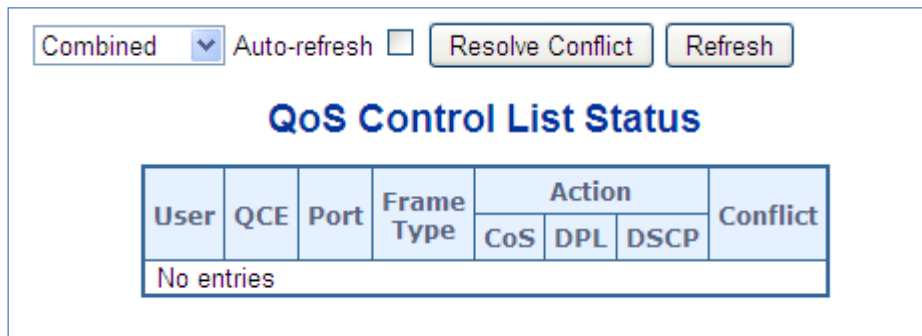

**Figure 4-4-5-3:** QoS Control List Status Page Screenshot

The page includes the following fields:

Object	Description
• <b>User</b>	Indicates the QCL user.
• <b>QCE#</b>	Indicates the index of QCE.
• <b>Port</b>	Indicates the list of ports configured with the QCE.
• <b>Frame Type</b>	<p>Indicates the type of frame to look for incoming frames. Possible frame types are:</p> <ul style="list-style-type: none"> <li>■ <b>Any</b>: The QCE will match all frame types.</li> <li>■ <b>Ethernet</b>: Only Ethernet frames (with Ether Type 0x600-0xFFFF) are allowed.</li> <li>■ <b>LLC</b>: Only (LLC) frames are allowed.</li> <li>■ <b>SNAP</b>: Only (SNAP) frames are allowed.</li> </ul>

	<ul style="list-style-type: none"> <li>■ <b>IPv4</b>: The QCE will match only IPV4 frames.</li> <li>■ <b>IPv6</b>: The QCE will match only IPV6 frames.</li> </ul>
<ul style="list-style-type: none"> <li>• <b>Action</b></li> </ul>	<p>Indicates the classification action taken on ingress frame if parameters configured are matched with the frame's content.</p> <p>There are three action fields: Class, DPL and DSCP.</p> <ul style="list-style-type: none"> <li>■ <b>Class</b>: Classified QoS class; if a frame matches the QCE it will be put in the queue.</li> <li>■ <b>DPL</b>: Drop Precedence Level; if a frame matches the QCE then DP level will set to value displayed under DPL column.</li> <li>■ <b>DSCP</b>: If a frame matches the QCE then DSCP will be classified with the value displayed under DSCP column.</li> </ul>
<ul style="list-style-type: none"> <li>• <b>Conflict</b></li> </ul>	<p>Displays Conflict status of QCL entries. As H/W resources are shared by multiple applications. It may happen that resources required to add a QCE may not be available, in that case it shows conflict status as 'Yes', otherwise it is always 'No'.</p> <p>Please note that conflict can be resolved by releasing the H/W resources required to add QCL entry on pressing 'Resolve Conflict' button.</p>

**Buttons**

: Select the QCL status from this drop down list.

Auto-refresh : Check this box to refresh the page automatically. Automatic refresh occurs every 3 seconds.

: Click to release the resources required to add QCL entry, in case the conflict status for any QCL entry is 'yes'.

: Click to refresh the page.

#### 4.4.5.4 Voice VLAN Configuration

The Voice VLAN feature enables voice traffic forwarding on the Voice VLAN, then the switch can classify and schedule network traffic. It is recommended that there be two VLANs on a port - one for voice, one for data.

Before connecting the IP device to the switch, the IP phone should configure the voice VLAN ID correctly. It should be configured through its own GUI. The Voice VLAN Configuration screen in [Figure 4-4-5-4](#) appears.

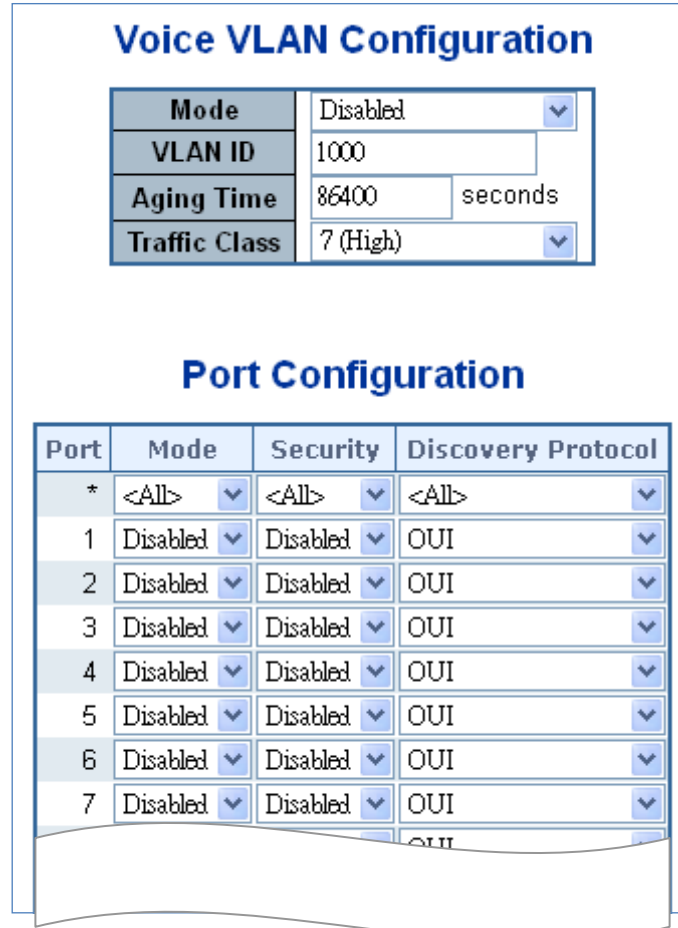

Figure 4-4-5-4: Voice VLAN Configuration Page Screenshot

The page includes the following fields:

Object	Description
<ul style="list-style-type: none"> <li>• <b>Mode</b></li> </ul>	<p>Indicates the Voice VLAN mode operation. We must disable MSTP feature before we enable Voice VLAN. It can avoid the conflict of ingress filter. Possible modes are:</p> <ul style="list-style-type: none"> <li>■ <b>Enabled:</b> Enable Voice VLAN mode operation.</li> <li>■ <b>Disabled:</b> Disable Voice VLAN mode operation.</li> </ul>
<ul style="list-style-type: none"> <li>• <b>VLAN ID</b></li> </ul>	<p>Indicates the Voice VLAN ID. It should be a unique VLAN ID in the system and cannot equal each port PVID. It is conflict configuration if the value equal management VID, MVR VID, PVID etc.</p>

	The allowed range is 1 to 4095.
<ul style="list-style-type: none"> <li>• <b>Aging Time</b></li> </ul>	<p>Indicates the Voice VLAN secure learning age time. The allowed range is 10 to 10000000 seconds. It used when security mode or auto detect mode is enabled. In other cases, it will based hardware age time.</p> <p>The actual age time will be situated in the [age_time; 2 * age_time] interval.</p>
<ul style="list-style-type: none"> <li>• <b>Traffic Class</b></li> </ul>	Indicates the Voice VLAN traffic class. All traffic on Voice VLAN will apply this class.
<ul style="list-style-type: none"> <li>• <b>Mode</b></li> </ul>	<p>Indicates the Voice VLAN port mode.</p> <p>Possible port modes are:</p> <ul style="list-style-type: none"> <li>■ <b>Disabled:</b> Disjoin from Voice VLAN.</li> <li>■ <b>Auto:</b> Enable auto detect mode. It detects whether there is VoIP phone attached to the specific port and configures the Voice VLAN members automatically.</li> <li>■ <b>Forced:</b> Force join to Voice VLAN.</li> </ul>
<ul style="list-style-type: none"> <li>• <b>Port Security</b></li> </ul>	<p>Indicates the Voice VLAN port security mode. When the function is enabled, all non-telephone MAC address in Voice VLAN will be blocked 10 seconds. Possible port modes are:</p> <ul style="list-style-type: none"> <li>■ <b>Enabled:</b> Enable Voice VLAN security mode operation.</li> <li>■ <b>Disabled:</b> Disable Voice VLAN security mode operation.</li> </ul>
<ul style="list-style-type: none"> <li>• <b>Port Discovery Protocol</b></li> </ul>	<p>Indicates the Voice VLAN port discovery protocol. It will only work when auto detect mode is enabled. We should enable LLDP feature before configuring discovery protocol to "LLDP" or "Both". Changing the discovery protocol to "OUI" or "LLDP" will restart auto detect process. Possible discovery protocols are:</p> <ul style="list-style-type: none"> <li>■ <b>OUI:</b> Detect telephony device by OUI address.</li> <li>■ <b>LLDP:</b> Detect telephony device by LLDP.</li> <li>■ <b>Both:</b> Both OUI and LLDP.</li> </ul>



#### 4.4.5.5 Voice VLAN OUI Table

Configure VOICE VLAN OUI table on this page. The maximum entry number is 16. Modifying the OUI table will restart auto detection of OUI process. The Voice VLAN OUI Table screen in [Figure 4-4-5-5](#) appears.

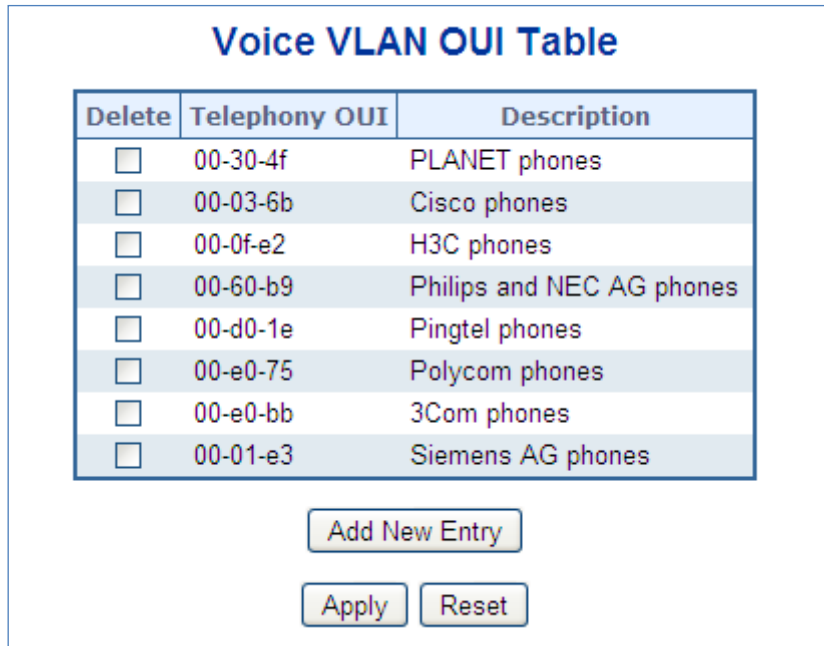

Figure 4-4-5-5: Voice VLAN OUI Table Page Screenshot

The page includes the following fields:

Object	Description
<ul style="list-style-type: none"> <li>• <b>Delete</b></li> </ul>	Check to delete the entry. It will be deleted during the next save.
<ul style="list-style-type: none"> <li>• <b>Telephony OUI</b></li> </ul>	An telephony OUI address is a globally unique identifier assigned to a vendor by IEEE. It must be 6 characters long and the input format is "xx-xx-xx" (x is a hexadecimal digit).
<ul style="list-style-type: none"> <li>• <b>Description</b></li> </ul>	The description of OUI address. Normally, it describes which vendor telephony device it belongs to. The allowed string length is 0 to 32.

#### Buttons

: Click to add a new access management entry.

: Click to apply changes

: Click to undo any changes made locally and revert to previously saved values.

## 4.5 Security

### 4.5.1 Access Security

#### 4.5.1.1 Access Management

Configure access management table on this page. The maximum entry number is 16. If the application's type match any one of the access management entries, it will allow access to the switch. The Access Management Configuration screen in [Figure 4-5-1-1](#) appears.

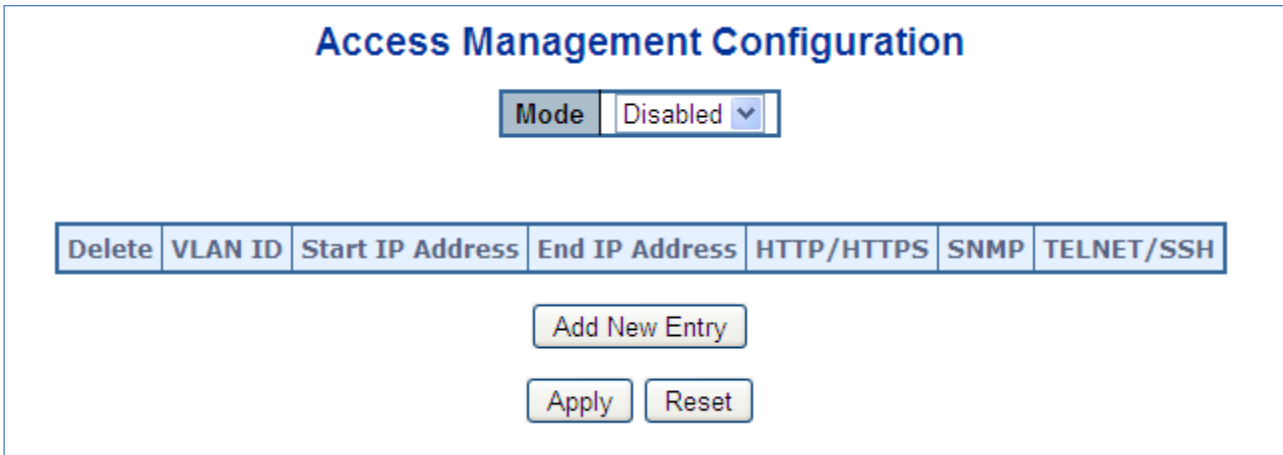

Figure 4-5-1-1: Access Management Configuration Overview Page Screenshot

The page includes the following fields:

Object	Description
<ul style="list-style-type: none"> <li>• <b>Mode</b></li> </ul>	Indicates the access management mode operation. Possible modes are: <b>Enabled:</b> Enable access management mode operation. <b>Disabled:</b> Disable access management mode operation.
<ul style="list-style-type: none"> <li>• <b>Delete</b></li> </ul>	Check to delete the entry. It will be deleted during the next apply .
<ul style="list-style-type: none"> <li>• <b>VLAN ID</b></li> </ul>	Indicates the VLAN ID for the access management entry.
<ul style="list-style-type: none"> <li>• <b>Start IP address</b></li> </ul>	Indicates the start IP address for the access management entry.
<ul style="list-style-type: none"> <li>• <b>End IP address</b></li> </ul>	Indicates the end IP address for the access management entry.
<ul style="list-style-type: none"> <li>• <b>HTTP/HTTPS</b></li> </ul>	Indicates the host can access the switch from HTTP/HTTPS interface that the host IP address matched the entry.
<ul style="list-style-type: none"> <li>• <b>SNMP</b></li> </ul>	Indicates the host can access the switch from SNMP interface that the host IP address matched the entry.
<ul style="list-style-type: none"> <li>• <b>Telnet/SSH</b></li> </ul>	Indicates the host can access the switch from TELNET/SSH interface that the host IP address matched the entry.

**Buttons**

**Add New Entry** : Click to add a new access management entry.

**Apply** : Click to apply changes

**Reset** : Click to undo any changes made locally and revert to previously saved values.

**4.5.1.2 Access Management Statistics**

This page provides statistics for access management. The Access Management Statistics screen in [Figure 4-5-1-2](#) appears.

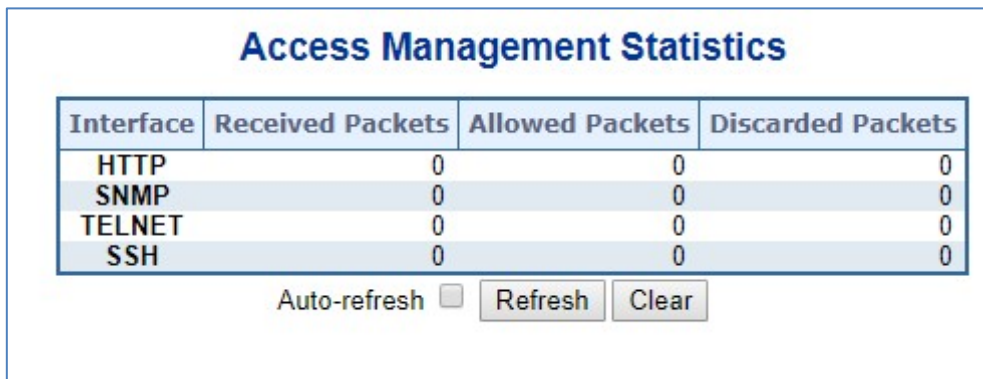

Interface	Received Packets	Allowed Packets	Discarded Packets
HTTP	0	0	0
SNMP	0	0	0
TELNET	0	0	0
SSH	0	0	0

Auto-refresh  Refresh Clear

**Figure 4-5-1-2:** Access Management Statistics Overview Page Screenshot

The page includes the following fields:

Object	Description
• <b>Interface</b>	The interface that allowed remote host can access the switch.
• <b>Receive Packets</b>	The received packets number from the interface under access management mode is enabled.
• <b>Allow Packets</b>	The allowed packets number from the interface under access management mode is enabled.
• <b>Discard Packets</b>	The discarded packets number from the interface under access management mode is enabled.

**Buttons**

Auto-refresh  Check this box to refresh the page automatically. Automatic refresh occurs every 3 seconds.

**Refresh** : Click to refresh the page immediately.

**Clear** : Clears all statistics.



### 4.5.1.3 SSH

Configure SSH on this page. This page shows the Port Security status. Port Security is a module with no direct configuration. Configuration comes indirectly from other modules - the user modules. When a user module has enabled port security on a port, the port is set-up for software-based learning. In this mode, frames from unknown MAC addresses are passed on to the port security module, which in turn asks all user modules whether to allow this new MAC address to forward or block it. For a MAC address to be set in the forwarding state, all enabled user modules must unanimously agree on allowing the MAC address to forward. If only one chooses to block it, it will be blocked until that user module decides otherwise.

The status page is divided into two sections - one with a legend of user modules and one with the actual port status. The SSH Configuration screen in [Figure 4-5-1-3](#) appears.

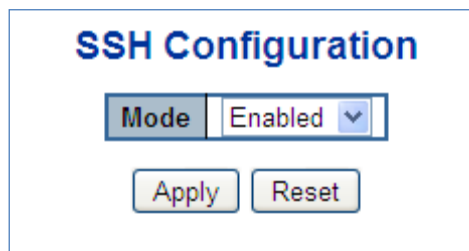



**Figure 4-5-1-3:** SSH Configuration Screen Page Screenshot

The page includes the following fields:

Object	Description
<ul style="list-style-type: none"> <li>• <b>Mode</b></li> </ul>	Indicates the SSH mode operation. Possible modes are: <ul style="list-style-type: none"> <li>■ <b>Enabled:</b> Enable SSH mode operation.</li> <li>■ <b>Disabled:</b> Disable SSH mode operation.</li> </ul>

#### Buttons

 : Click to apply changes

 : Click to undo any changes made locally and revert to previously saved values.

#### 4.5.1.4 HTTPS

Configure HTTPS on this page. The HTTPS Configuration screen in [Figure 4-5-1-4](#) appears.

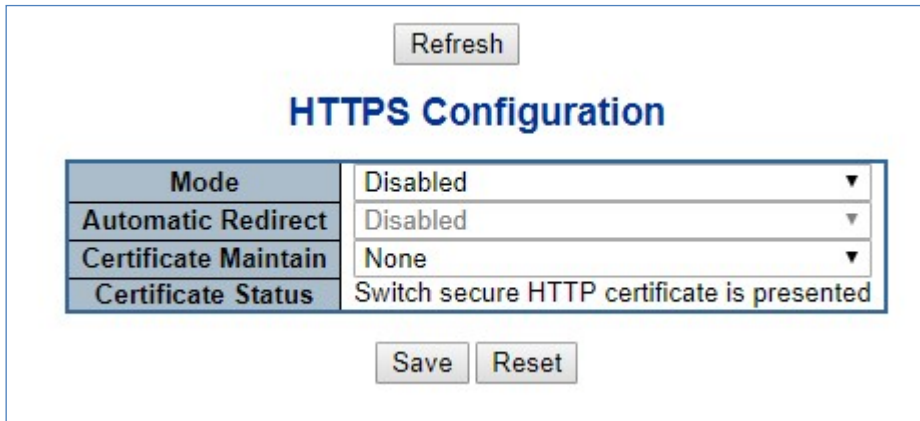

**Figure 4-5-1-4:** HTTPS Configuration Screen Page Screenshot

The page includes the following fields:

Object	Description
<ul style="list-style-type: none"> <li>• <b>Mode</b></li> </ul>	<p>Indicates the HTTPS mode operation. When the current connection is HTTPS, to apply HTTPS disabled mode operation will automatically redirect web browser to an HTTP connection. Possible modes are:</p> <ul style="list-style-type: none"> <li>■ <b>Enabled:</b> Enable HTTPS mode operation.</li> <li>■ <b>Disabled:</b> Disable HTTPS mode operation.</li> </ul>
<ul style="list-style-type: none"> <li>• <b>Automatic Redirect</b></li> </ul>	<p>Indicates the HTTPS redirect mode operation. It only significant if HTTPS mode "Enabled" is selected. Automatically redirects web browser to an HTTPS connection when both HTTPS mode and Automatic Redirect are enabled or redirects web browser to an HTTP connection when both are disabled. Possible modes are:</p> <ul style="list-style-type: none"> <li>■ <b>Enabled:</b> Enable HTTPS redirect mode operation.</li> <li>■ <b>Disabled:</b> Disable HTTPS redirect mode operation.</li> </ul>
<ul style="list-style-type: none"> <li>• <b>Certificate Maintain</b></li> </ul>	<p>The operation of certificate maintenance.</p> <p>Possible operations are:</p> <p><b>None:</b> No operation.</p> <p><b>Delete:</b> Delete the current certificate.</p> <p><b>Upload:</b> Upload a certificate PEM file. Possible methods are: <b>Web Browser</b> or <b>URL</b>.</p> <p><b>Generate:</b> Generate a new self-signed RSA certificate.</p>
<ul style="list-style-type: none"> <li>• <b>Certificate Pass Phrase</b></li> </ul>	<p>Enter the pass phrase in this field if your uploading certificate is protected by a specific passphrase.</p>

<ul style="list-style-type: none"> <li>• <b>Certificate Upload</b></li> </ul>	<p>Upload a certificate PEM file into the switch. The file should contain the certificate and private key together. If you have two separated files for saving certificate and private key. Use the Linux cat command to combine them into a single PEM file. For example, <code>cat my.cert my.key &gt; my.pem</code></p> <p>Notice that the RSA certificate is recommended since most of the new version of browsers has removed support for DSA in certificate, e.g. Firefox v37 and Chrome v39.</p> <p>Possible methods are:</p> <p><b>Web Browser:</b> Upload a certificate via Web browser.</p> <p><b>URL:</b> Upload a certificate via URL, the supported protocols are <a href="#">HTTP</a>, <a href="#">HTTPS</a>, <a href="#">FTTP</a> and <a href="#">FTP</a>. The URL format is <code>&lt;protocol&gt;://[&lt;username&gt;[:&lt;password&gt;]@]&lt;host&gt;[:&lt;port&gt;][/&lt;path&gt;]/&lt;file_name&gt;</code>. For example, <code>fttp://10.10.10.10/new_image_path/new_image.dat</code>, <code>http://username:password@10.10.10.10:80/new_image_path/new_image.dat</code>. A valid file name is a text string drawn from alphabet (A-Za-z), digits (0-9), dot (.), hyphen (-), under score(_). The maximum length is 63 and hyphen must not be first character. The file name content that only contains '.' is not allowed.</p>
<ul style="list-style-type: none"> <li>• <b>Certificate Status</b></li> </ul>	<p>Display the current status of certificate on the switch.</p> <p>Possible statuses are:</p> <pre>Switch secure HTTP certificate is presented. Switch secure HTTP certificate is not presented. Switch secure HTTP certificate is generating ...</pre>

**Buttons**

**Save** : Click to save changes.

**Reset** : Click to undo any changes made locally and revert to previously saved values.

**Refresh** : Click to refresh the page. Any changes made locally will be undone.

## 4.5.2 AAA

This section is to control the access to the **Industrial Managed Switch**, including the user access and management control.

The Authentication section contains links to the following main topics:

- **User Authentication**
- **IEEE 802.1X Port-based Network Access Control**
- **MAC-based Authentication**

### Overview of 802.1X (Port-Based) Authentication

In the 802.1X-world, the user is called the supplicant, the switch is the authenticator, and the RADIUS server is the authentication server. The switch acts as the man-in-the-middle, forwarding requests and responses between the supplicant and the authentication server. Frames sent between the supplicant and the switch are special 802.1X frames, known as **EAPOL (EAP Over LANs)** frames. EAPOL frames encapsulate **EAP PDUs** (RFC3748). Frames sent between the switch and the RADIUS server are RADIUS packets. RADIUS packets also encapsulate EAP PDUs together with other attributes like the switch's IP address, name, and the supplicant's port number on the switch. EAP is very flexible, in that it allows for different authentication methods, like **MD5-Challenge**, **PEAP**, and **TLS**. The important thing is that the authenticator (the switch) doesn't need to know which authentication method the supplicant and the authentication server are using, or how many information exchange frames are needed for a particular method. The switch simply encapsulates the EAP part of the frame into the relevant type (EAPOL or RADIUS) and forwards it.

When authentication is complete, the RADIUS server sends a special packet containing a success or failure indication. Besides forwarding this decision to the supplicant, the switch uses it to open up or block traffic on the switch port connected to the supplicant.

### Overview of MAC-based Authentication

Unlike 802.1X, MAC-based authentication is not a standard, but merely a best-practices method adopted by the industry. In MAC-based authentication, users are called clients, and the switch acts as the supplicant on behalf of clients. The initial frame (any kind of frame) sent by a client is snooped by the switch, which in turn uses the client's MAC address as both username and password in the subsequent EAP exchange with the RADIUS server. The 6-byte MAC address is converted to a string on the following form "xx-xx-xx-xx-xx-xx", that is, a dash (-) is used as separator between the lower-cased hexadecimal digits. The switch only supports the MD5-Challenge authentication method, so the RADIUS server must be configured accordingly.

When authentication is complete, the RADIUS server sends a success or failure indication, which in turn causes the switch to open up or block traffic for that particular client, using static entries into the MAC Table. Only then will frames from the client be forwarded on the switch. There are no EAPOL frames involved in this authentication, and therefore, MAC-based Authentication has nothing to do with the 802.1X standard.

The advantage of MAC-based authentication over 802.1X is that several clients can be connected to the same port (e.g. through a 3rd party switch or a hub) and still require individual authentication, and that the clients don't need special supplicant software to authenticate. The disadvantage is that MAC addresses can be spoofed by malicious users, equipment whose MAC



address is a valid RADIUS user can be used by anyone, and only the MD5-Challenge method is supported.

The 802.1X and MAC-Based Authentication configuration consists of two sections, a system- and a port-wide.

## Overview of User Authentication

It is allowed to configure the **Industrial Managed Switch** to authenticate users logging into the system for management access using local or remote authentication methods, such as telnet and Web browser. This **Industrial Managed Switch** provides secure network management access using the following options:

- **Remote Authentication Dial-in User Service (RADIUS)**
- **Terminal Access Controller Access Control System Plus (TACACS+)**
- **Local user name and Privilege Level control**

**RADIUS and TACACS+** are logon authentication protocols that use software running on a central server to control access to RADIUS-aware or TACACS-aware devices on the network. An **authentication server** contains a database of multiple user name / password pairs with associated privilege levels for each user that requires management access to the **Industrial Managed Switch**.

## Understanding IEEE 802.1X Port-based Authentication

The IEEE 802.1X standard defines a client-server-based access control and authentication protocol that restricts unauthorized clients from connecting to a LAN through publicly accessible ports. The authentication server authenticates each client connected to a switch port before making available any services offered by the switch or the LAN.

Until the client is authenticated, 802.1X access control allows only **Extensible Authentication Protocol over LAN (EAPOL)** traffic through the port to which the client is connected. After authentication is successful, normal traffic can pass through the port.

This section includes this conceptual information:

- Device Roles
- Authentication Initiation and Message Exchange
- Ports in Authorized and Unauthorized States

### ■ Device Roles

With 802.1X port-based authentication, the devices in the network have specific roles as shown below.

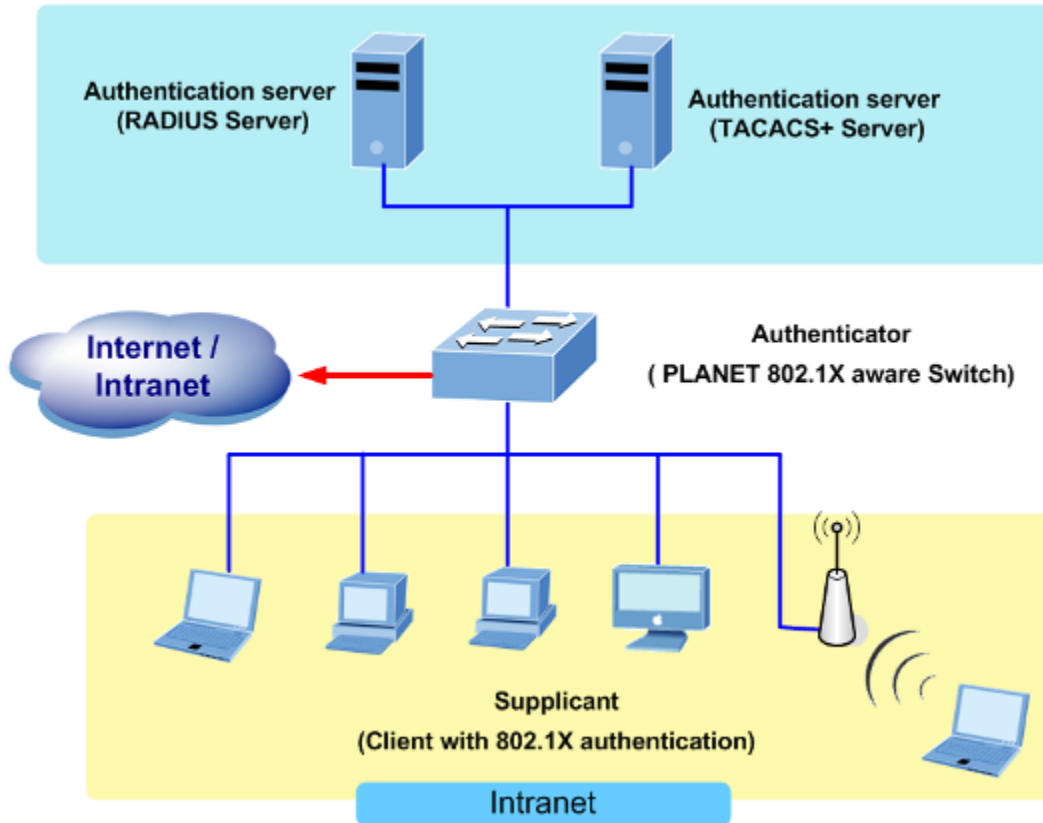

Figure 4-5-2-1

- **Client**—the device (workstation) that requests access to the LAN and switch services and responds to requests from the switch. The workstation must be running 802.1X-compliant client software such as that offered in the Microsoft Windows XP operating system. (The client is the *supplicant* in the IEEE 802.1X specification.)
- **Authentication server**—performs the actual authentication of the client. The authentication server validates the identity of the client and notifies the switch whether or not the client is authorized to access the LAN and switch services. Because the switch acts as the proxy, the authentication service is transparent to the client. In this release, the Remote Authentication Dial-In User Service (RADIUS) security system with **Extensible Authentication Protocol (EAP)** extensions is the only supported authentication server; it is available in Cisco Secure Access Control Server version 3.0. RADIUS operates in a client/server model in which secure authentication information is exchanged between the RADIUS server and one or more RADIUS clients.
- **Switch (802.1X device)**—controls the physical access to the network based on the authentication status of the client. The switch acts as an intermediary (proxy) between the client and the authentication server, requesting identity information from the client, verifying that information with the authentication server, and relaying a response to the client. The switch includes the RADIUS client, which is responsible for encapsulating and decapsulating the Extensible Authentication Protocol (EAP) frames and interacting with the authentication server. When the switch receives EAPOL frames and relays them to the authentication server, the Ethernet header is stripped and the remaining EAP frame is re-encapsulated in the RADIUS format. The EAP frames are not modified or examined during encapsulation, and the authentication server must support EAP within the native frame format. When the switch receives frames from the authentication server, the server's frame header is removed, leaving the EAP frame, which is then encapsulated for

Ethernet and sent to the client.

■ **Authentication Initiation and Message Exchange**

The switch or the client can initiate authentication. If you enable authentication on a port by using the **dot1x port-control auto** interface configuration command, the switch must initiate authentication when it determines that the port link state transitions from down to up. It then sends an EAP-request/identity frame to the client to request its identity (typically, the switch sends an initial identity/request frame followed by one or more requests for authentication information). Upon receipt of the frame, the client responds with an EAP-response/identity frame.

However, if during bootup, the client does not receive an EAP-request/identity frame from the switch, the client can initiate authentication by sending an EAPOL-start frame, which prompts the switch to request the client's identity



If 802.1X is not enabled or supported on the network access device, any EAPOL frames from the client are dropped. If the client does not receive an EAP-request/identity frame after three attempts to start authentication, the client transmits frames as if the port is in the authorized state. A port in the authorized state effectively means that the client has been successfully authenticated.

When the client supplies its identity, the switch begins its role as the intermediary, passing EAP frames between the client and the authentication server until authentication succeeds or fails. If the authentication succeeds, the switch port becomes authorized.

The specific exchange of EAP frames depends on the authentication method being used. "Figure 4-5-2" shows a message exchange initiated by the client using the One-Time-Password (OTP) authentication method with a RADIUS server.

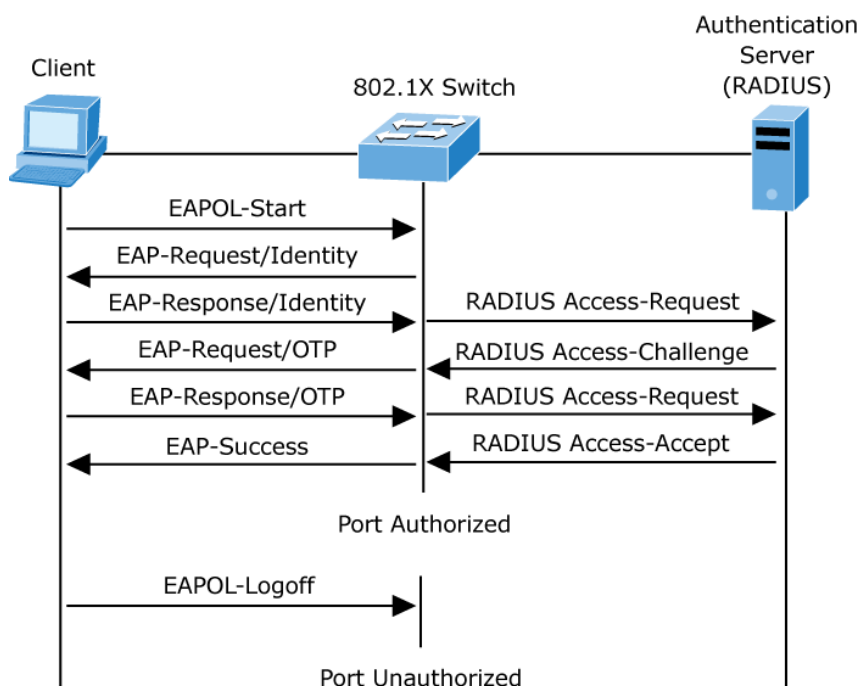

Figure 4-5-2-2: EAP Message Exchange

#### ■ Ports in Authorized and Unauthorized States

The switch port state determines whether or not the client is granted access to the network. The port starts in the *unauthorized* state. While in this state, the port disallows all ingress and egress traffic except for 802.1X protocol packets. When a client is successfully authenticated, the port transitions to the *authorized* state, allowing all traffic for the client to flow normally.

If a client that does not support 802.1X is connected to an unauthorized 802.1X port, the switch requests the client's identity. In this situation, the client does not respond to the request, the port remains in the unauthorized state, and the client is not granted access to the network.

In contrast, when an 802.1X-enabled client connects to a port that is not running the 802.1X protocol, the client initiates the authentication process by sending the EAPOL-start frame. When no response is received, the client sends the request for a fixed number of times. Because no response is received, the client begins sending frames as if the port is in the authorized state

If the client is successfully authenticated (receives an Accept frame from the authentication server), the port state changes to authorized, and all frames from the authenticated client are allowed through the port. If the authentication fails, the port remains in the unauthorized state, but authentication can be retried. If the authentication server cannot be reached, the switch can retransmit the request. If no response is received from the server after the specified number of attempts, authentication fails, and network access is not granted.

When a client logs off, it sends an EAPOL-logoff message, causing the switch port to transition to the unauthorized state.

If the link state of a port transitions from up to down, or if an EAPOL-logoff frame is received, the port returns to the unauthorized state.

#### 4.5.2.1 Authentication Configuration

This page allows you to configure how a user is authenticated when he logs into the switch via one of the management client interfaces. The Authentication Method Configuration screen in [Figure 4-5-2-3](#) appears.

### Authentication Method Configuration

Client	Methods		
console	local ▼	no ▼	no ▼
telnet	local ▼	no ▼	no ▼
ssh	local ▼	no ▼	no ▼
http	local ▼	no ▼	no ▼

### Command Authorization Method Configuration

Client	Method	Cmd Lvl	Cfg Cmd
console	no ▼	0	<input type="checkbox"/>
telnet	no ▼	0	<input type="checkbox"/>
ssh	no ▼	0	<input type="checkbox"/>

### Accounting Method Configuration

Client	Method	Cmd Lvl	Exec
console	no ▼		<input type="checkbox"/>
telnet	no ▼		<input type="checkbox"/>
ssh	no ▼		<input type="checkbox"/>

Figure 4-5-2-3: Authentication Method Configuration Page Screenshot

The page includes the following fields:

### Authentication Method Configuration

The authentication section allows you to configure how a user is authenticated when he logs into the switch via one of the management client interfaces.

The table has one row for each client type and a number of columns, which are:

Object	Description
<ul style="list-style-type: none"> <li>Client</li> </ul>	The management client for which the configuration below applies.
<ul style="list-style-type: none"> <li>Methods</li> </ul>	Method can be set to one of the following values: <ul style="list-style-type: none"> <li>no: Authentication is disabled and login is not possible.</li> <li>local: Use the local user database on the switch for authentication.</li> <li>radius: Use remote <a href="#">RADIUS</a> server(s) for authentication.</li> </ul>

	<ul style="list-style-type: none"> <li>• tacacs: Use remote <a href="#">TACACS+</a> server(s) for authentication..</li> </ul>
--	---

## Command Authorization Method Configuration

The command authorization section allows you to limit the CLI commands available to a user.

The table has one row for each client type and a number of columns, which are:

Object	Description
• Client	The management client for which the configuration below applies.
• Methods	Method can be set to one of the following values: <ul style="list-style-type: none"> <li>• no: Command authorization is disabled. User is granted access to CLI commands according to his privilege level.</li> <li>• tacacs: Use remote <a href="#">TACACS+</a> server(s) for command authorization. If all remote servers are offline, the user is granted access to CLI commands according to his privilege level</li> </ul>
• Cmd Lvl	Authorize all commands with a privilege level higher than or equal to this level. Valid values are in the range 0 to 15.
• Cfg Cmd	Also authorize configuration commands

## Accounting Method Configuration

The accounting section allows you to configure command and exec (login) accounting.

The table has one row for each client type and a number of columns, which are:

Object	Description
• Client	The management client for which the configuration below applies.
• Methods	Method can be set to one of the following values: <ul style="list-style-type: none"> <li>• no: Accounting is disabled.</li> <li>• tacacs: Use remote <a href="#">TACACS+</a> server(s) for accounting.</li> </ul>
• Cmd Lvl	Enable accounting of all commands with a privilege level higher than or equal to this level. Valid values are in the range 0 to 15. Leave the field empty to disable command

	accounting.
• Exec	Enable exec (login) accounting.

**Buttons**

: Click to apply changes

: Click to undo any changes made locally and revert to previously saved values.

**4.5.2.2 RADIUS**

This page allows you to configure the RADIUS Servers. The RADIUS Configuration screen in [Figure 4-5-2-4](#) appears.

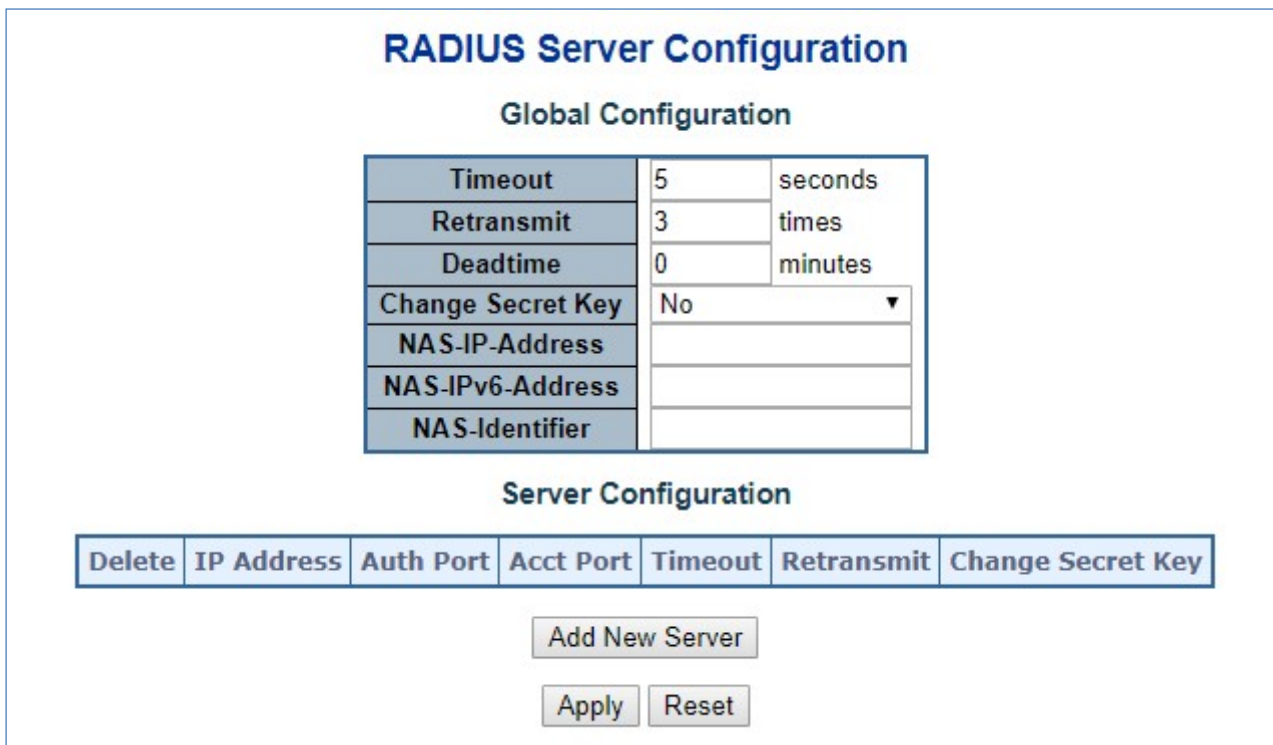

**Figure 4-5-2-4:** RADIUS Server Configuration Page Screenshot

The page includes the following fields:

**Global Configuration**

These setting are common for all of the RADIUS Servers.

Object	Description
• Timeout	Timeout is the number of seconds, in the range 1 to 1000, to wait for a reply from a RADIUS server before retransmitting the request.

<ul style="list-style-type: none"> <li>• <b>Retransmit</b></li> </ul>	Retransmit is the number of times, in the range from 1 to 1000; a RADIUS request is retransmitted to a server that is not responding. If the server has not responded after the last retransmit, it is considered to be dead.
<ul style="list-style-type: none"> <li>• <b>Dead Time</b></li> </ul>	<p>The Dead Time, which can be set to a number between 0 and 3600 seconds, is the period during which the switch will not send new requests to a server that has failed to respond to a previous request. This will stop the switch from continually trying to contact a server that it has already determined as dead.</p> <p>Setting the Dead Time to a value greater than 0 (zero) will enable this feature, but only if more than one server has been configured.</p>
<ul style="list-style-type: none"> <li>• <b>Key</b></li> </ul>	The secret key - up to 63 characters long - shared between the RADIUS server and the switch.
<ul style="list-style-type: none"> <li>• <b>NAS-IP-Address</b></li> </ul>	The IPv4 address to be used as attribute 4 in RADIUS Access-Request packets. If this field is left blank, the IP address of the outgoing interface is used.
<ul style="list-style-type: none"> <li>• <b>NAS-IPv6-Address</b></li> </ul>	The IPv6 address to be used as attribute 95 in RADIUS Access-Request packets. If this field is left blank, the IP address of the outgoing interface is used.
<ul style="list-style-type: none"> <li>• <b>NAS-Identifier</b></li> </ul>	The identifier - up to 253 characters long - to be used as attribute 32 in RADIUS Access-Request packets. If this field is left blank, the NAS-Identifier is not included in the packet.

### Server Configuration

The table has one row for each RADIUS Server and a number of columns, which are:

Object	Description
<ul style="list-style-type: none"> <li>• <b>Delete</b></li> </ul>	To delete a RADIUS server entry, check this box. The entry will be deleted during the next Save.
<ul style="list-style-type: none"> <li>• <b>Hostname</b></li> </ul>	The IP address or hostname of the RADIUS server.
<ul style="list-style-type: none"> <li>• <b>Auth Port</b></li> </ul>	The UDP port to use on the RADIUS server for authentication.
<ul style="list-style-type: none"> <li>• <b>Acct Port</b></li> </ul>	The UDP port to use on the RADIUS server for accounting.
<ul style="list-style-type: none"> <li>• <b>Timeout</b></li> </ul>	This optional setting overrides the global timeout value. Leaving it blank will use the global timeout value.
<ul style="list-style-type: none"> <li>• <b>Retransmit</b></li> </ul>	This optional setting overrides the global retransmit value. Leaving it blank will use the global retransmit value.
<ul style="list-style-type: none"> <li>• <b>Key</b></li> </ul>	This optional setting overrides the global key. Leaving it blank will use the global key.



**Buttons**

**Add New Server**: Click to add a new RADIUS server. An empty row is added to the table, and the RADIUS server can be configured as needed. Up to 5 servers are supported.

**Delete**: Click to undo the addition of the new server.

**Apply**: Click to apply changes

**Reset**: Click to undo any changes made locally and revert to previously saved values.

**4.5.2.3 TACACS+**

This page allows you to configure the TACACS+ Servers. The TACACS+ Configuration screen in [Figure 4-5-2-5](#) appears.

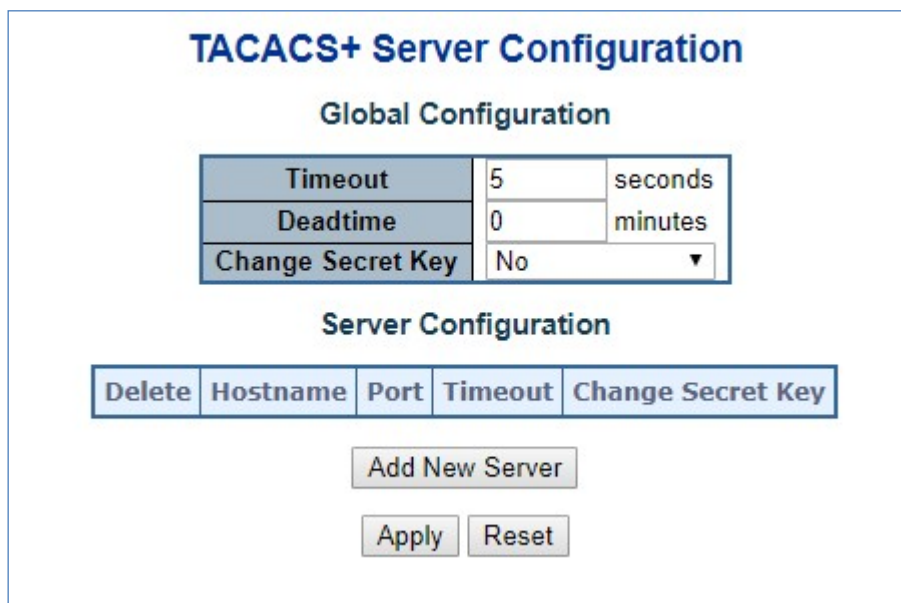

**Figure 4-5-2-5: TACACS+ Server Configuration Page Screenshot**

The page includes the following fields:

**Global Configuration**

These settings are common for all of the TACACS+ Servers.

Object	Description
<ul style="list-style-type: none"> <li><b>Timeout</b></li> </ul>	Timeout is the number of seconds, in the range 1 to 1000, to wait for a reply from a TACACS+ server before it is considered to be dead.
<ul style="list-style-type: none"> <li><b>Dead Time</b></li> </ul>	The Dead Time, which can be set to a number between 0 to 1440 minutes, is the period during which the switch will not send new requests to a server that has

	<p>failed to respond to a previous request. This will stop the switch from continually trying to contact a server that it has already determined as dead.</p> <p>Setting the Dead Time to a value greater than 0 (zero) will enable this feature, but only if more than one server has been configured.</p>
<ul style="list-style-type: none"> <li>• <b>Key</b></li> </ul>	<p>Specify to change the secret key or not. When "Yes" is selected for the option, you can change the secret key - up to 63 characters long - shared between the TACACS+ server and the switch.</p>

### Server Configuration

The table has one row for each TACACS+ server and a number of columns, which are:

Object	Description
<ul style="list-style-type: none"> <li>• <b>Delete</b></li> </ul>	To delete a TACACS+ server entry, check this box. The entry will be deleted during the next Save.
<ul style="list-style-type: none"> <li>• <b>Hostname</b></li> </ul>	The IP address or hostname of the TACACS+ server.
<ul style="list-style-type: none"> <li>• <b>Port</b></li> </ul>	The TCP port to use on the TACACS+ server for authentication.
<ul style="list-style-type: none"> <li>• <b>Timeout</b></li> </ul>	This optional setting overrides the global timeout value. Leaving it blank will use the global timeout value.
<ul style="list-style-type: none"> <li>• <b>Key</b></li> </ul>	This optional setting overrides the global key. Leaving it blank will use the global key.

### Buttons

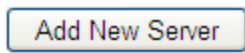
: Click to add a new TACACS+ server. An empty row is added to the table, and the TACACS+ server can be configured as needed. Up to 5 servers are supported.

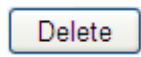
: Click to undo the addition of the new server.

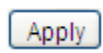
: Click to apply changes

: Click to undo any changes made locally and revert to previously saved values.

### 4.5.2.4 RADIUS Overview

This page provides an overview of the status of the RADIUS servers configurable on the authentication configuration page. The RADIUS Authentication/Accounting Server Overview screen in [Figure 4-5-2-6](#) appears.

RADIUS Server Status Overview					
#	IP Address	Authentication Port	Authentication Status	Accounting Port	Accounting Status
1			Disabled		Disabled
2			Disabled		Disabled
3			Disabled		Disabled
4			Disabled		Disabled
5			Disabled		Disabled

Auto-refresh

Figure 4-5-2-6: RADIUS Authentication/Accounting Server Overview Page Screenshot

The page includes the following fields:

**RADIUS Authentication Server Status Overview**

Object	Description
• #	The RADIUS server number. Click to navigate to detailed statistics for this server.
• IP Address	The IP address and UDP port number (in <IP Address>:<UDP Port> notation) of this server.
• Authentication Port	UDP port number for authentication.
• Authentication Status	The current status of the server. This field takes one of the following values: <b>Disabled</b> : The server is disabled. <b>Not Ready</b> : The server is enabled, but IP communication is not yet up and running. <b>Ready</b> : The server is enabled, IP communication is up and running, and the RADIUS module is ready to accept access attempts. <b>Dead (X seconds left)</b> : Access attempts were made to this server, but it did not reply within the configured timeout. The server has temporarily been disabled, but will get re-enabled when the dead-time expires. The number of seconds left before this occurs is displayed in parentheses. This state is only reachable when more than one server is enabled.
• Accounting Port	UDP port number for accounting
• Accounting Status	The current status of the server. This field takes one of the following values: <b>Disabled</b> : The server is disabled. <b>Not Ready</b> : The server is enabled, but IP communication is not yet up and running. <b>Ready</b> : The server is enabled, IP communication is up and running, and the RADIUS module is ready to accept access attempts. <b>Dead (X seconds left)</b> : Access attempts were made to this server, but it did not reply within the configured timeout. The server has temporarily been disabled, but will get re-enabled when the dead-time expires. The number of seconds left before this occurs is

---

---

	displayed in parentheses. This state is only reachable when more than one server is enabled.
--	--

---

---

**Buttons**

Auto-refresh  Check this box to refresh the page automatically. Automatic refresh occurs every 3 seconds.

: Click to refresh the page immediately.

### 4.5.2.5 RADIUS Details

This page provides detailed statistics for a particular RADIUS server. The RADIUS Authentication/Accounting for Server Overview screen in [Figure 4-5-2-7](#) appears.

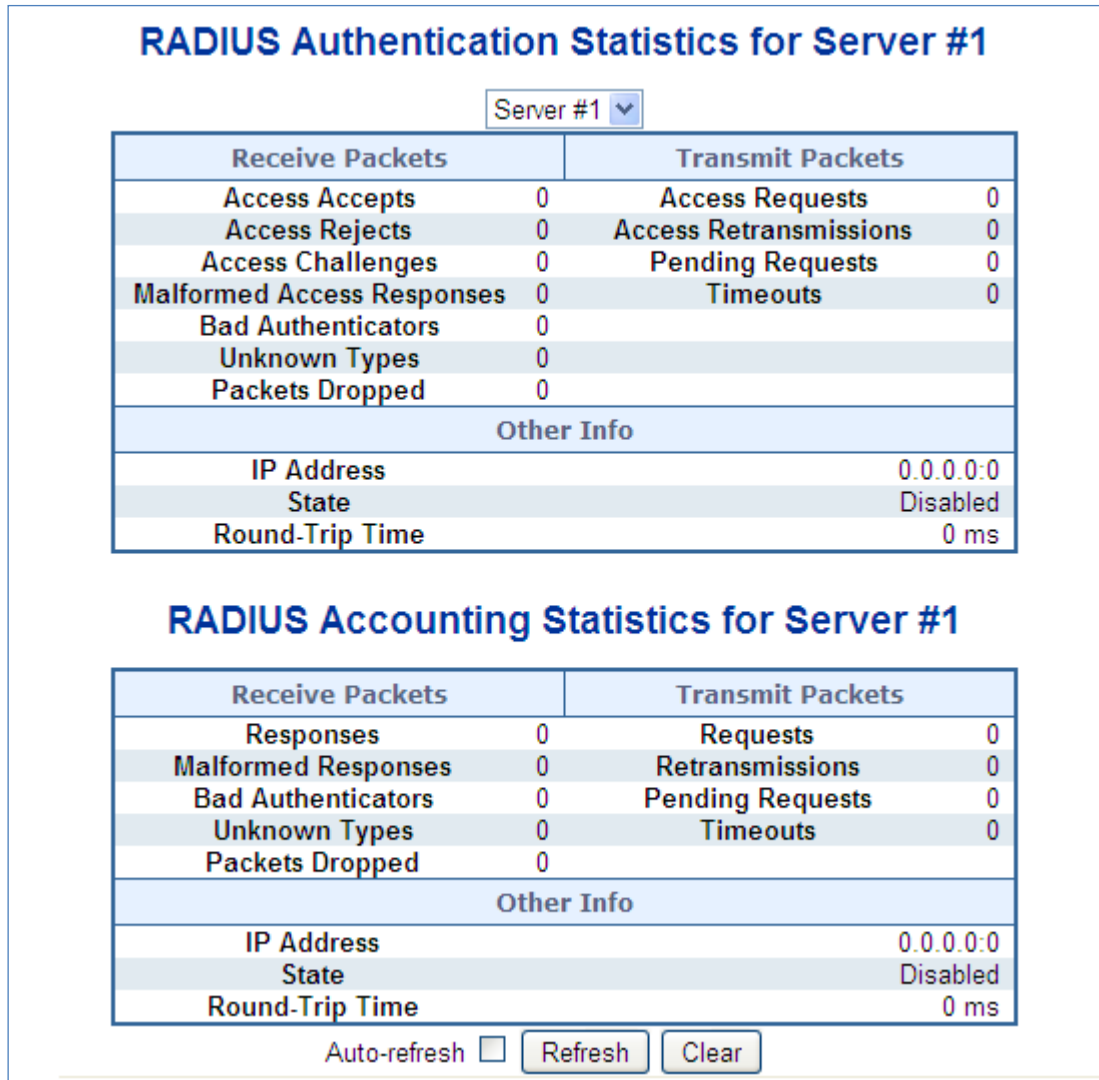

Figure 4-5-2-7: RADIUS Authentication/Accounting for Server Overview Screenshot

The page includes the following fields:

#### RADIUS Authentication Statistics

The statistics map closely to those specified in RFC4668 - RADIUS Authentication Client MIB. Use the server select box to switch between the backend servers to show details for.

Object	Description								
<ul style="list-style-type: none"> <li>Packet Counters</li> </ul>	RADIUS authentication server packet counter. There are seven receive and four transmit counters.								
	<table border="1"> <thead> <tr> <th>Direction</th> <th>Name</th> <th>RFC4668 Name</th> <th>Description</th> </tr> </thead> <tbody> <tr> <td>Rx</td> <td>Access</td> <td>radiusAuthClientExtA</td> <td>The number of RADIUS</td> </tr> </tbody> </table>	Direction	Name	RFC4668 Name	Description	Rx	Access	radiusAuthClientExtA	The number of RADIUS
Direction	Name	RFC4668 Name	Description						
Rx	Access	radiusAuthClientExtA	The number of RADIUS						

	<b>Accepts</b>	ccessAccepts	Access-Accept packets (valid or invalid) received from the server.
Rx	<b>Access Rejects</b>	radiusAuthClientExtAccessRejects	The number of RADIUS Access-Reject packets (valid or invalid) received from the server.
Rx	<b>Access Challenges</b>	radiusAuthClientExtAccessChallenges	The number of RADIUS Access-Challenge packets (valid or invalid) received from the server.
Rx	<b>Malformed Access Responses</b>	radiusAuthClientExtMalformedAccessResponses	The number of malformed RADIUS Access-Response packets received from the server. Malformed packets include packets with an invalid length. Bad authenticators or Message Authenticator attributes or unknown types are not included as malformed access responses.
Rx	<b>Bad Authenticators</b>	radiusAuthClientExtBadAuthenticators	The number of RADIUS Access-Response packets containing invalid authenticators or Message Authenticator attributes received from the server.
Rx	<b>Unknown Types</b>	radiusAuthClientExtUnknownTypes	The number of RADIUS packets that were received from the server on the authentication port and dropped for some other reason.
Rx	<b>Packets Dropped</b>	radiusAuthClientExtPacketsDropped	The number of RADIUS packets that were received from the server on the authentication port and

			dropped for some other reason.						
Tx	<b>Access Requests</b>	radiusAuthClientExtAccessRequests	The number of RADIUS Access-Request packets sent to the server. This does not include retransmissions.						
Tx	<b>Access Retransmissions</b>	radiusAuthClientExtAccessRetransmissions	The number of RADIUS Access-Request packets retransmitted to the RADIUS authentication server.						
Tx	<b>Pending Requests</b>	radiusAuthClientExtPendingRequests	The number of RADIUS Access-Request packets destined for the server that have not yet timed out or received a response. This variable is incremented when an Access-Request is sent and decremented due to receipt of an Access-Accept, Access-Reject, Access-Challenge, timeout, or retransmission.						
Tx	<b>Timeouts</b>	radiusAuthClientExtTimeouts	The number of authentication timeouts to the server. After a timeout, the client may retry to the same server, send to a different server, or give up. A retry to the same server is counted as a retransmit as well as a timeout. A send to a different server is counted as a Request as well as a timeout.						
<ul style="list-style-type: none"> <li><b>Other Info</b></li> </ul> <p>This section contains information about the state of the server and the latest round-trip time.</p> <table border="1"> <thead> <tr> <th>Name</th> <th>RFC4668 Name</th> <th>Description</th> </tr> </thead> <tbody> <tr> <td>IP Address</td> <td>-</td> <td>IP address and UDP port for the authentication server in question.</td> </tr> </tbody> </table>				Name	RFC4668 Name	Description	IP Address	-	IP address and UDP port for the authentication server in question.
Name	RFC4668 Name	Description							
IP Address	-	IP address and UDP port for the authentication server in question.							

	<b>State</b>	-	<p>Shows the state of the server. It takes one of the following values:</p> <ul style="list-style-type: none"> <li>■ <b>Disabled</b>: The selected server is disabled.</li> <li>■ <b>Not Ready</b>: The server is enabled, but IP communication is not yet up and running.</li> <li>■ <b>Ready</b>: The server is enabled, IP communication is up and running, and the RADIUS module is ready to accept access attempts.</li> <li>■ <b>Dead (X seconds left)</b>: Access attempts were made to this server, but it did not reply within the configured timeout. The server has temporarily been disabled, but will get re-enabled when the dead-time expires. The number of seconds left before this occurs is displayed in parentheses. This state is only reachable when more than one server is enabled.</li> </ul>
	<b>Round-Trip Time</b>	radiusAuthClient ExtRoundTripTime	<p>The time interval (measured in milliseconds) between the most recent Access-Reply/Access-Challenge and the Access-Request that matched it from the RADIUS authentication server. The granularity of this measurement is 100 ms. A value of 0 ms indicates that there hasn't been round-trip communication with the server yet.</p>

### RADIUS Accounting Statistics

The statistics map closely to those specified in RFC4670 - RADIUS Accounting Client MIB. Use the server select box to switch between the backend servers to show details for.

Object	Description			
<ul style="list-style-type: none"> <li>• <b>Packet Counters</b></li> </ul>	RADIUS accounting server packet counter. There are five receive and four transmit counters.			
	Direction	Name	RFC4670 Name	Description
	Rx	<b>Responses</b>	radiusAccClientExt Responses	The number of RADIUS packets (valid or invalid) received from the server.
Rx	<b>Malformed Responses</b>	radiusAccClientExt MalformedResponses	The number of malformed RADIUS packets received from the server. Malformed	



		es	packets include packets with an invalid length. Bad authenticators or unknown types are not included as malformed access responses.
Rx	<b>Bad Authenticators</b>	radiusAcctClientExt BadAuthenticators	The number of RADIUS packets containing invalid authenticators received from the server.
Rx	<b>Unknown Types</b>	radiusAccClientExt UnknownTypes	The number of RADIUS packets of unknown types that were received from the server on the accounting port.
Rx	<b>Packets Dropped</b>	radiusAccClientExt PacketsDropped	The number of RADIUS packets that were received from the server on the accounting port and dropped for some other reason.
Tx	<b>Requests</b>	radiusAccClientExt Requests	The number of RADIUS packets sent to the server. This does not include retransmissions.
Tx	<b>Retransmissions</b>	radiusAccClientExt Retransmissions	The number of RADIUS packets retransmitted to the RADIUS accounting server.
Tx	<b>Pending Requests</b>	radiusAccClientExt PendingRequests	The number of RADIUS packets destined for the server that have not yet timed out or received a response. This variable is incremented when a Request is sent and decremented due to receipt of a Response, timeout, or retransmission.
Tx	<b>Timeouts</b>	radiusAccClientExt Timeouts	The number of accounting timeouts to the server. After a timeout, the client may retry to

the same server, send to a different server, or give up. A retry to the same server is counted as a retransmit as well as a timeout. A send to a different server is counted as a Request as well as a timeout.

• Other Info

This section contains information about the state of the server and the latest round-trip time.

Name	RFC4670 Name	Description
IP Address	-	IP address and UDP port for the accounting server in question.
State	-	Shows the state of the server. It takes one of the following values: <ul style="list-style-type: none"> <li>■ <b>Disabled</b>: The selected server is disabled.</li> <li>■ <b>Not Ready</b>: The server is enabled, but IP communication is not yet up and running.</li> <li>■ <b>Ready</b>: The server is enabled, IP communication is up and running, and the RADIUS module is ready to accept accounting attempts.</li> <li>■ <b>Dead (X seconds left)</b>: Accounting attempts were made to this server, but it did not reply within the configured timeout. The server has temporarily been disabled, but will get re-enabled when the dead-time expires. The number of seconds left before this occurs is displayed in parentheses. This state is only reachable when more than one server is enabled.</li> </ul>
Round-Trip Time	radiusAccClientExtRoundTripTime	<ul style="list-style-type: none"> <li>■ The time interval (measured in milliseconds) between the most recent Response and the Request that matched it from the RADIUS accounting server. The granularity of this measurement is 100 ms. A value of 0 ms indicates that there hasn't been round-trip communication with the server yet.</li> </ul>

## Buttons

Auto-refresh  Check this box to refresh the page automatically. Automatic refresh occurs every 3 seconds.

: Click to refresh the page immediately.

: Clears the counters for the selected server. The "Pending Requests" counter will not be cleared by this operation.

### 4.5.3 Port Authentication

#### 4.5.3.1 Network Access Server Configuration

This page allows you to configure the IEEE 802.1X and MAC-based authentication system and port settings.

The IEEE 802.1X standard defines a port-based access control procedure that prevents unauthorized access to a network by requiring users to first submit credentials for authentication. One or more central servers, the backend servers, determine whether the user is allowed access to the network. These backend (RADIUS) servers are configured on the "Configuration→Security→AAA" Page. The IEEE802.1X standard defines port-based operation, but non-standard variants overcome security limitations as shall be explored below.

MAC-based authentication allows for authentication of more than one user on the same port, and doesn't require the user to have special 802.1X supplicant software installed on his system. The switch uses the user's MAC address to authenticate against the backend server. Intruders can create counterfeit MAC addresses, which makes MAC-based authentication less secure than 802.1X authentication. The NAS configuration consists of two sections, a system- and a port-wide. The Network Access Server Configuration screen in [Figure 4-5-3-1](#) appears.

### Network Access Server Configuration

#### System Configuration

Mode	Disabled <span style="float: right;">▼</span>
Reauthentication Enabled	<input type="checkbox"/>
Reauthentication Period	3600 seconds
EAPOL Timeout	30 seconds
Aging Period	300 seconds
Hold Time	10 seconds
RADIUS-Assigned QoS Enabled	<input type="checkbox"/>
RADIUS-Assigned VLAN Enabled	<input type="checkbox"/>
Guest VLAN Enabled	<input type="checkbox"/>
Guest VLAN ID	1
Max. Reauth. Count	2
Allow Guest VLAN if EAPOL Seen	<input type="checkbox"/>

#### Port Configuration

Port	Admin State	RADIUS-Assigned QoS Enabled	RADIUS-Assigned VLAN Enabled	Guest VLAN Enabled	Port State	Restart
*	<All> ▼	<input type="checkbox"/>	<input type="checkbox"/>	<input type="checkbox"/>		
1	Force Authorized ▼	<input type="checkbox"/>	<input type="checkbox"/>	<input type="checkbox"/>	Globally Disabled	Reauthenticate Reinitialize
2	Force Authorized ▼	<input type="checkbox"/>	<input type="checkbox"/>	<input type="checkbox"/>	Globally Disabled	Reauthenticate Reinitialize
3	Force Authorized ▼	<input type="checkbox"/>	<input type="checkbox"/>	<input type="checkbox"/>	Globally Disabled	Reauthenticate Reinitialize
4	Force Authorized ▼	<input type="checkbox"/>	<input type="checkbox"/>	<input type="checkbox"/>	Globally Disabled	Reauthenticate Reinitialize
5	Force Authorized ▼	<input type="checkbox"/>	<input type="checkbox"/>	<input type="checkbox"/>	Globally Disabled	Reauthenticate Reinitialize
6	Force Authorized ▼	<input type="checkbox"/>	<input type="checkbox"/>	<input type="checkbox"/>	Globally Disabled	Reauthenticate Reinitialize
7		<input type="checkbox"/>	<input type="checkbox"/>	<input type="checkbox"/>	Globally Disabled	Reauthenticate Reinitialize

**Figure 4-5-3-1:** Network Access Server Configuration Page Screenshot

The page includes the following fields:

System Configuration

Object	Description
<ul style="list-style-type: none"> <li>• <b>Mode</b></li> </ul>	<p>Indicates if NAS is globally enabled or disabled on the switch. If globally disabled, all ports are allowed forwarding of frames.</p>
<ul style="list-style-type: none"> <li>• <b>Reauthentication Enabled</b></li> </ul>	<p>If checked, successfully authenticated supplicants/clients are reauthenticated after the interval specified by the Reauthentication Period. Reauthentication for 802.1X-enabled ports can be used to detect if a new device is plugged into a switch port or if a supplicant is no longer attached.</p> <p>For MAC-based ports, reauthentication is only useful if the RADIUS server configuration has changed. It does not involve communication between the switch and the client, and therefore doesn't imply that a client is still present on a port.</p>
<ul style="list-style-type: none"> <li>• <b>Reauthentication Period</b></li> </ul>	<p>Determines the period, in seconds, after which a connected client must be reauthenticated. This is only active if the Reauthentication Enabled checkbox is checked. Valid values are in the range 1 to 3600 seconds.</p>
<ul style="list-style-type: none"> <li>• <b>EAPOL Timeout</b></li> </ul>	<p>Determines the time for retransmission of Request Identity EAPOL frames. Valid values are in the range 1 to 65535 seconds. This has no effect for MAC-based ports.</p>
<ul style="list-style-type: none"> <li>• <b>Aging Period</b></li> </ul>	<p>This setting applies to the following modes, i.e. modes using the Port Security functionality to secure MAC addresses:</p> <ul style="list-style-type: none"> <li>■ <b>Single 802.1X</b></li> <li>■ <b>Multi 802.1X</b></li> <li>■ <b>MAC-Based Auth.</b></li> </ul> <p>When the NAS module uses the Port Security module to secure MAC addresses, the Port Security module needs to check for activity on the MAC address in question at regular intervals and free resources if no activity is seen within a given period of time. This parameter controls exactly this period and can be set to a number between 10 and 1000000 seconds.</p> <p>If reauthentication is enabled and the port is in a 802.1X-based mode, this is not so critical, since supplicants that are no longer attached to the port will get removed upon the next reauthentication, which will fail. But if reauthentication is not enabled, the only way to free resources is by aging the entries.</p> <p>For ports in MAC-based Auth. mode, reauthentication doesn't cause direct communication between the switch and the client, so this will not detect whether the client is still attached or not, and the only way to free any resources is to age the entry.</p>

<ul style="list-style-type: none"> <li>• <b>Hold Time</b></li> </ul>	<p>This setting applies to the following modes, i.e. modes using the Port Security functionality to secure MAC addresses:</p> <ul style="list-style-type: none"> <li>■ <b>Single 802.1X</b></li> <li>■ <b>Multi 802.1X</b></li> <li>■ <b>MAC-Based Auth.</b></li> </ul> <p>If a client is denied access, either because the RADIUS server denies the client access or because the RADIUS server request times out (according to the timeout specified on the "Configuration→Security→AAA" page), the client is put on hold in the Unauthorized state. The hold timer does not count during an on-going authentication.</p> <p>In MAC-based Auth. mode, the switch will ignore new frames coming from the client during the hold time.</p> <p>The Hold Time can be set to a number between 10 and 1000000 seconds.</p>
<ul style="list-style-type: none"> <li>• <b>RADIUS-Assigned QoS Enabled</b></li> </ul>	<p>RADIUS-assigned QoS provides a means to centrally control the traffic class to which traffic coming from a successfully authenticated supplicant is assigned on the switch. The RADIUS server must be configured to transmit special RADIUS attributes to take advantage of this feature.</p> <p>The "RADIUS-Assigned QoS Enabled" checkbox provides a quick way to globally enable/disable RADIUS-server assigned QoS Class functionality. When checked, the individual ports' ditto setting determines whether RADIUS-assigned QoS Class is enabled for that port. When unchecked, RADIUS-server assigned QoS Class is disabled for all ports.</p>
<ul style="list-style-type: none"> <li>• <b>RADIUS-Assigned VLAN Enabled</b></li> </ul>	<p>RADIUS-assigned VLAN provides a means to centrally control the VLAN on which a successfully authenticated supplicant is placed on the switch. Incoming traffic will be classified to and switched on the RADIUS-assigned VLAN. The RADIUS server must be configured to transmit special RADIUS attributes to take advantage of this feature.</p> <p>The "RADIUS-Assigned VLAN Enabled" checkbox provides a quick way to globally enable/disable RADIUS-server assigned VLAN functionality. When checked, the individual ports' ditto setting determines whether RADIUS-assigned VLAN is enabled for that port. When unchecked, RADIUS-server assigned VLAN is disabled for all ports.</p>
<ul style="list-style-type: none"> <li>• <b>Guest VLAN Enabled</b></li> </ul>	<p>A Guest VLAN is a special VLAN - typically with limited network access - on which 802.1X-unaware clients are placed after a network administrator-defined timeout. The switch follows a set of rules for entering and leaving the Guest VLAN as listed below.</p>

	<p>The "Guest VLAN Enabled" checkbox provides a quick way to globally enable/disable Guest VLAN functionality. When checked, the individual ports' ditto setting determines whether the port can be moved into Guest VLAN. When unchecked, the ability to move to the Guest VLAN is disabled for all ports.</p>
<ul style="list-style-type: none"> <li>• <b>Guest VLAN ID</b></li> </ul>	<p>This is the value that a port's Port VLAN ID is set to if a port is moved into the Guest VLAN. It is only changeable if the Guest VLAN option is globally enabled.</p> <p>Valid values are in the range [1; 4095].</p>
<ul style="list-style-type: none"> <li>• <b>Max. Reauth. Count</b></li> </ul>	<p>The number of times that the switch transmits an EAPOL Request Identity frame without response before considering entering the Guest VLAN is adjusted with this setting. The value can only be changed if the Guest VLAN option is globally enabled.</p> <p>Valid values are in the range [1; 255].</p>
<ul style="list-style-type: none"> <li>• <b>Allow Guest VLAN if EAPOL Seen</b></li> </ul>	<p>The switch remembers if an EAPOL frame has been received on the port for the life-time of the port. Once the switch considers whether to enter the Guest VLAN, it will first check if this option is enabled or disabled. If disabled (unchecked; default), the switch will only enter the Guest VLAN if an EAPOL frame has not been received on the port for the life-time of the port. If enabled (checked), the switch will consider entering the Guest VLAN even if an EAPOL frame has been received on the port for the life-time of the port.</p> <p>The value can only be changed if the Guest VLAN option is globally enabled.</p>

### 4.5.3.2 Network Access Overview

This page provides an overview of the current NAS port states for the selected switch. The Network Access Overview screen in Figure 4-5-3-2 appears.

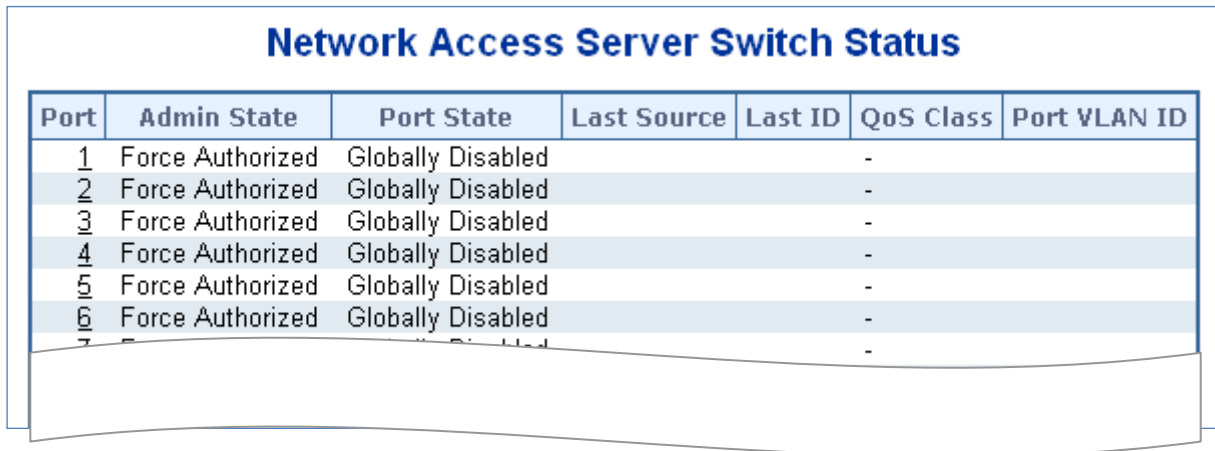

Port	Admin State	Port State	Last Source	Last ID	QoS Class	Port VLAN ID
1	Force Authorized	Globally Disabled			-	
2	Force Authorized	Globally Disabled			-	
3	Force Authorized	Globally Disabled			-	
4	Force Authorized	Globally Disabled			-	
5	Force Authorized	Globally Disabled			-	
6	Force Authorized	Globally Disabled			-	
7	Force Authorized	Globally Disabled			-	

Figure 4-5-3-2: Network Access Server Switch Status Page Screenshot

The page includes the following fields:

Object	Description
• <b>Port</b>	The switch port number. Click to navigate to detailed NAS statistics for this port.
• <b>Admin State</b>	The port's current administrative state. Refer to NAS Admin State for a description of possible values.
• <b>Port State</b>	The current state of the port. Refer to NAS Port State for a description of the individual states.
• <b>Last Source</b>	The source MAC address carried in the most recently received EAPOL frame for EAPOL-based authentication, and the most recently received frame from a new client for MAC-based authentication.
• <b>Last ID</b>	The user name (supplicant identity) carried in the most recently received Response Identity EAPOL frame for EAPOL-based authentication, and the source MAC address from the most recently received frame from a new client for MAC-based authentication.
• <b>QoS Class</b>	QoS Class assigned to the port by the RADIUS server if enabled.
• <b>Port VLAN ID</b>	The VLAN ID that NAS has put the port in. The field is blank, if the Port VLAN ID is not overridden by NAS. If the VLAN ID is assigned by the RADIUS server, "(RADIUS-assigned)" is appended to the VLAN ID. Read more about RADIUS-assigned VLANs here. If the port is moved to the Guest VLAN, "(Guest)" is appended to the VLAN ID. Read more about Guest VLANs here.

### Buttons



Auto-refresh  Check this box to refresh the page automatically. Automatic refresh occurs every 3 seconds.

: Click to refresh the page immediately.

### 4.5.3.3 Network Access Statistics

This page provides detailed NAS statistics for a specific switch port running EAPOL-based IEEE 802.1X authentication. For MAC-based ports, it shows selected backend server (RADIUS Authentication Server) statistics, only. Use the port select box to select which port details to be displayed. The Network Access Statistics screen in [Figure 4-5-3-3](#) appears.

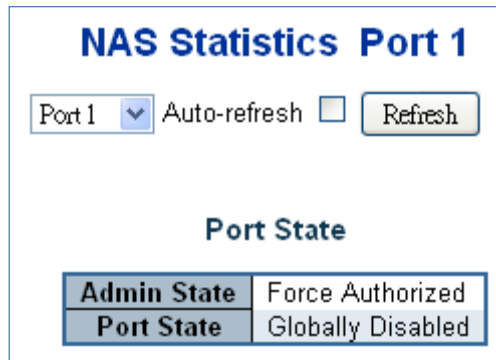

Figure 4-5-3-3: Network Access Statistics Page Screenshot

The page includes the following fields:

#### Port State

Object	Description
<ul style="list-style-type: none"> <li>• <b>Admin State</b></li> </ul>	The port's current administrative state. Refer to NAS Admin State for a description of possible values.
<ul style="list-style-type: none"> <li>• <b>Port State</b></li> </ul>	The current state of the port. Refer to NAS Port State for a description of the individual states.
<ul style="list-style-type: none"> <li>• <b>QoS Class</b></li> </ul>	The QoS class assigned by the RADIUS server. The field is blank if no QoS class is assigned.
<ul style="list-style-type: none"> <li>• <b>Port VLAN ID</b></li> </ul>	<p>The VLAN ID that NAS has put the port in. The field is blank, if the Port VLAN ID is not overridden by NAS.</p> <p>If the VLAN ID is assigned by the RADIUS server, "(RADIUS-assigned)" is appended to the VLAN ID. Read more about RADIUS-assigned VLANs here.</p> <p>If the port is moved to the Guest VLAN, "(Guest)" is appended to the VLAN ID. Read more about Guest VLANs here.</p>

Port Counters

Object	Description			
<ul style="list-style-type: none"> <li>• <b>EAPOL Counters</b></li> </ul>	<p>These supplicant frame counters are available for the following administrative states:</p> <ul style="list-style-type: none"> <li>■ <b>Force Authorized</b></li> <li>■ <b>Force Unauthorized</b></li> <li>■ <b>Port-based 802.1X</b></li> <li>■ <b>Single 802.1X</b></li> <li>■ <b>Multi 802.1X</b></li> </ul>			
	Direction	Name	IEEE Name	Description
	Rx	<b>Total</b>	dot1xAuthEapolFramesRx	The number of valid EAPOL frames of any type that have been received by the switch.
	Rx	<b>Response ID</b>	dot1xAuthEapolRespIdFramesRx	The number of valid EAPOL Response Identity frames that have been received by the switch.
	Rx	<b>Responses</b>	dot1xAuthEapolRespFramesRx	The number of valid EAPOL response frames (other than Response Identity frames) that have been received by the switch.
	Rx	<b>Start</b>	dot1xAuthEapolStartFramesRx	The number of EAPOL Start frames that have been received by the switch.
	Rx	<b>Logoff</b>	dot1xAuthEapolLogoffFramesRx	The number of valid EAPOL Logoff frames that have been received by the switch.
	Rx	<b>Invalid Type</b>	dot1xAuthInvalidEapolFramesRx	The number of EAPOL frames that have been received by the switch in which the frame type is not recognized.
Rx	<b>Invalid Length</b>	dot1xAuthEapLengthErrorFramesRx	The number of EAPOL frames that have been received by the switch in	

which the Packet Body Length field is invalid.

Tx	<b>Total</b>	dot1xAuthEapolFramesTx	The number of EAPOL frames of any type that have been transmitted by the switch.
Tx	<b>Request ID</b>	dot1xAuthEapolReqIdFramesTx	The number of EAPOL Request Identity frames that have been transmitted by the switch.
Tx	<b>Requests</b>	dot1xAuthEapolReqFramesTx	The number of valid EAPOL Request frames (other than Request Identity frames) that have been transmitted by the switch.

• **Backend Server Counters**

These backend (RADIUS) frame counters are available for the following administrative states:

- **Port-based 802.1X**
- **Single 802.1X**
- **Multi 802.1X**
- **MAC-based Auth.**

Direction	Name	IEEE Name	Description
Rx	<b>Access Challenges</b>	dot1xAuthBackendAccessChallenges	<p><b>802.1X-based:</b></p> <p>Counts the number of times that the switch receives the first request from the backend server following the first response from the supplicant. Indicates that the backend server has communication with the switch.</p> <p><b>MAC-based:</b></p> <p>Counts all Access Challenges received from the backend server for this port (left-most table) or client (right-most table).</p>

Rx	<b>Other Requests</b>	dot1xAuthBackendOther RequestsToSupplicant	<p><b>802.1X-based:</b> Counts the number of times that the switch sends an EAP Request packet following the first to the supplicant. Indicates that the backend server chose an EAP-method.</p> <p><b>MAC-based:</b> Not applicable.</p>
Rx	<b>Auth. Successes</b>	dot1xAuthBackendAuth Successes	<p><b>802.1X- and MAC-based:</b> Counts the number of times that the switch receives a success indication. Indicates that the supplicant/client has successfully authenticated to the backend server.</p>
Rx	<b>Auth. Failures</b>	dot1xAuthBackendAuth Fails	<p><b>802.1X- and MAC-based:</b> Counts the number of times that the switch receives a failure message. This indicates that the supplicant/client has not authenticated to the backend server.</p>
Tx	<b>Responses</b>	dot1xAuthBackendResponses	<p><b>802.1X-based:</b> Counts the number of times that the switch attempts to send a supplicant's first response packet to the backend server. Indicates the switch attempted communication with the backend server. Possible retransmissions are not counted.</p> <p><b>MAC-based:</b> Counts all the backend server packets sent from the switch towards the backend server for a given port (left-most</p>

	<p>table) or client (right-most table). Possible retransmissions are not counted.</p>															
<p>• <b>Last Supplicant/Client Info</b></p>	<p>Information about the last supplicant/client that attempted to authenticate. This information is available for the following administrative states:</p> <ul style="list-style-type: none"> <li>■ <b>Port-based 802.1X</b></li> <li>■ <b>Single 802.1X</b></li> <li>■ <b>Multi 802.1X</b></li> <li>■ <b>MAC-based Auth.</b></li> </ul> <table border="1" data-bbox="523 696 1493 1518"> <thead> <tr> <th data-bbox="523 696 676 745">Name</th> <th data-bbox="676 696 940 745">IEEE Name</th> <th data-bbox="940 696 1493 745">Description</th> </tr> </thead> <tbody> <tr> <td data-bbox="523 745 676 869"><b>MAC Address</b></td> <td data-bbox="676 745 940 869">dot1xAuthLastEapolFrameSource</td> <td data-bbox="940 745 1493 869">The MAC address of the last supplicant/client.</td> </tr> <tr> <td data-bbox="523 869 676 992"><b>VLAN ID</b></td> <td data-bbox="676 869 940 992">-</td> <td data-bbox="940 869 1493 992">The VLAN ID on which the last frame from the last supplicant/client was received.</td> </tr> <tr> <td data-bbox="523 992 676 1227"><b>Version</b></td> <td data-bbox="676 992 940 1227">dot1xAuthLastEapolFrameVersion</td> <td data-bbox="940 992 1493 1227"> <p><b>802.1X-based:</b> The protocol version number carried in the most recently received EAPOL frame.</p> <p><b>MAC-based:</b> Not applicable.</p> </td> </tr> <tr> <td data-bbox="523 1227 676 1518"><b>Identity</b></td> <td data-bbox="676 1227 940 1518">-</td> <td data-bbox="940 1227 1493 1518"> <p><b>802.1X-based:</b> The user name (supplicant identity) carried in the most recently received Response Identity EAPOL frame.</p> <p><b>MAC-based:</b> Not applicable.</p> </td> </tr> </tbody> </table>	Name	IEEE Name	Description	<b>MAC Address</b>	dot1xAuthLastEapolFrameSource	The MAC address of the last supplicant/client.	<b>VLAN ID</b>	-	The VLAN ID on which the last frame from the last supplicant/client was received.	<b>Version</b>	dot1xAuthLastEapolFrameVersion	<p><b>802.1X-based:</b> The protocol version number carried in the most recently received EAPOL frame.</p> <p><b>MAC-based:</b> Not applicable.</p>	<b>Identity</b>	-	<p><b>802.1X-based:</b> The user name (supplicant identity) carried in the most recently received Response Identity EAPOL frame.</p> <p><b>MAC-based:</b> Not applicable.</p>
Name	IEEE Name	Description														
<b>MAC Address</b>	dot1xAuthLastEapolFrameSource	The MAC address of the last supplicant/client.														
<b>VLAN ID</b>	-	The VLAN ID on which the last frame from the last supplicant/client was received.														
<b>Version</b>	dot1xAuthLastEapolFrameVersion	<p><b>802.1X-based:</b> The protocol version number carried in the most recently received EAPOL frame.</p> <p><b>MAC-based:</b> Not applicable.</p>														
<b>Identity</b>	-	<p><b>802.1X-based:</b> The user name (supplicant identity) carried in the most recently received Response Identity EAPOL frame.</p> <p><b>MAC-based:</b> Not applicable.</p>														

## 4.5.4 Port Security

### 4.5.4.1 Port Limit Control

This page allows you to configure the Port Security global and per-port settings.

Port Security allows for limiting the number of users on a given port. A user is identified by a MAC address and VLAN ID. If Port Security is enabled on a port, the limit specifies the maximum number of users on the port. If this number is exceeded, an action is taken depending on violation mode. The violation mode can be one of the four different described below.

The Port Security configuration consists of two sections, a global and a per-port.. The Port Limit Control Configuration screen in [Figure 4-5-4-1](#) appears.

### Port Security Configuration

#### Global Configuration

<b>Aging Enabled</b>	<input type="checkbox"/>
<b>Aging Period</b>	3600 seconds
<b>Hold Time</b>	300 seconds

#### Port Configuration

Port	Mode	Limit	Violation Mode	Violation Limit	State
*	<All> ▼	4	<All> ▼	4	
1	Disabled ▼	4	Protect ▼	4	Disabled
2	Disabled ▼	4	Protect ▼	4	Disabled
3	Disabled ▼	4	Protect ▼	4	Disabled
4	Disabled ▼	4	Protect ▼	4	Disabled
5	Disabled ▼	4	Protect ▼	4	Disabled
6	Disabled ▼	4	Protect ▼	4	Disabled
7	Disabled ▼	4	Protect ▼	4	Disabled
8	Disabled ▼	4	Protect ▼	4	Disabled

**Figure 4-5-4-1:** Port Limit Control Configuration Overview Page Screenshot

The page includes the following fields:

#### System Configuration

Object	Description
<ul style="list-style-type: none"> <li><b>Aging Enabled</b></li> </ul>	If checked, secured MAC addresses are subject to aging as discussed under <a href="#">Aging Period</a> .

<ul style="list-style-type: none"> <li>• <b>Aging Period</b></li> </ul>	<p>If Aging Enabled is checked, then the aging period is controlled with this input. If other modules are using the underlying port security for securing MAC addresses, they may have other requirements to the aging period. The underlying port security will use the shorter requested aging period of all modules that use the functionality.</p> <p>The Aging Period can be set to a number between 10 and 10,000,000 seconds. To understand why aging may be desired, consider the following scenario: Suppose an end-host is connected to a 3rd party switch or hub, which in turn is connected to a port on this switch on which Limit Control is enabled. The end-host will be allowed to forward if the limit is not exceeded. Now suppose that the end-host logs off or powers down. If it wasn't for aging, the end-host would still take up resources on this switch and will be allowed to forward. To overcome this situation, enable aging. With aging enabled, a timer is started once the end-host gets secured. When the timer expires, the switch starts looking for frames from the end-host, and if such frames are not seen within the next Aging Period, the end-host is assumed to be disconnected, and the corresponding resources are freed on the switch.</p>
<ul style="list-style-type: none"> <li>• <b>Hold Time</b></li> </ul>	<p>The hold time - measured in seconds - is used to determine how long a MAC address is held in the MAC table if it has been found to violate the limit. Valid range is between 10 and 10000000 seconds with a default of 300 seconds.</p> <p>The reason for holding a violating MAC address in the MAC table is primarily to ensure that the same MAC address doesn't give rise to continuous notifications (if notifications on violation count is enabled).</p>

### Port Configuration

The table has one row for each port and a number of columns, which are:

Object	Description
<ul style="list-style-type: none"> <li>• <b>Port</b></li> </ul>	The port number for which the configuration below applies.
<ul style="list-style-type: none"> <li>• <b>Mode</b></li> </ul>	Controls whether Limit Control is enabled on this port. Both this and the Global Mode must be set to Enabled for Limit Control to be in effect. Notice that other modules may still use the underlying port security features without enabling Limit Control on a given port.
<ul style="list-style-type: none"> <li>• <b>Limit</b></li> </ul>	The maximum number of MAC addresses that can be secured on this port. This number cannot exceed 1024. If the limit is exceeded, the corresponding action is taken.

	<p>The switch is "born" with a total number of MAC addresses from which all ports draw whenever a new MAC address is seen on a Port Security-enabled port. Since all ports draw from the same pool, it may happen that a configured maximum cannot be granted, if the remaining ports have already used all available MAC addresses.</p>
<ul style="list-style-type: none"> <li>• <b>Violation Mode</b></li> </ul>	<p>If Limit is reached, the switch can take one of the following actions:</p> <p><b>Protect:</b> Do not allow more than Limit MAC addresses on the port, but take no further action.</p> <p><b>Restrict:</b> If Limit is reached, subsequent MAC addresses on the port will be counted and marked as violating. Such MAC addresses are removed from the MAC table when the hold time expires. At most Violation Limit MAC addresses can be marked as violating at any given time.</p> <p><b>Shutdown:</b> If Limit is reached, one additional MAC address will cause the port to be shut down. This implies that all secured MAC addresses be removed from the port, and no new addresses be learned. There are three ways to re-open the port:</p> <ol style="list-style-type: none"> <li>1) In the "Configuration→Ports" page's "Configured" column, first disable the port, then restore the original mode.</li> <li>2) Make a Port Security configuration change on the port.</li> <li>3) Boot the switch.</li> </ol>
<ul style="list-style-type: none"> <li>• <b>Violation Limit</b></li> </ul>	<ul style="list-style-type: none"> <li>■ The maximum number of MAC addresses that can be marked as violating on this port. This number cannot exceed 1024. Default is 4. It is only used when Violation Mode is <b>Restrict</b>.</li> </ul>
<ul style="list-style-type: none"> <li>• <b>State</b></li> </ul>	<p>This column shows the current state of the port as seen from the Limit Control's point of view. The state takes one of four values:</p> <ul style="list-style-type: none"> <li>■ <b>Disabled:</b> Limit Control is either globally disabled or disabled on the port.</li> <li>■ <b>Ready:</b> The limit is not yet reached. This can be shown for all actions.</li> <li>■ <b>Limit Reached:</b> Indicates that the limit is reached on this port. This state can only be shown if Action is set to <b>None</b> or <b>Trap</b>.</li> </ul> <p><b>Shutdown:</b> Indicates that the port is shut down by the Limit Control module. This state can only be shown if Action is set to <b>Shutdown</b> or <b>Trap &amp; Shutdown</b>.</p>



**Apply** : Click to apply changes

**Reset** : Click to undo any changes made locally and revert to previously saved values.

**Refresh** : Click to refresh the page. Note that non-committed changes will be lost.

#### 4.5.4.2 Port Security Status

This page shows the Port Security status. Port Security is a module with no direct configuration. Configuration comes indirectly from other modules - the user modules. When a user module has enabled port security on a port, the port is set-up for software-based learning. In this mode, frames from unknown MAC addresses are passed on to the port security module, which in turn asks all user modules whether to allow this new MAC address to forward or block it. For a MAC address to be set in the forwarding state, all enabled user modules must unanimously agree on allowing the MAC address to forward. If only one chooses to block it, it will be blocked until that user module decides otherwise.

The status page is divided into two sections - one with a legend of user modules and one with the actual port status. The Port Security Status screen in [Figure 4-5-4-2](#) appears.

### Port Security Switch Status

#### User Module Legend

User Module Name	Abbr
Port Security (Admin)	P
802.1X	8
Voice VLAN	V

#### Port Status

Clear	Port	Users	Violation Mode	State	MAC Count		
					Current	Violating	Limit
<input type="button" value="Clear"/>	1	---	Disabled	Disabled	-	-	-
<input type="button" value="Clear"/>	2	---	Disabled	Disabled	-	-	-
<input type="button" value="Clear"/>	3	---	Disabled	Disabled	-	-	-
<input type="button" value="Clear"/>	4	---	Disabled	Disabled	-	-	-
<input type="button" value="Clear"/>	5	---	Disabled	Disabled	-	-	-
<input type="button" value="Clear"/>	6	---	Disabled	Disabled	-	-	-
<input type="button" value="Clear"/>	7	---	Disabled	Disabled	-	-	-
<input type="button" value="Clear"/>	8	---	Disabled	Disabled	-	-	-

Auto-refresh

Figure 4-5-4-2: Port Security Status Screen Page Screenshot



The page includes the following fields:

### User Module Legend

The legend shows all user modules that may request Port Security services.

Object	Description
<ul style="list-style-type: none"> <li>• <b>User Module Name</b></li> </ul>	The full name of a module that may request Port Security services.
<ul style="list-style-type: none"> <li>• <b>Abbr</b></li> </ul>	A one-letter abbreviation of the user module. This is used in the Users column in the port status table.

### Port Status

The table has one row for each port on the selected switch in the switch and a number of columns, which are:

Object	Description
<ul style="list-style-type: none"> <li>• <b>Clear</b></li> </ul>	Click to remove all MAC addresses on all VLANs on this port. The button is only clickable if number of secured MAC addresses is non-zero.
<ul style="list-style-type: none"> <li>• <b>Port</b></li> </ul>	The port number for which the status applies. Click the port number to see the status for this particular port.
<ul style="list-style-type: none"> <li>• <b>Users</b></li> </ul>	Each of the user modules has a column that shows whether that module has enabled Port Security or not. A '-' means that the corresponding user module is not enabled, whereas a letter indicates that the user module abbreviated by that letter has enabled port security.
<ul style="list-style-type: none"> <li>• <b>Violation Mode</b></li> </ul>	Shows the configured Violation Mode of the port. It can take one of four values: <b>Disabled:</b> Port Security is not administratively enabled on this port. <b>Protect:</b> Port Security is administratively enabled in Protect mode. <b>Restrict:</b> Port Security is administratively enabled in Restrict mode. <b>Shutdown:</b> Port Security is administratively enabled in Shutdown mode.
<ul style="list-style-type: none"> <li>• <b>State</b></li> </ul>	Shows the current state of the port. It can take one of four values: <ul style="list-style-type: none"> <li>■ <b>Disabled:</b> No user modules are currently using the Port Security service.</li> <li>■ <b>Ready:</b> The Port Security service is in use by at least one user module, and is awaiting frames from unknown MAC addresses to arrive.</li> <li>■ <b>Limit Reached:</b> The Port Security service is enabled by at least the Limit Control user module, and that module has indicated that the limit is reached and no more MAC addresses should be taken in.</li> <li>■ <b>Shutdown:</b> The Port Security service is enabled by at least the Limit Control user module, and that module has indicated that the limit is exceeded. No MAC addresses can be learned on the port until it is administratively re-opened on the Limit Control configuration web page.</li> </ul>

<ul style="list-style-type: none"> <li>• <b>MAC Count (Current, Limit)</b></li> </ul>	<p>The two columns indicate the number of currently learned MAC addresses (forwarding as well as blocked) and the maximum number of MAC addresses that can be learned on the port, respectively.</p> <p>If no user modules are enabled on the port, the Current column will show a dash (-).</p> <p>If the Limit Control user module is not enabled on the port, the Limit column will show a dash (-).</p>
---	---

**Buttons**

Auto-refresh  Check this box to refresh the page automatically. Automatic refresh occurs every 3 seconds.

: Click to refresh the page immediately.

**4.5.4.3 Port Security Detail**

This page shows the MAC addresses secured by the Port Security module. Port Security is a module with no direct configuration. Configuration comes indirectly from other modules - the user modules. When a user module has enabled port security on a port, the port is set-up for software-based learning. In this mode, frames from unknown MAC addresses are passed on to the port security module, which in turn asks all user modules whether to allow this new MAC address to forward or block it. For a MAC address to be set in the forwarding state, all enabled user modules must unanimously agree on allowing the MAC address to forward. If only one chooses to block it, it will be blocked until that user module decides otherwise. The Port Security Detail screen in [Figure 4-5-4-3](#) appears.

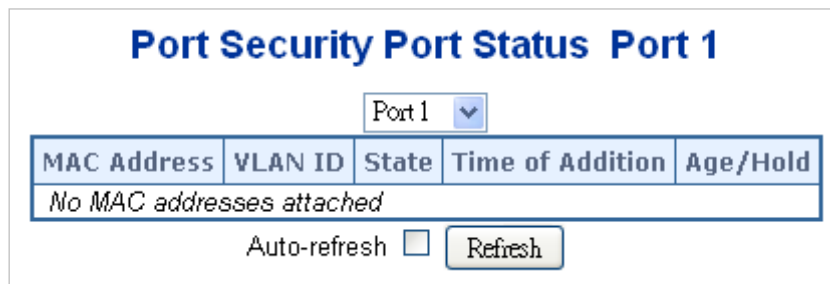

**Figure 4-5-4-3:** Port Security Detail Screen Page Screenshot

The page includes the following fields:

Object	Description
<ul style="list-style-type: none"> <li>• <b>MAC Address &amp; VLAN ID</b></li> </ul>	<p>The MAC address and VLAN ID that is seen on this port. If no MAC addresses are learned, a single row stating "No MAC addresses attached" is displayed.</p>
<ul style="list-style-type: none"> <li>• <b>State</b></li> </ul>	<p>Indicates whether the corresponding MAC address is blocked or forwarding. In the blocked state, it will not be allowed to transmit or receive traffic.</p>
<ul style="list-style-type: none"> <li>• <b>Time of Addition</b></li> </ul>	<p>Shows the date and time when this MAC address was first seen on the port.</p>

---

<ul style="list-style-type: none"><li>• <b>Age/Hold</b></li></ul>	<ul style="list-style-type: none"><li>● If at least one user module has decided to block this MAC address, it will stay in the blocked state until the hold time (measured in seconds) expires.</li><li>● If all user modules have decided to allow this MAC address to forward, and aging is enabled, the Port Security module will periodically check that this MAC address still forwards traffic.</li><li>● If the age period (measured in seconds) expires and no frames have been seen, the MAC address will be removed from the MAC table. Otherwise a new age period will begin.</li><li>● If aging is disabled or a user module has decided to hold the MAC address indefinitely, a dash (-) will be shown.</li></ul>
---	--

---

### 4.5.5 Access Control Lists

ACL is an acronym for Access Control List. It is the list table of ACEs, containing access control entries that specify individual users or groups permitted or denied to specific traffic objects, such as a process or a program.

Each accessible traffic object contains an identifier to its ACL. The privileges determine whether there are specific traffic object access rights.

ACL implementations can be quite complex, for example, when the ACEs are prioritized for the various situation. In networking, the ACL refers to a list of service ports or network services that are available on a host or server, each with a list of hosts or servers permitted or denied to use the service. ACL can generally be configured to control inbound traffic, and in this context, they are similar to firewalls.

**ACE** is an acronym for **Access Control Entry**. It describes access permission associated with a particular ACE ID.

There are three ACE frame types (**Ethernet Type**, **ARP**, and **IPv4**) and two ACE actions (**permit** and **deny**). The ACE also contains many detailed, different parameter options that are available for individual application.

#### 4.5.5.1 Access Control List Status

This page shows the ACL status by different ACL users. Each row describes the ACE that is defined. It is a conflict if a specific ACE is not applied to the hardware due to hardware limitations. The maximum number of ACEs is **512** on each switch. The Voice VLAN OUI Table screen in [Figure 4-5-5-1](#) appears.

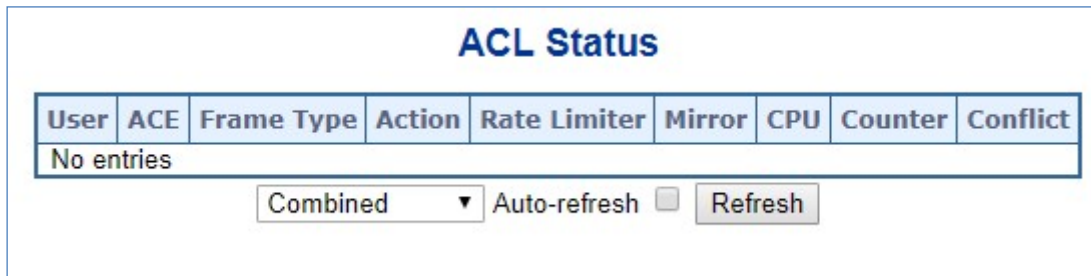

Figure 4-5-5-1: ACL Status Page Screenshot

The page includes the following fields:

Object	Description
• <b>User</b>	Indicates the ACL user.
• <b>ACE</b>	Indicates the ACE ID on local switch.
• <b>Frame Type</b>	Indicates the frame type of the ACE. Possible values are: <ul style="list-style-type: none"> <li>■ <b>Any</b>: The ACE will match any frame type.</li> <li>■ <b>EType</b>: The ACE will match Ethernet Type frames. Note that an Ethernet Type based ACE will not get matched by IP and ARP frames.</li> <li>■ <b>ARP</b>: The ACE will match ARP/RARP frames.</li> <li>■ <b>IPv4</b>: The ACE will match all IPv4 frames.</li> </ul>

	<ul style="list-style-type: none"> <li>■ <b>IPv4/ICMP</b>: The ACE will match IPv4 frames with ICMP protocol.</li> <li>■ <b>IPv4/UDP</b>: The ACE will match IPv4 frames with UDP protocol.</li> <li>■ <b>IPv4/TCP</b>: The ACE will match IPv4 frames with TCP protocol.</li> <li>■ <b>IPv4/Other</b>: The ACE will match IPv4 frames, which are not ICMP/UDP/TCP.</li> <li>■ <b>IPv6</b>: The ACE will match all IPv6 standard frames.</li> </ul>
• <b>Action</b>	<p>Indicates the forwarding action of the ACE.</p> <ul style="list-style-type: none"> <li>■ <b>Permit</b>: Frames matching the ACE may be forwarded and learned.</li> <li>■ <b>Deny</b>: Frames matching the ACE are dropped.</li> </ul>
• <b>Rate Limiter</b>	<p>Indicates the rate limiter number of the ACE. The allowed range is 1 to 16. When Disabled is displayed, the rate limiter operation is disabled.</p>
• <b>CPU</b>	<p>Forward packet that matched the specific ACE to CPU</p>
• <b>Counter</b>	<p>The counter indicates the number of times the ACE was hit by a frame.</p>
• <b>Conflict</b>	<p>Indicates the hardware status of the specific ACE. The specific ACE is not applied to the hardware due to hardware limitations.</p>

**Buttons**

Auto-refresh  Check this box to refresh the page automatically. Automatic refresh occurs every 3 seconds.

: Click to refresh the page.

### 4.5.5.2 Access Control List Configuration

This page shows the Access Control List (ACL), which is made up of the ACEs defined on this switch. Each row describes the ACE that is defined. The maximum number of ACEs is **512** on each switch.

Click on the lowest plus sign to add a new ACE to the list. The reserved ACEs used for internal protocol, cannot be edited or deleted, the order sequence cannot be changed and the priority is highest. The Access Control List Configuration screen in [Figure 4-5-5-2](#) appears.



**Figure 4-5-5-2:** Access Control List Configuration Page Screenshot

The page includes the following fields:

Object	Description
• ACE	Indicates the ACE ID.
• Ingress Port	Indicates the ingress port of the ACE. Possible values are: <ul style="list-style-type: none"> <li>■ <b>All</b>: The ACE will match all ingress port.</li> <li>■ <b>Port</b>: The ACE will match a specific ingress port.</li> </ul>
• Policy / Bitmask	Indicates the policy number and bitmask of the ACE.
• Frame Type	Indicates the frame type of the ACE. Possible values are: <ul style="list-style-type: none"> <li>■ <b>Any</b>: The ACE will match any frame type.</li> <li>■ <b>EType</b>: The ACE will match Ethernet Type frames. Note that an Ethernet Type based ACE will not get matched by IP and ARP frames.</li> <li>■ <b>ARP</b>: The ACE will match ARP/RARP frames.</li> <li>■ <b>IPv4</b>: The ACE will match all IPv4 frames.</li> <li>■ <b>IPv4/ICMP</b>: The ACE will match IPv4 frames with ICMP protocol.</li> <li>■ <b>IPv4/UDP</b>: The ACE will match IPv4 frames with UDP protocol.</li> <li>■ <b>IPv4/TCP</b>: The ACE will match IPv4 frames with TCP protocol.</li> <li>■ <b>IPv4/Other</b>: The ACE will match IPv4 frames, which are not ICMP/UDP/TCP.</li> <li>■ <b>IPv6</b>: The ACE will match all IPv6 standard frames.</li> </ul>
• Action	Indicates the forwarding action of the ACE. <ul style="list-style-type: none"> <li>■ <b>Permit</b>: Frames matching the ACE may be forwarded and learned.</li> <li>■ <b>Deny</b>: Frames matching the ACE are dropped.</li> </ul>



	<p>■ <b>Filter</b>: Frames matching the ACE are filtered.</p>
<ul style="list-style-type: none"> <li>• <b>Rate Limiter</b></li> </ul>	<p>Indicates the rate limiter number of the ACE. The allowed range is 1 to 16. When Disabled is displayed, the rate limiter operation is disabled.</p>
<ul style="list-style-type: none"> <li>• <b>Port Redirect</b></li> </ul>	<p>Indicates the port redirect operation of the ACE. Frames matching the ACE are redirected to the port number.</p> <p>The allowed values are <b>Disabled</b> or a specific port number. When <b>Disabled</b> is displayed, the port redirect operation is disabled.</p>
<ul style="list-style-type: none"> <li>• <b>Mirror</b></li> </ul>	<p>Specify the mirror operation of this port. Frames matching the ACE are mirrored to the destination mirror port. The allowed values are:</p> <p><b>Enabled</b>: Frames received on the port are mirrored.</p> <p><b>Disabled</b>: Frames received on the port are not mirrored.</p> <p>The default value is "Disabled".</p>
<ul style="list-style-type: none"> <li>• <b>Counter</b></li> </ul>	<p>The counter indicates the number of times the ACE was hit by a frame.</p>
<ul style="list-style-type: none"> <li>• <b>Modification Buttons</b></li> </ul>	<p>You can modify each ACE (Access Control Entry) in the table using the following buttons:</p> <ul style="list-style-type: none"> <li>⊕: Inserts a new ACE before the current row.</li> <li>⊖: Edits the ACE row.</li> <li>↑: Moves the ACE up the list.</li> <li>↓: Moves the ACE down the list.</li> <li>⊗: Deletes the ACE.</li> <li>⊕: The lowest plus sign adds a new entry at the bottom of the ACE listings.</li> </ul>

**Buttons**

Auto-refresh  Check this box to refresh the page automatically. Automatic refresh occurs every 3 seconds.

: Click to refresh the page; any changes made locally will be undone.

: Click to clear the counters.

: Click to remove all ACEs.

### 4.5.5.3 ACE Configuration

Configure an **ACE (Access Control Entry)** on this page. An ACE consists of several parameters. These parameters vary according to the frame type that you select. First select the ingress port for the ACE, and then select the frame type. Different parameter options are displayed depending on the frame type selected. A frame that hits this ACE matches the configuration that is defined here. The ACE Configuration screen in [Figure 4-5-5-3](#) appears.

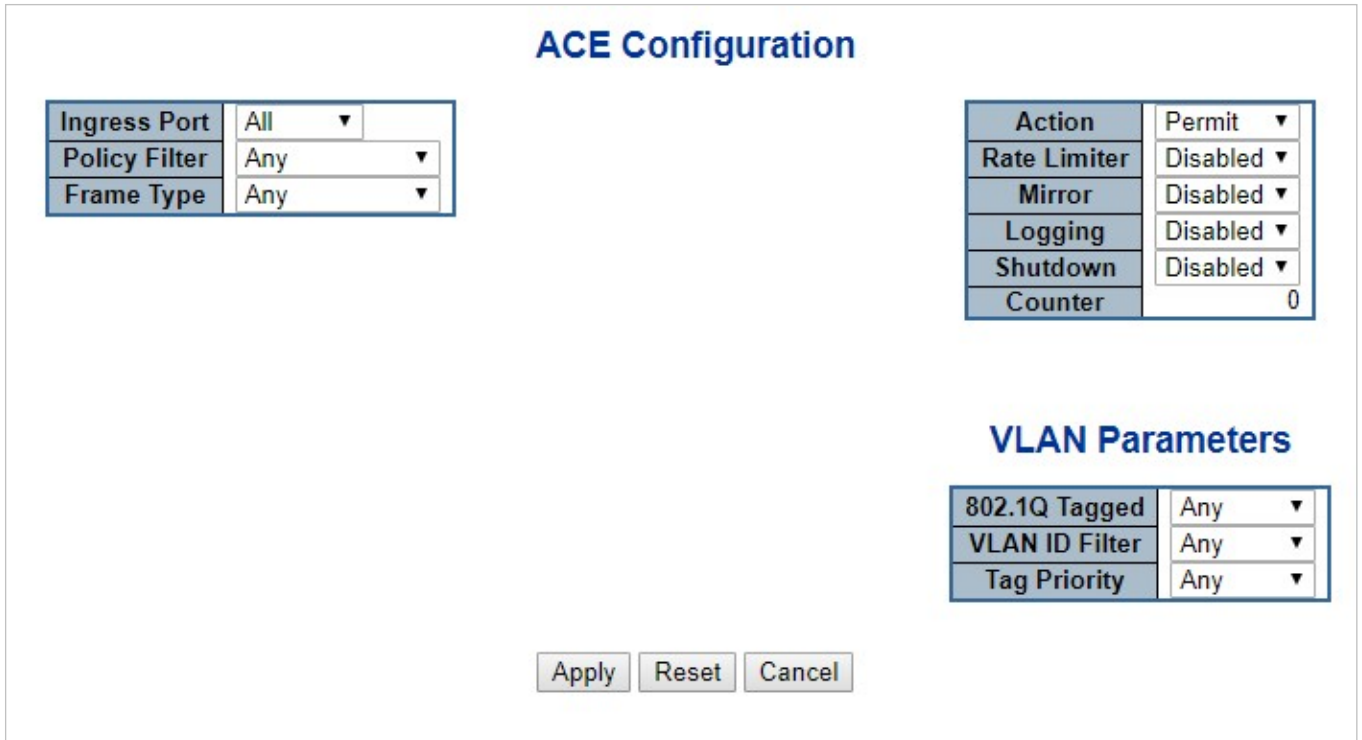

Figure 4-5-5-3: ACE Configuration Page Screenshot

The page includes the following fields:

Object	Description
<ul style="list-style-type: none"> <li><b>Ingress Port</b></li> </ul>	Select the ingress port for which this ACE applies. <ul style="list-style-type: none"> <li>■ <b>Any</b>: The ACE applies to any port.</li> <li>■ <b>Port n</b>: The ACE applies to this port number, where n is the number of the switch port.</li> </ul>
<ul style="list-style-type: none"> <li><b>Policy Filter</b></li> </ul>	Specify the policy number filter for this ACE. <ul style="list-style-type: none"> <li>■ <b>Any</b>: No policy filter is specified. (policy filter status is "don't-care".)</li> <li>■ <b>Specific</b>: If you want to filter a specific policy with this ACE, choose this value. Two field for entering an policy value and bitmask appears.</li> </ul>
<ul style="list-style-type: none"> <li><b>Policy Value</b></li> </ul>	When "Specific" is selected for the policy filter, you can enter a specific policy value. The allowed range is <b>0</b> to <b>255</b> .
<ul style="list-style-type: none"> <li><b>Policy Bitmask</b></li> </ul>	When "Specific" is selected for the policy filter, you can enter a specific policy bitmask. The allowed range is <b>0x0</b> to <b>0xff</b> .
<ul style="list-style-type: none"> <li><b>Frame Type</b></li> </ul>	Select the frame type for this ACE. These frame types are mutually exclusive. <ul style="list-style-type: none"> <li>■ <b>Any</b>: Any frame can match this ACE.</li> </ul>

	<ul style="list-style-type: none"> <li>■ <b>Ethernet Type:</b> Only Ethernet Type frames can match this ACE. The IEEE 802.3 describes the value of Length/Type Field specifications to be greater than or equal to 1536 decimal (equal to 0600 hexadecimal).</li> <li>■ <b>ARP:</b> Only ARP frames can match this ACE. Notice the ARP frames won't match the ACE with Ethernet type.</li> <li>■ <b>IPv4:</b> Only IPv4 frames can match this ACE. Notice the IPv4 frames won't match the ACE with Ethernet type.</li> <li>■ <b>IPv6:</b> Only IPv6 frames can match this ACE. Notice the IPv6 frames won't match the ACE with Ethernet type.</li> </ul>
• <b>Action</b>	<p>Specify the action to take with a frame that hits this ACE.</p> <ul style="list-style-type: none"> <li>■ <b>Permit:</b> The frame that hits this ACE is granted permission for the ACE operation.</li> <li>■ <b>Deny:</b> The frame that hits this ACE is dropped.</li> </ul>
• <b>Rate Limiter</b>	<p>Specify the rate limiter in number of base units.</p> <p>The allowed range is 1 to 16.</p> <p>Disabled indicates that the rate limiter operation is disabled.</p>
• <b>Port Redirect</b>	<p>Frames that hit the ACE are redirected to the port number specified here.</p> <p>The allowed range is the same as the switch port number range.</p> <p>Disabled indicates that the port redirect operation is disabled.</p>
• <b>Mirror</b>	<p>Specify the mirror operation of this port. Frames matching the ACE are mirrored to the destination mirror port. The rate limiter will not affect frames on the mirror port. The allowed values are:</p> <p><b>Enabled:</b> Frames received on the port are mirrored.</p> <p><b>Disabled:</b> Frames received on the port are not mirrored.</p> <p>The default value is "Disabled"</p>
• <b>Logging</b>	<p>Specify the logging operation of the ACE. The allowed values are:</p> <ul style="list-style-type: none"> <li>■ <b>Enabled:</b> Frames matching the ACE are stored in the System Log.</li> <li>■ <b>Disabled:</b> Frames matching the ACE are not logged.</li> </ul> <p><b>Note:</b> The logging feature only works when the packet length is less than 1518(without VLAN tags) and the System Log memory size and logging rate is limited.</p>
• <b>Shutdown</b>	<p>Specify the port shut down operation of the ACE. The allowed values are:</p> <ul style="list-style-type: none"> <li>■ <b>Enabled:</b> If a frame matches the ACE, the ingress port will be disabled.</li> <li>■ <b>Disabled:</b> Port shut down is disabled for the ACE.</li> </ul> <p><b>Note:</b> The shutdown feature only works when the packet length is less than 1518(without VLAN tags).</p>
• <b>Counter</b>	<p>The counter indicates the number of times the ACE was hit by a frame.</p>

■ **MAC Parameters**

Object	Description
<ul style="list-style-type: none"> <li>• <b>SMAC Filter</b></li> </ul>	<p>(Only displayed when the frame type is Ethernet Type or ARP.)</p> <p>Specify the source MAC filter for this ACE.</p> <ul style="list-style-type: none"> <li>■ <b>Any</b>: No SMAC filter is specified. (SMAC filter status is "don't-care".)</li> <li>■ <b>Specific</b>: If you want to filter a specific source MAC address with this ACE, choose this value. A field for entering an SMAC value appears.</li> </ul>
<ul style="list-style-type: none"> <li>• <b>SMAC Value</b></li> </ul>	<p>When "Specific" is selected for the SMAC filter, you can enter a specific source MAC address. The legal format is "xx-xx-xx-xx-xx-xx" or "xx.xx.xx.xx.xx.xx" or "xxxxxxxxxxx" (x is a hexadecimal digit). A frame that hits this ACE matches this SMAC value.</p>
<ul style="list-style-type: none"> <li>• <b>DMAC Filter</b></li> </ul>	<p>Specify the destination MAC filter for this ACE.</p> <ul style="list-style-type: none"> <li>■ <b>Any</b>: No DMAC filter is specified. (DMAC filter status is "don't-care".)</li> <li>■ <b>MC</b>: Frame must be multicast.</li> <li>■ <b>BC</b>: Frame must be broadcast.</li> <li>■ <b>UC</b>: Frame must be unicast.</li> <li>■ <b>Specific</b>: If you want to filter a specific destination MAC address with this ACE, choose this value. A field for entering a DMAC value appears.</li> </ul>
<ul style="list-style-type: none"> <li>• <b>DMAC Value</b></li> </ul>	<p>When "Specific" is selected for the DMAC filter, you can enter a specific destination MAC address. The legal format is "xx-xx-xx-xx-xx-xx" or "xx.xx.xx.xx.xx.xx" or "xxxxxxxxxxx" (x is a hexadecimal digit). A frame that hits this ACE matches this DMAC value.</p>

■ **VLAN Parameters**

Object	Description
<ul style="list-style-type: none"> <li>• <b>802.1Q Tagged</b></li> </ul>	<p>Specify whether frames can hit the action according to the 802.1Q tagged. The allowed values are:</p> <ul style="list-style-type: none"> <li><b>Any</b>: Any value is allowed ("don't-care").</li> <li><b>Enabled</b>: Tagged frame only.</li> <li><b>Disabled</b>: Untagged frame only.</li> </ul> <p>The default value is "Any".</p>
<ul style="list-style-type: none"> <li>• <b>VLAN ID Filter</b></li> </ul>	<p>Specify the VLAN ID filter for this ACE.</p> <ul style="list-style-type: none"> <li>■ <b>Any</b>: No VLAN ID filter is specified. (VLAN ID filter status is "don't-care".)</li> <li>■ <b>Specific</b>: If you want to filter a specific VLAN ID with this ACE, choose this value. A field for entering a VLAN ID number appears.</li> </ul>
<ul style="list-style-type: none"> <li>• <b>VLAN ID</b></li> </ul>	<p>When "Specific" is selected for the VLAN ID filter, you can enter a specific VLAN ID number. The allowed range is 1 to 4095. A frame that hits this ACE matches this VLAN ID value.</p>
<ul style="list-style-type: none"> <li>• <b>Tag Priority</b></li> </ul>	<p>Specify the tag priority for this ACE. A frame that hits this ACE matches this tag priority.</p>

	The allowed number range is 0 to 7. The value Any means that no tag priority is specified (tag priority is "don't-care").
--	---

■ **ARP Parameters**

The ARP parameters can be configured when Frame Type "ARP" is selected.

Object	Description
<ul style="list-style-type: none"> <li>• <b>ARP/RARP</b></li> </ul>	<p>Specify the available ARP/RARP opcode (OP) flag for this ACE.</p> <ul style="list-style-type: none"> <li>■ <b>Any:</b> No ARP/RARP OP flag is specified. (OP is "don't-care".)</li> <li>■ <b>ARP:</b> Frame must have ARP/RARP opcode set to ARP.</li> <li>■ <b>RARP:</b> Frame must have ARP/RARP opcode set to RARP.</li> <li>■ <b>Other:</b> Frame has unknown ARP/RARP Opcode flag.</li> </ul>
<ul style="list-style-type: none"> <li>• <b>Request/Reply</b></li> </ul>	<p>Specify the available ARP/RARP opcode (OP) flag for this ACE.</p> <ul style="list-style-type: none"> <li>■ <b>Any:</b> No ARP/RARP OP flag is specified. (OP is "don't-care".)</li> <li>■ <b>Request:</b> Frame must have ARP Request or RARP Request OP flag set.</li> <li>■ <b>Reply:</b> Frame must have ARP Reply or RARP Reply OP flag.</li> </ul>
<ul style="list-style-type: none"> <li>• <b>Sender IP Filter</b></li> </ul>	<p>Specify the sender IP filter for this ACE.</p> <ul style="list-style-type: none"> <li>■ <b>Any:</b> No sender IP filter is specified. (Sender IP filter is "don't-care".)</li> <li>■ <b>Host:</b> Sender IP filter is set to Host. Specify the sender IP address in the SIP Address field that appears.</li> <li>■ <b>Network:</b> Sender IP filter is set to Network. Specify the sender IP address and sender IP mask in the SIP Address and SIP Mask fields that appear.</li> </ul>
<ul style="list-style-type: none"> <li>• <b>Sender IP Address</b></li> </ul>	<p>When "Host" or "Network" is selected for the sender IP filter, you can enter a specific sender IP address in dotted decimal notation.</p>
<ul style="list-style-type: none"> <li>• <b>Sender IP Mask</b></li> </ul>	<p>When "Network" is selected for the sender IP filter, you can enter a specific sender IP mask in dotted decimal notation.</p>
<ul style="list-style-type: none"> <li>• <b>Target IP Filter</b></li> </ul>	<p>Specify the target IP filter for this specific ACE.</p> <ul style="list-style-type: none"> <li>■ <b>Any:</b> No target IP filter is specified. (Target IP filter is "don't-care".)</li> <li>■ <b>Host:</b> Target IP filter is set to Host. Specify the target IP address in the Target IP Address field that appears.</li> <li>■ <b>Network:</b> Target IP filter is set to Network. Specify the target IP address and target IP mask in the Target IP Address and Target IP Mask fields that appear.</li> </ul>
<ul style="list-style-type: none"> <li>• <b>Target IP Address</b></li> </ul>	<p>When "Host" or "Network" is selected for the target IP filter, you can enter a specific target IP address in dotted decimal notation.</p>
<ul style="list-style-type: none"> <li>• <b>Target IP Mask</b></li> </ul>	<p>When "Network" is selected for the target IP filter, you can enter a specific target IP mask in dotted decimal notation.</p>
<ul style="list-style-type: none"> <li>• <b>ARP Sender MAC Match</b></li> </ul>	<p>Specify whether frames can hit the action according to their sender hardware address field (SHA) settings.</p>

	<ul style="list-style-type: none"> <li>■ <b>0</b>: ARP frames where SHA is not equal to the SMAC address.</li> <li>■ <b>1</b>: ARP frames where SHA is equal to the SMAC address.</li> <li>■ <b>Any</b>: Any value is allowed ("don't-care").</li> </ul>
<ul style="list-style-type: none"> <li>• <b>RARP Target MAC Match</b></li> </ul>	<p>Specify whether frames can hit the action according to their target hardware address field (THA) settings.</p> <ul style="list-style-type: none"> <li>■ <b>0</b>: RARP frames where THA is not equal to the SMAC address.</li> <li>■ <b>1</b>: RARP frames where THA is equal to the SMAC address.</li> <li>■ <b>Any</b>: Any value is allowed ("don't-care").</li> </ul>
<ul style="list-style-type: none"> <li>• <b>IP/Ethernet Length</b></li> </ul>	<p>Specify whether frames can hit the action according to their ARP/RARP hardware address length (HLN) and protocol address length (PLN) settings.</p> <ul style="list-style-type: none"> <li>■ <b>0</b>: ARP/RARP frames where the HLN is equal to Ethernet (0x06) and the (PLN) is equal to IPv4 (0x04).</li> <li>■ <b>1</b>: ARP/RARP frames where the HLN is equal to Ethernet (0x06) and the (PLN) is equal to IPv4 (0x04).</li> <li>■ <b>Any</b>: Any value is allowed ("don't-care").</li> </ul>
<ul style="list-style-type: none"> <li>• <b>IP</b></li> </ul>	<p>Specify whether frames can hit the action according to their ARP/RARP hardware address space (HRD) settings.</p> <ul style="list-style-type: none"> <li>■ <b>0</b>: ARP/RARP frames where the HLD is equal to Ethernet (1).</li> <li>■ <b>1</b>: ARP/RARP frames where the HLD is equal to Ethernet (1).</li> <li>■ <b>Any</b>: Any value is allowed ("don't-care").</li> </ul>
<ul style="list-style-type: none"> <li>• <b>Ethernet</b></li> </ul>	<p>Specify whether frames can hit the action according to their ARP/RARP protocol address space (PRO) settings.</p> <ul style="list-style-type: none"> <li>■ <b>0</b>: ARP/RARP frames where the PRO is equal to IP (0x800).</li> <li>■ <b>1</b>: ARP/RARP frames where the PRO is equal to IP (0x800).</li> <li>■ <b>Any</b>: Any value is allowed ("don't-care").</li> </ul>

■ **IP Parameters**

The IP parameters can be configured when Frame Type "IPv4" is selected.

Object	Description
<ul style="list-style-type: none"> <li>• <b>IP Protocol Filter</b></li> </ul>	<p>Specify the IP protocol filter for this ACE.</p> <ul style="list-style-type: none"> <li>■ <b>Any</b>: No IP protocol filter is specified ("don't-care").</li> <li>■ <b>Specific</b>: If you want to filter a specific IP protocol filter with this ACE, choose this value. A field for entering an IP protocol filter appears.</li> <li>■ <b>ICMP</b>: Select ICMP to filter IPv4 ICMP protocol frames. Extra fields for defining ICMP parameters will appear. These fields are explained later in this help file.</li> <li>■ <b>UDP</b>: Select UDP to filter IPv4 UDP protocol frames. Extra fields for defining UDP parameters will appear. These fields are explained later in this help file.</li> </ul>

	<ul style="list-style-type: none"> <li>■ <b>TCP:</b> Select TCP to filter IPv4 TCP protocol frames. Extra fields for defining TCP parameters will appear. These fields are explained later in this help file.</li> </ul>
<ul style="list-style-type: none"> <li>• <b>IP Protocol Value</b></li> </ul>	<p>When "Specific" is selected for the IP protocol value, you can enter a specific value. The allowed range is 0 to 255. A frame that hits this ACE matches this IP protocol value.</p>
<ul style="list-style-type: none"> <li>• <b>IP TTL</b></li> </ul>	<p>Specify the Time-to-Live settings for this ACE.</p> <ul style="list-style-type: none"> <li>■ <b>zero:</b> IPv4 frames with a Time-to-Live field greater than zero must not be able to match this entry.</li> <li>■ <b>non-zero:</b> IPv4 frames with a Time-to-Live field greater than zero must be able to match this entry.</li> <li>■ <b>Any:</b> Any value is allowed ("don't-care").</li> </ul>
<ul style="list-style-type: none"> <li>• <b>IP Fragment</b></li> </ul>	<p>Specify the fragment offset settings for this ACE. This involves the settings for the More Fragments (MF) bit and the Fragment Offset (FRAG OFFSET) field for an IPv4 frame.</p> <ul style="list-style-type: none"> <li>■ <b>No:</b> IPv4 frames where the MF bit is set or the FRAG OFFSET field is greater than zero must not be able to match this entry.</li> <li>■ <b>Yes:</b> IPv4 frames where the MF bit is set or the FRAG OFFSET field is greater than zero must be able to match this entry.</li> <li>■ <b>Any:</b> Any value is allowed ("don't-care").</li> </ul>
<ul style="list-style-type: none"> <li>• <b>IP Option</b></li> </ul>	<p>Specify the options flag setting for this ACE.</p> <ul style="list-style-type: none"> <li>■ <b>No:</b> IPv4 frames where the options flag is set must not be able to match this entry.</li> <li>■ <b>Yes:</b> IPv4 frames where the options flag is set must be able to match this entry.</li> <li>■ <b>Any:</b> Any value is allowed ("don't-care").</li> </ul>
<ul style="list-style-type: none"> <li>• <b>SIP Filter</b></li> </ul>	<p>Specify the source IP filter for this ACE.</p> <ul style="list-style-type: none"> <li>■ <b>Any:</b> No source IP filter is specified. (Source IP filter is "don't-care".)</li> <li>■ <b>Host:</b> Source IP filter is set to Host. Specify the source IP address in the SIP Address field that appears.</li> <li>■ <b>Network:</b> Source IP filter is set to Network. Specify the source IP address and source IP mask in the SIP Address and SIP Mask fields that appear.</li> </ul>
<ul style="list-style-type: none"> <li>• <b>SIP Address</b></li> </ul>	<p>When "Host" or "Network" is selected for the source IP filter, you can enter a specific SIP address in dotted decimal notation.</p>
<ul style="list-style-type: none"> <li>• <b>SIP Mask</b></li> </ul>	<p>When "Network" is selected for the source IP filter, you can enter a specific SIP mask in dotted decimal notation.</p>
<ul style="list-style-type: none"> <li>• <b>DIP Filter</b></li> </ul>	<p>Specify the destination IP filter for this ACE.</p> <ul style="list-style-type: none"> <li>■ <b>Any:</b> No destination IP filter is specified. (Destination IP filter is "don't-care".)</li> <li>■ <b>Host:</b> Destination IP filter is set to Host. Specify the destination IP address</li> </ul>

	<p>in the DIP Address field that appears.</p> <ul style="list-style-type: none"> <li> <b>Network:</b> Destination IP filter is set to Network. Specify the destination IP address and destination IP mask in the DIP Address and DIP Mask fields that appear.         </li> </ul>
<ul style="list-style-type: none"> <li> <b>DIP Address</b> </li> </ul>	<p>When "Host" or "Network" is selected for the destination IP filter, you can enter a specific DIP address in dotted decimal notation.</p>
<ul style="list-style-type: none"> <li> <b>DIP Mask</b> </li> </ul>	<p>When "Network" is selected for the destination IP filter, you can enter a specific DIP mask in dotted decimal notation.</p>

■ IPv6 Parameters

Object	Description
<ul style="list-style-type: none"> <li> <b>Next Header Filter</b> </li> </ul>	<p>Specify the IPv6 next header filter for this ACE.</p> <ul style="list-style-type: none"> <li> <b>Any:</b> No IPv6 next header filter is specified ("don't-care").         </li> <li> <b>Specific:</b> If you want to filter a specific IPv6 next header filter with this ACE, choose this value. A field for entering an IPv6 next header filter appears.         </li> <li> <b>ICMP:</b> Select ICMP to filter IPv6 ICMP protocol frames. Extra fields for defining ICMP parameters will appear. These fields are explained later in this help file.         </li> <li> <b>UDP:</b> Select UDP to filter IPv6 UDP protocol frames. Extra fields for defining UDP parameters will appear. These fields are explained later in this help file.         </li> <li> <b>TCP:</b> Select TCP to filter IPv6 TCP protocol frames. Extra fields for defining TCP parameters will appear. These fields are explained later in this help file.         </li> </ul>
<ul style="list-style-type: none"> <li> <b>Next Header Value</b> </li> </ul>	<p>When "Specific" is selected for the IPv6 next header value, you can enter a specific value. The allowed range is <b>0</b> to <b>255</b>. A frame that hits this ACE matches this IPv6 protocol value.</p>
<ul style="list-style-type: none"> <li> <b>SIP Filter</b> </li> </ul>	<p>Specify the source IPv6 filter for this ACE.</p> <ul style="list-style-type: none"> <li> <b>Any:</b> No source IPv6 filter is specified. (Source IPv6 filter is "don't-care".)         </li> <li> <b>Specific:</b> Source IPv6 filter is set to Network. Specify the source IPv6 address and source IPv6 mask in the SIP Address fields that appear.         </li> </ul>
<ul style="list-style-type: none"> <li> <b>SIP Address</b> </li> </ul>	<p>When "Specific" is selected for the source IPv6 filter, you can enter a specific SIPv6 address. The field only supported last 32 bits for IPv6 address.</p>
<ul style="list-style-type: none"> <li> <b>SIP BitMask</b> </li> </ul>	<p>When "Specific" is selected for the source IPv6 filter, you can enter a specific SIPv6 mask. The field only supported last 32 bits for IPv6 address. Notice the usage of bitmask, if the binary bit value is "0", it means this bit is "don't-care".</p> <p>The real matched pattern is [sipv6_address &amp; sipv6_bitmask] (last 32 bits). For example, if the SIPv6 address is 2001::3 and the SIPv6 bitmask is</p>



	0xFFFFFFFF (bit 0 is "don't-care" bit), then IPv6 address 2001::2 and 2001::3 are applied to this rule.
<ul style="list-style-type: none"> <li>• <b>Hop Limit</b></li> </ul>	<p>Specify the hop limit settings for this ACE.</p> <ul style="list-style-type: none"> <li>■ <b>zero</b>: IPv6 frames with a hop limit field greater than zero must not be able to match this entry.</li> <li>■ <b>non-zero</b>: IPv6 frames with a hop limit field greater than zero must be able to match this entry.</li> <li>■ <b>Any</b>: Any value is allowed ("don't-care").</li> </ul>

■ **ICMP Parameters**

Object	Description
<ul style="list-style-type: none"> <li>• <b>ICMP Type Filter</b></li> </ul>	<p>Specify the ICMP filter for this ACE.</p> <ul style="list-style-type: none"> <li>■ <b>Any</b>: No ICMP filter is specified (ICMP filter status is "don't-care").</li> <li>■ <b>Specific</b>: If you want to filter a specific ICMP filter with this ACE, you can enter a specific ICMP value. A field for entering an ICMP value appears.</li> </ul>
<ul style="list-style-type: none"> <li>• <b>ICMP Type Value</b></li> </ul>	<p>When "Specific" is selected for the ICMP filter, you can enter a specific ICMP value.</p> <p>The allowed range is <b>0</b> to <b>255</b>. A frame that hits this ACE matches this ICMP value.</p>
<ul style="list-style-type: none"> <li>• <b>ICMP Code Filter</b></li> </ul>	<p>Specify the ICMP code filter for this ACE.</p> <ul style="list-style-type: none"> <li>■ <b>Any</b>: No ICMP code filter is specified (ICMP code filter status is "don't-care").</li> <li>■ <b>Specific</b>: If you want to filter a specific ICMP code filter with this ACE, you can enter a specific ICMP code value. A field for entering an ICMP code value appears.</li> </ul>
<ul style="list-style-type: none"> <li>• <b>ICMP Code Value</b></li> </ul>	<p>When "Specific" is selected for the ICMP code filter, you can enter a specific ICMP code value.</p> <p>The allowed range is <b>0</b> to <b>255</b>. A frame that hits this ACE matches this ICMP code value.</p>

■ **TCP/UDP Parameters**

Object	Description
<ul style="list-style-type: none"> <li>• <b>TCP/UDP Source Filter</b></li> </ul>	<p>Specify the TCP/UDP source filter for this ACE.</p> <ul style="list-style-type: none"> <li>■ <b>Any</b>: No TCP/UDP source filter is specified (TCP/UDP source filter status is "don't-care").</li> <li>■ <b>Specific</b>: If you want to filter a specific TCP/UDP source filter with this ACE, you can enter a specific TCP/UDP source value. A field for entering a TCP/UDP source value appears.</li> </ul>

	<ul style="list-style-type: none"> <li>■ <b>Range:</b> If you want to filter a specific TCP/UDP source range filter with this ACE, you can enter a specific TCP/UDP source range value. A field for entering a TCP/UDP source value appears.</li> </ul>
<ul style="list-style-type: none"> <li>• <b>TCP/UDP Source No.</b></li> </ul>	When "Specific" is selected for the TCP/UDP source filter, you can enter a specific TCP/UDP source value. The allowed range is 0 to 65535. A frame that hits this ACE matches this TCP/UDP source value.
<ul style="list-style-type: none"> <li>• <b>TCP/UDP Source Range</b></li> </ul>	When "Range" is selected for the TCP/UDP source filter, you can enter a specific TCP/UDP source range value. The allowed range is 0 to 65535. A frame that hits this ACE matches this TCP/UDP source value.
<ul style="list-style-type: none"> <li>• <b>TCP/UDP Destination Filter</b></li> </ul>	<p>Specify the TCP/UDP destination filter for this ACE.</p> <ul style="list-style-type: none"> <li>■ <b>Any:</b> No TCP/UDP destination filter is specified (TCP/UDP destination filter status is "don't-care").</li> <li>■ <b>Specific:</b> If you want to filter a specific TCP/UDP destination filter with this ACE, you can enter a specific TCP/UDP destination value. A field for entering a TCP/UDP destination value appears.</li> <li>■ <b>Range:</b> If you want to filter a specific range TCP/UDP destination filter with this ACE, you can enter a specific TCP/UDP destination range value. A field for entering a TCP/UDP destination value appears.</li> </ul>
<ul style="list-style-type: none"> <li>• <b>TCP/UDP Destination Number</b></li> </ul>	When "Specific" is selected for the TCP/UDP destination filter, you can enter a specific TCP/UDP destination value. The allowed range is 0 to 65535. A frame that hits this ACE matches this TCP/UDP destination value.
<ul style="list-style-type: none"> <li>• <b>TCP/UDP Destination Range</b></li> </ul>	When "Range" is selected for the TCP/UDP destination filter, you can enter a specific TCP/UDP destination range value. The allowed range is 0 to 65535. A frame that hits this ACE matches this TCP/UDP destination value.
<ul style="list-style-type: none"> <li>• <b>TCP FIN</b></li> </ul>	<p>Specify the TCP "No more data from sender" (FIN) value for this ACE.</p> <ul style="list-style-type: none"> <li>■ <b>0:</b> TCP frames where the FIN field is set must not be able to match this entry.</li> <li>■ <b>1:</b> TCP frames where the FIN field is set must be able to match this entry.</li> <li>■ <b>Any:</b> Any value is allowed ("don't-care").</li> </ul>
<ul style="list-style-type: none"> <li>• <b>TCP SYN</b></li> </ul>	<p>Specify the TCP "Synchronize sequence numbers" (SYN) value for this ACE.</p> <ul style="list-style-type: none"> <li>■ <b>0:</b> TCP frames where the SYN field is set must not be able to match this entry.</li> <li>■ <b>1:</b> TCP frames where the SYN field is set must be able to match this entry.</li> <li>■ <b>Any:</b> Any value is allowed ("don't-care").</li> </ul>
<ul style="list-style-type: none"> <li>• <b>TCP RST</b></li> </ul>	<p>Specify the TCP "Reset the connection" (RST) value for this ACE.</p> <ul style="list-style-type: none"> <li>■ <b>0:</b> TCP frames where the RST field is set must not be able to match this entry.</li> <li>■ <b>1:</b> TCP frames where the RST field is set must be able to match this entry.</li> <li>■ <b>Any:</b> Any value is allowed ("don't-care").</li> </ul>
<ul style="list-style-type: none"> <li>• <b>TCP PSH</b></li> </ul>	Specify the TCP "Push Function" (PSH) value for this ACE.

	<ul style="list-style-type: none"> <li>■ <b>0</b>: TCP frames where the PSH field is set must not be able to match this entry.</li> <li>■ <b>1</b>: TCP frames where the PSH field is set must be able to match this entry.</li> <li>■ <b>Any</b>: Any value is allowed ("don't-care").</li> </ul>
<ul style="list-style-type: none"> <li>• <b>TCP ACK</b></li> </ul>	<p>Specify the TCP "Acknowledgment field significant" (ACK) value for this ACE.</p> <ul style="list-style-type: none"> <li>■ <b>0</b>: TCP frames where the ACK field is set must not be able to match this entry.</li> <li>■ <b>1</b>: TCP frames where the ACK field is set must be able to match this entry.</li> <li>■ <b>Any</b>: Any value is allowed ("don't-care").</li> </ul>
<ul style="list-style-type: none"> <li>• <b>TCP URG</b></li> </ul>	<p>Specify the TCP "Urgent Pointer field significant" (URG) value for this ACE.</p> <ul style="list-style-type: none"> <li>■ <b>0</b>: TCP frames where the URG field is set must not be able to match this entry.</li> <li>■ <b>1</b>: TCP frames where the URG field is set must be able to match this entry.</li> <li>■ <b>Any</b>: Any value is allowed ("don't-care").</li> </ul>

■ **Ethernet Type Parameters**

The Ethernet Type parameters can be configured when Frame Type "Ethernet Type" is selected.

Object	Description
<ul style="list-style-type: none"> <li>• <b>EtherType Filter</b></li> </ul>	<p>Specify the Ethernet type filter for this ACE.</p> <ul style="list-style-type: none"> <li>■ <b>Any</b>: No EtherType filter is specified (EtherType filter status is "don't-care").</li> <li>■ <b>Specific</b>: If you want to filter a specific EtherType filter with this ACE, you can enter a specific EtherType value. A field for entering a EtherType value appears.</li> </ul>
<ul style="list-style-type: none"> <li>• <b>Ethernet Type Value</b></li> </ul>	<p>When "Specific" is selected for the EtherType filter, you can enter a specific EtherType value.</p> <p>The allowed range is <b>0x600</b> to <b>0xFFFF</b> but excluding 0x800(IPv4), 0x806(ARP) and 0x86DD(IPv6). A frame that hits this ACE matches this EtherType value.</p>

**Buttons**

 : Click to apply changes

 : Click to undo any changes made locally and revert to previously saved values.

 : Return to the previous page.

**4.5.5.4 ACL Ports Configuration**

Configure the ACL parameters (ACE) of each switch port. These parameters will affect frames received on a port unless the frame matches a specific ACE. The ACL Ports Configuration screen in [Figure 4-5-5-4](#) appears.

### ACL Ports Configuration

Port	Policy ID	Action	Rate Limiter ID	Port Redirect	Mirror	Logging	Shutdown	State	Counter
*	0	<All> ▼	<All> ▼	<All> ▼	<All> ▼	<All> ▼	<All> ▼	<All> ▼	*
1	0	Permit ▼	Disabled ▼	Disabled ▼	Disabled ▼	Disabled ▼	Disabled ▼	Enabled ▼	0
2	0	Permit ▼	Disabled ▼	Disabled ▼	Disabled ▼	Disabled ▼	Disabled ▼	Enabled ▼	18006
3	0	Permit ▼	Disabled ▼	Disabled ▼	Disabled ▼	Disabled ▼	Disabled ▼	Enabled ▼	0
4	0	Permit ▼	Disabled ▼	Disabled ▼	Disabled ▼	Disabled ▼	Disabled ▼	Enabled ▼	0
5	0	Permit ▼	Disabled ▼	Disabled ▼	Disabled ▼	Disabled ▼	Disabled ▼	Enabled ▼	0
6	0	Permit ▼	Disabled ▼	Disabled ▼	Disabled ▼	Disabled ▼	Disabled ▼	Enabled ▼	0
7	0	Permit ▼	Disabled ▼	Disabled ▼	Disabled ▼	Disabled ▼	Disabled ▼	Enabled ▼	0

Figure 4-5-5-4: ACL Ports Configuration Page Screenshot

The page includes the following fields:

Object	Description
<ul style="list-style-type: none"> <li>• <b>Port</b></li> </ul>	The logical port for the settings contained in the same row.
<ul style="list-style-type: none"> <li>• <b>Policy ID</b></li> </ul>	Select the policy to apply to this port. The allowed values are <b>0</b> through <b>255</b> . The default value is 0.
<ul style="list-style-type: none"> <li>• <b>Action</b></li> </ul>	Select whether forwarding is permitted ("Permit") or denied ("Deny"). The default value is "Permit".
<ul style="list-style-type: none"> <li>• <b>Rate Limiter ID</b></li> </ul>	Select which rate limiter to apply on this port. The allowed values are <b>Disabled</b> or the values <b>1</b> through <b>16</b> . The default value is "Disabled".
<ul style="list-style-type: none"> <li>• <b>Port Redirect</b></li> </ul>	Select which port frames are redirected on. The allowed values are Disabled or a specific port number and it can't be set when action is permitted. The default value is "Disabled".
<ul style="list-style-type: none"> <li>• <b>Mirror</b></li> </ul>	Specify the mirror operation of this port. The allowed values are: <b>Enabled</b> : Frames received on the port are mirrored. <b>Disabled</b> : Frames received on the port are not mirrored. The default value is "Disabled".
<ul style="list-style-type: none"> <li>• <b>Logging</b></li> </ul>	Specify the logging operation of this port. The allowed values are: <ul style="list-style-type: none"> <li>■ <b>Enabled</b>: Frames received on the port are stored in the System Log.</li> <li>■ <b>Disabled</b>: Frames received on the port are not logged.</li> </ul> The default value is "Disabled".  <b>Please note that the System Log memory size and logging rate are limited.</b>
<ul style="list-style-type: none"> <li>• <b>Shutdown</b></li> </ul>	Specify the port shut down operation of this port. The allowed values are: <ul style="list-style-type: none"> <li>■ <b>Enabled</b>: If a frame is received on the port, the port will be disabled.</li> <li>■ <b>Disabled</b>: Port shut down is disabled.</li> </ul>

	The default value is "Disabled".
<ul style="list-style-type: none"> <li>• <b>State</b></li> </ul>	<p>Specify the port state of this port. The allowed values are:</p> <ul style="list-style-type: none"> <li>■ <b>Enabled</b>: To reopen ports by changing the volatile port configuration of the ACL user module.</li> <li>■ <b>Disabled</b>: To close ports by changing the volatile port configuration of the ACL user module.</li> </ul> <p>The default value is "Enabled".</p>
<ul style="list-style-type: none"> <li>• <b>Counter</b></li> </ul>	Counts the number of frames that match this ACE.

**Buttons**

 : Click to apply changes

 : Click to undo any changes made locally and revert to previously saved values.

 : Click to refresh the page; any changes made locally will be undone.

 : Click to clear the counters.

#### 4.5.5.5 ACL Rate Limiters

Configure the rate limiter for the ACL of the switch.

The ACL Rate Limiter Configuration screen in [Figure 4-5-5-5](#) appears.

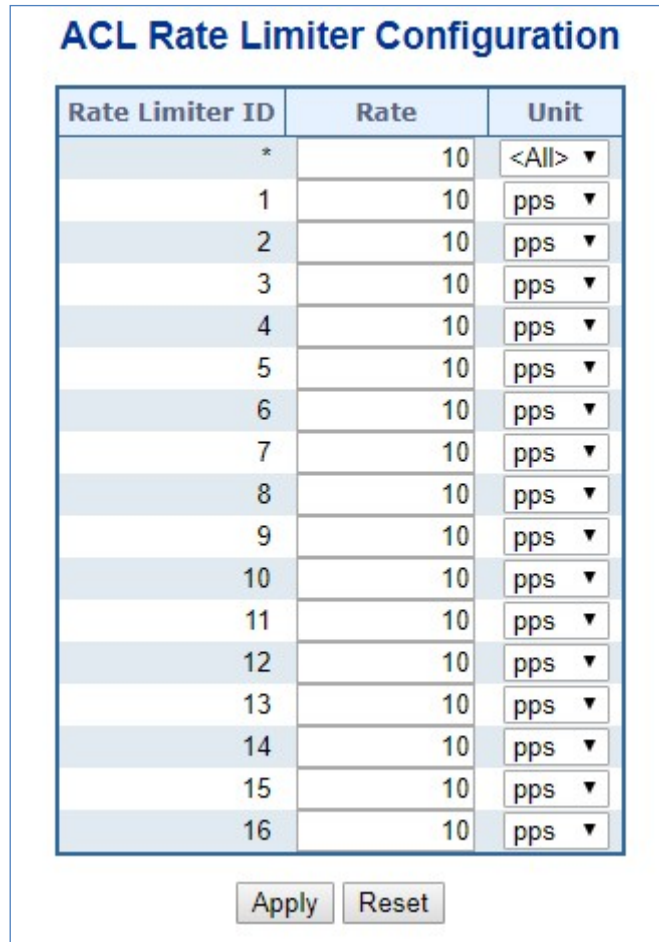

Figure 4-5-5-5: ACL Rate Limiter Configuration Page Screenshot

The page includes the following fields:

Object	Description
• Rate Limiter ID	The rate limiter ID for the settings contained in the same row.
• Rate (pps)	The allowed values are: <b>0-3276700</b> in pps or <b>0, 100, 200, 300, ..., 1000000</b> in kbps.
• Unit	Specify the rate unit. The allowed values are: <b>pps</b> : packets per second. <b>kbps</b> : Kbits per second.

#### Buttons

: Click to apply changes

: Click to undo any changes made locally and revert to previously saved values.

### 4.5.6 DHCP Snooping

DHCP Snooping is used to block intruder on the untrusted ports of DUT when it tries to intervene by injecting a bogus DHCP reply packet to a legitimate conversation between the DHCP client and server.

#### DHCP Snooping Overview

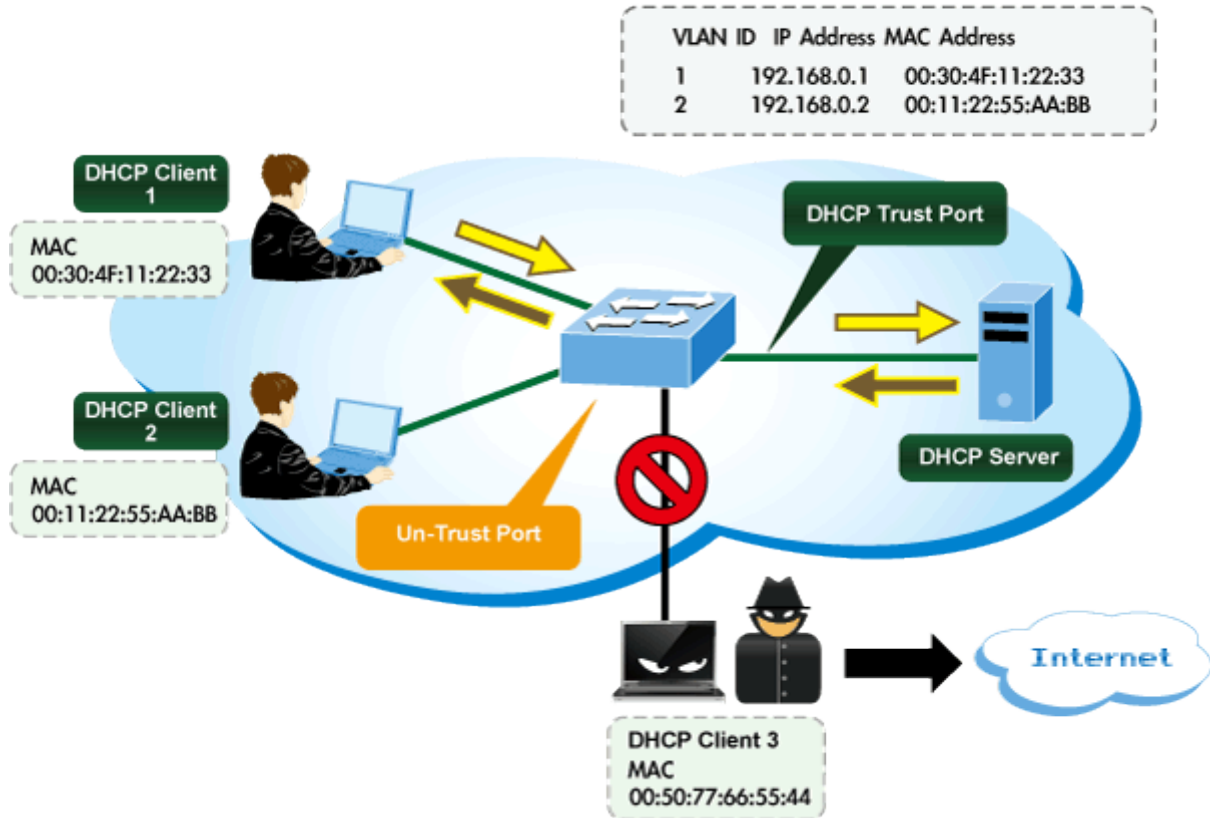

#### 4.5.6.1 DHCP Snooping Configuration

Configure DHCP Snooping on this page. in [Figure 4-5-6-1](#) appears.

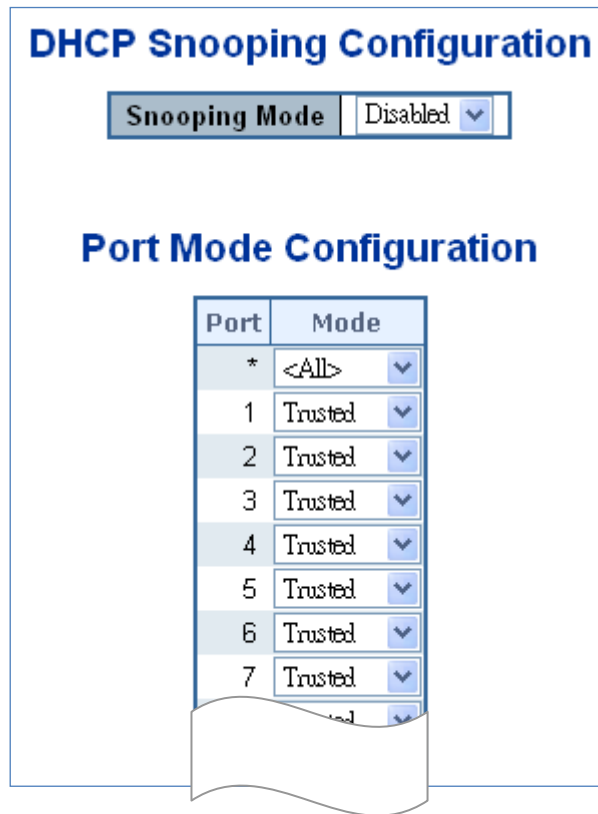



Figure 4-5-6-1: DHCP Snooping Configuration Screen Page Screenshot

The page includes the following fields:

Object	Description
<ul style="list-style-type: none"> <li><b>Snooping Mode</b></li> </ul>	<p>Indicates the DHCP snooping mode operation. Possible modes are:</p> <ul style="list-style-type: none"> <li>■ <b>Enabled</b>: Enable DHCP snooping mode operation. When enable DHCP snooping mode operation, the request DHCP messages will be forwarded to trusted ports and only allowed reply packets from trusted ports.</li> <li>■ <b>Disabled</b>: Disable DHCP snooping mode operation.</li> </ul>
<ul style="list-style-type: none"> <li><b>Port Mode Configuration</b></li> </ul>	<p>Indicates the DHCP snooping port mode. Possible port modes are:</p> <ul style="list-style-type: none"> <li>■ <b>Trusted</b>: Configures the port as trusted sources of the DHCP message.</li> <li>■ <b>Untrusted</b>: Configures the port as untrusted sources of the DHCP message.</li> </ul>

**Buttons**

 : Click to apply changes

 : Click to undo any changes made locally and revert to previously saved values.



### 4.5.6.2 Snooping Table

This page display the dynamic IP assigned information after DHCP Snooping mode is disabled. All DHCP clients obtained the dynamic IP address from the DHCP server will be listed in this table except for local VLAN interface IP addresses. Entries in the Dynamic DHCP snooping Table are shown on this page. The Dynamic DHCP Snooping Table screen in [Figure 4-5-6-2](#) appears.

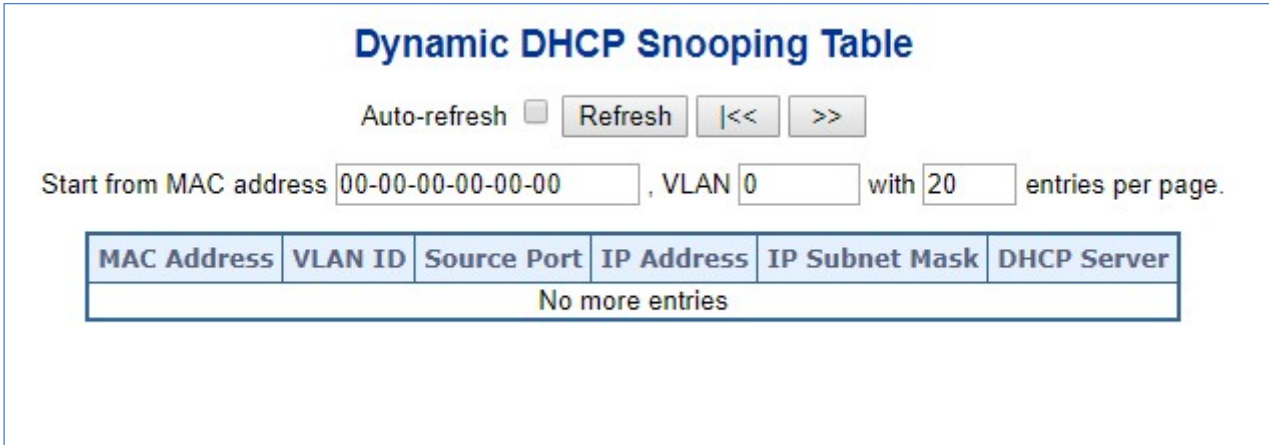

Figure 4-5-6-2: Dynamic DHCP Snooping Table Screen Page Screenshot

Object	Description
• <b>MAC Address</b>	User MAC address of the entry.
• <b>VLAN ID</b>	VLAN-ID in which the DHCP traffic is permitted.
• <b>Source Port</b>	Switch Port Number for which the entries are displayed.
• <b>IP Address</b>	User IP address of the entry.
• <b>IP Subnet Mask</b>	User IP subnet mask of the entry.
• <b>DHCP Server Address</b>	DHCP Server address of the entry.

#### Buttons

Auto-refresh : Check this box to refresh the page automatically. Automatic refresh occurs every 3 seconds.

**Refresh**: Refreshes the displayed table starting from the input fields

**Clear**: Flushes all dynamic entries.

**>>**: It will use the last entry of the currently displayed table as a basis for the next lookup. When the end is reached the text "No more entries" is shown in the displayed table

**<<**: To start over

## 4.5.7 IP Source Guard

### 4.5.7.1 IP Source Guard Configuration

IP Source Guard is a secure feature used to restrict IP traffic on **DHCP snooping untrusted ports** by filtering traffic based on the DHCP Snooping Table or manually configured IP Source Bindings. It helps prevent IP spoofing attacks when a host tries to spoof and use the IP address of another host. This page provides IP Source Guard related configuration. The IP Source Guard Configuration screen in [Figure 4-5-7-1](#) appears.

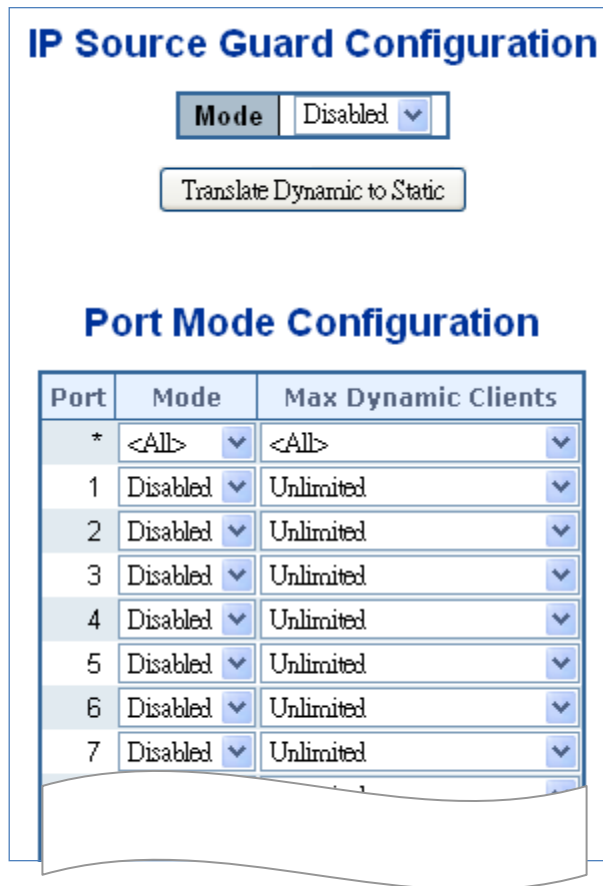

**IP Source Guard Configuration**

Mode: Disabled

Translate Dynamic to Static

**Port Mode Configuration**

Port	Mode	Max Dynamic Clients
*	<All>	<All>
1	Disabled	Unlimited
2	Disabled	Unlimited
3	Disabled	Unlimited
4	Disabled	Unlimited
5	Disabled	Unlimited
6	Disabled	Unlimited
7	Disabled	Unlimited

Figure 4-5-7-1: IP Source Guard Configuration Screen Page Screenshot

The page includes the following fields:

Object	Description
<ul style="list-style-type: none"> <li>• <b>Mode of IP Source Guard Configuration</b></li> </ul>	Enable the Global IP Source Guard or disable the Global IP Source Guard. All configured ACEs will be lost when the mode is enabled.
<ul style="list-style-type: none"> <li>• <b>Port Mode Configuration</b></li> </ul>	Specify IP Source Guard is enabled on which ports. Only when both Global Mode and Port Mode on a given port are enabled, IP Source Guard is enabled on this given port.
<ul style="list-style-type: none"> <li>• <b>Max Dynamic Clients</b></li> </ul>	Specify the maximum number of dynamic clients can be learned on given ports. This value can be 0, 1, 2 and unlimited. If the port mode is enabled and the value of max dynamic client is equal 0, it means only allow the IP packets forwarding

	that are matched in static entries on the specific port.
--	--

**Buttons**

- : Click to translate all dynamic entries to static entries.
- : Click to apply changes
- : Click to undo any changes made locally and revert to previously saved values.

**4.5.7.2 Static IP Source Guard Table**

This page provides Static IP Source Guard Table. The Static IP Source Guard Table screen in [Figure 4-5-7-2](#) appears.

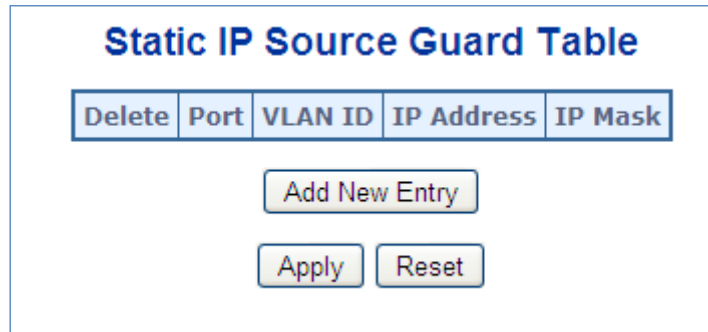

**Figure 4-5-7-2:** Static IP Source Guard Table Screen Page Screenshot

The page includes the following fields:

Object	Description
• <b>Delete</b>	Check to delete the entry. It will be deleted during the next save.
• <b>Port</b>	The logical port for the settings.
• <b>VLAN ID</b>	The VLAN ID for the settings.
• <b>IP Address</b>	Allowed Source IP address.
• <b>MAC Address</b>	Allowed Source MAC address.

**Buttons**

- : Click to add a new entry to the Static IP Source Guard table.
- : Click to apply changes
- : Click to undo any changes made locally and revert to previously saved values.

### 4.5.7.3 Dynamic IP Source Guard Table

This page provides Static IP Source Guard Table. The Static IP Source Guard Table screen in [Figure 4-5-7-3](#) appears.

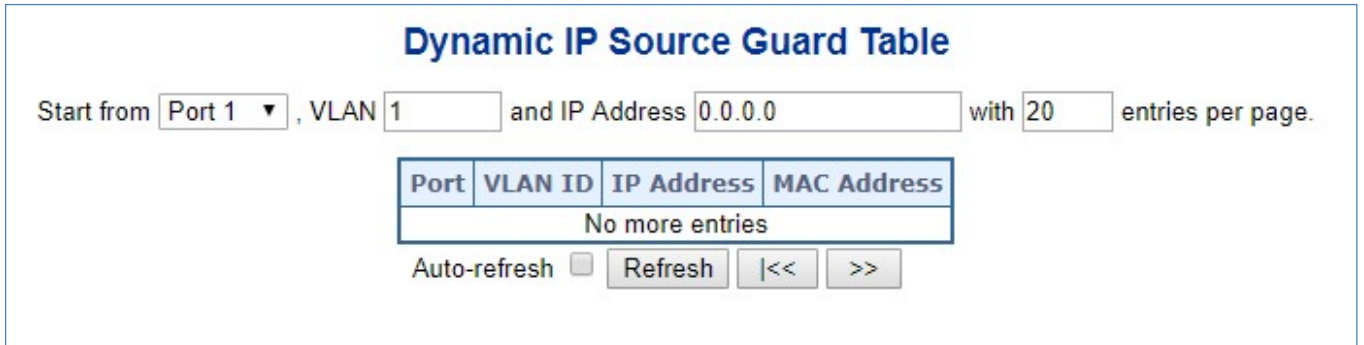

**Figure 4-5-7-3:** Static IP Source Guard Table Screen Page Screenshot

The page includes the following fields:

Object	Description
• Port	Switch Port Number for which the entries are displayed.
• VLAN ID	VLAN-ID in which the IP traffic is permitted.
• IP Address	User IP address of the entry.
• MAC Address	Source MAC address.

#### Buttons

Auto-refresh  : Check this box to refresh the page automatically. Automatic refresh occurs every 3 seconds

**Refresh** : Refreshes the displayed table starting from the input fields..

**Clear** : Flushes all dynamic entries.

**>>** : Updates the table starting from the first entry in the Dynamic IP Source Guard Table.

**|<<** : Updates the table, starting with the entry after the last entry currently displayed.

## 4.5.8 ARP Inspection

### 4.5.8.1 ARP Inspection

ARP Inspection is a secure feature. Several types of attacks can be launched against a host or devices connected to Layer 2 networks by "poisoning" the ARP caches. This feature is used to block such attacks. Only valid ARP requests and responses can go through DUT. This page provides ARP Inspection related configuration. The ARP Inspection Configuration screen in [Figure 4-5-8-1](#) appears.

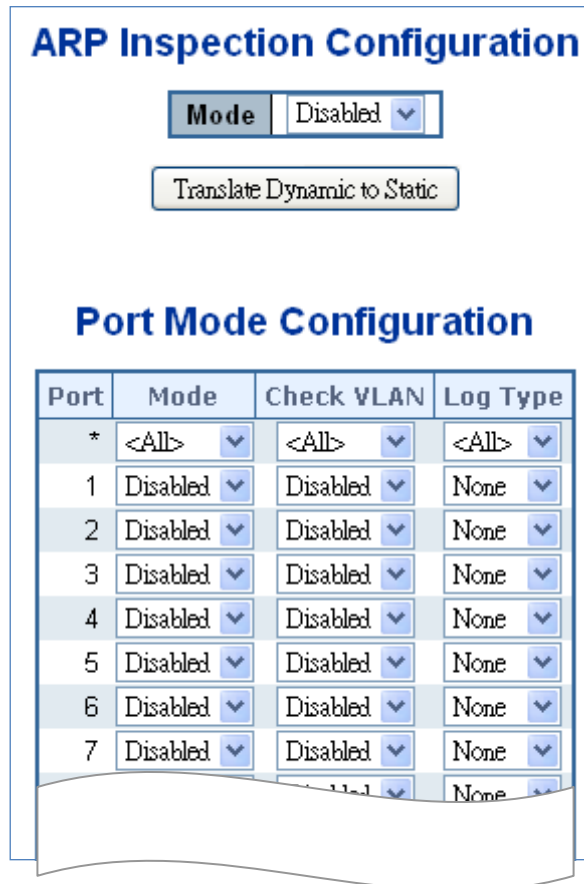

**ARP Inspection Configuration**

Mode:  ▼

**Port Mode Configuration**

Port	Mode	Check VLAN	Log Type
*	<All> ▼	<All> ▼	<All> ▼
1	Disabled ▼	Disabled ▼	None ▼
2	Disabled ▼	Disabled ▼	None ▼
3	Disabled ▼	Disabled ▼	None ▼
4	Disabled ▼	Disabled ▼	None ▼
5	Disabled ▼	Disabled ▼	None ▼
6	Disabled ▼	Disabled ▼	None ▼
7	Disabled ▼	Disabled ▼	None ▼

Figure 4-5-8-1: ARP Inspection Configuration Screen Page Screenshot

The page includes the following fields:

Object	Description
<ul style="list-style-type: none"> <li>• <b>Mode of ARP Inspection Configuration</b></li> </ul>	Enable the Global ARP Inspection or disable the Global ARP Inspection.
<ul style="list-style-type: none"> <li>• <b>Port Mode Configuration</b></li> </ul>	<p>Specify ARP Inspection is enabled on which ports. Only when both Global Mode and Port Mode on a given port are enabled, ARP Inspection is enabled on this given port. Possible <b>modes</b> are:</p> <ul style="list-style-type: none"> <li>■ <b>Enabled</b>: Enable ARP Inspection operation.</li> <li>■ <b>Disabled</b>: Disable ARP Inspection operation.</li> </ul>

If you want to inspect the VLAN configuration, you have to enable the setting of "Check VLAN". The default setting of "Check VLAN" is disabled. When the setting of "Check VLAN" is disabled, the log type of ARP Inspection will refer to the port setting. And the setting of "Check VLAN" is enabled, the log type of ARP Inspection will refer to the VLAN setting. Possible setting of "Check VLAN" are:

- **Enabled**: Enable check VLAN operation.
- **Disabled**: Disable check VLAN operation.

Only the Global Mode and Port Mode on a given port are enabled, and the setting of "Check VLAN" is disabled, the log type of ARP Inspection will refer to the port setting. There are four **log types** and possible types are:

- **None**: Log nothing.
- **Deny**: Log denied entries.
- **Permit**: Log permitted entries.
- **ALL**: Log all entries.

**Buttons**

**Translate Dynamic to Static**: Click to translate all dynamic entries to static entries.

**Apply**: Click to apply changes

**Reset**: Click to undo any changes made locally and revert to previously saved values.

**4.5.8.2 ARP Inspection Static Table**

This page provides Static ARP Inspection Table. The Static ARP Inspection Table screen in [Figure 4-5-8-2](#) appears.

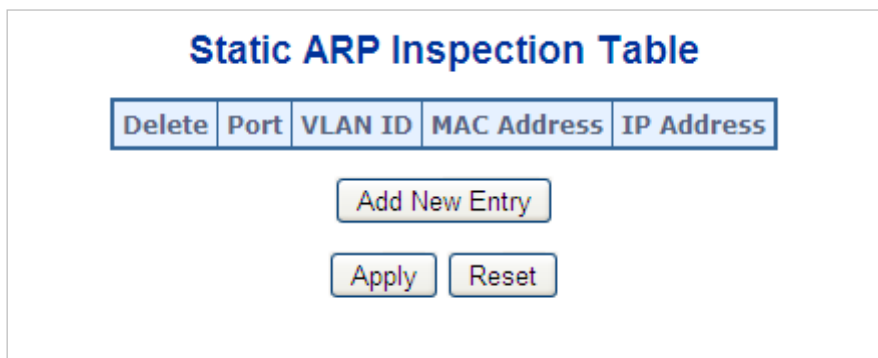

**Figure 4-5-8-2:** Static ARP Inspection Table Screen Page Screenshot

The page includes the following fields:

Object	Description
• <b>Delete</b>	Check to delete the entry. It will be deleted during the next save.
• <b>Port</b>	The logical port for the settings.
• <b>VLAN ID</b>	The VLAN ID for the settings.
• <b>MAC Address</b>	Allowed Source MAC address in ARP request packets.
• <b>IP Address</b>	Allowed Source IP address in ARP request packets.

**Buttons**

**Add New Entry**

: Click to add a new entry to the Static ARP Inspection table.

**Apply**

: Click to apply changes

**Reset**

: Click to undo any changes made locally and revert to previously saved values.

**4.5.8.3 Dynamic ARP Inspection Table**

Entries in the Dynamic ARP Inspection Table are shown on this page. The Dynamic ARP Inspection Table contains up to 1024 entries, and is sorted first by port, then by VLAN ID, then by MAC address, and then by IP address. The Dynamic ARP Inspection Table screen in [Figure 5-8-3](#) appears.

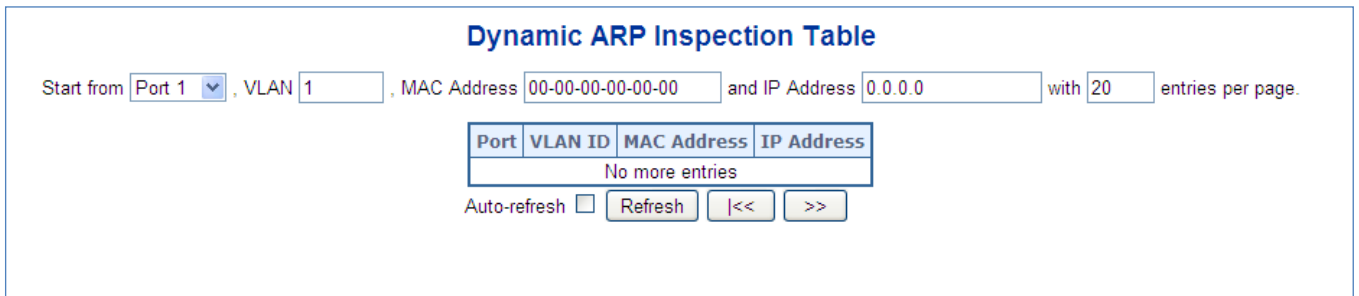

**Figure 5-8-3:** Dynamic ARP Inspection Table Screenshot

**Navigating the ARP Inspection Table**

Each page shows up to 99 entries from the Dynamic ARP Inspection table, default being 20, selected through the "**entries per Page**" input field. When first visited, the web page will show the first 20 entries from the beginning of the Dynamic ARP Inspection Table.

The "**Start from port address**", "**VLAN**", "**MAC address**" and "**IP address**" input fields allow the user to select the starting point in the Dynamic ARP Inspection Table. Clicking the "**Refresh**" button will update the displayed table starting from that or the closest next Dynamic ARP Inspection Table match. In addition, the two input fields will - upon a "**Refresh**" button click - assume the value of the first displayed entry, allowing for continuous refresh with the same start address.

The ">" will use the last entry of the currently displayed as a basis for the next lookup. When the end is reached the text "No more entries" is shown in the displayed table. Use the "<<" button to start over. The page includes the following fields:

Object	Description
• <b>Port</b>	The port number for which the status applies. Click the port number to see the status for this particular port.
• <b>VLAN ID</b>	The VLAN ID of the entry.
• <b>MAC Address</b>	The MAC address of the entry.
• <b>IP Address</b>	The IP address of the entry.

**Buttons**

Auto-refresh  Check this box to refresh the page automatically. Automatic refresh occurs every 3 seconds.

: Refreshes the displayed table starting from the "Start from MAC address" and "VLAN" input fields.

: Flushes all dynamic entries.

: Updates the table starting from the first entry in the MAC Table, i.e. the entry with the lowest VLAN ID and MAC address.

: Updates the table, starting with the entry after the last entry currently displayed.



## 4.6 Ring

### 4.6.1 ERPS Ring

ITU-T G.8032 **Ethernet Ring protection switching (ERPS)** is a link layer protocol applied on Ethernet loop protection to provide sub-50ms protection and recovery switching for Ethernet traffic in a ring topology.

ERPS provides a faster redundant recovery than Spanning Tree topology. The action is similar to STP or RSTP, but the algorithms between them are not the same. In the Ring topology, every switch should be enabled with Ring function and two ports should be assigned as the member ports in the ERPS. Only one switch in the Ring group would be set as the RPL owner switch that one port would be blocked, called **owner port**, and PRL neighbor switch has one port that one port would be blocked, called **neighbor port** that connect to owner port directly and this link is called the **Ring Protection Link** or **RPL**. Each switch will send ETH-CCM message to check the link status in the ring group. When the failure of network connection occurs, the nodes block the failed link and report the signal failure message, the RPL owner switch will automatically unblocks the PRL to recover from the failure.

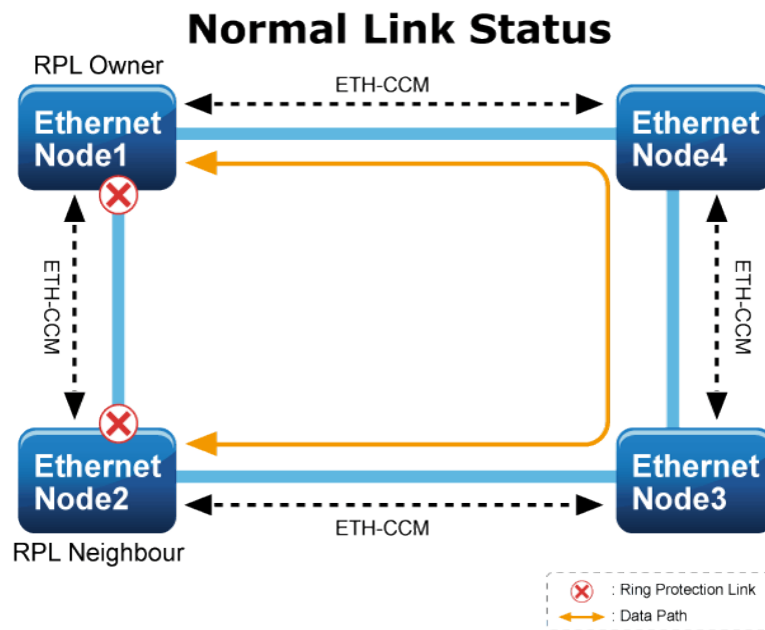

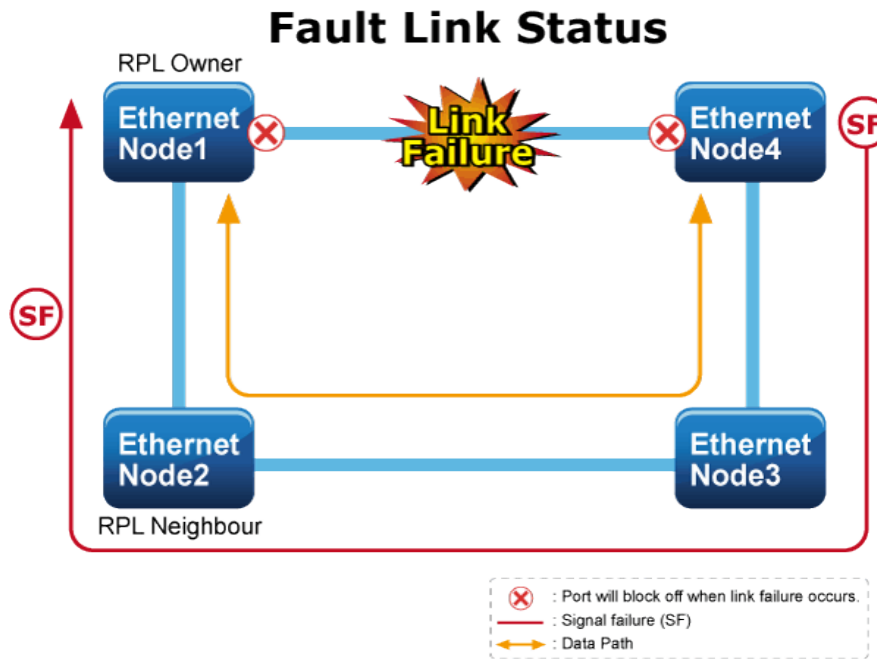

#### 4.6.1.1 MEP Configuration

The **Maintenance Entity Point(MEP)** instances are configured here; screen in [Figure 4-6-1-1](#) appears.

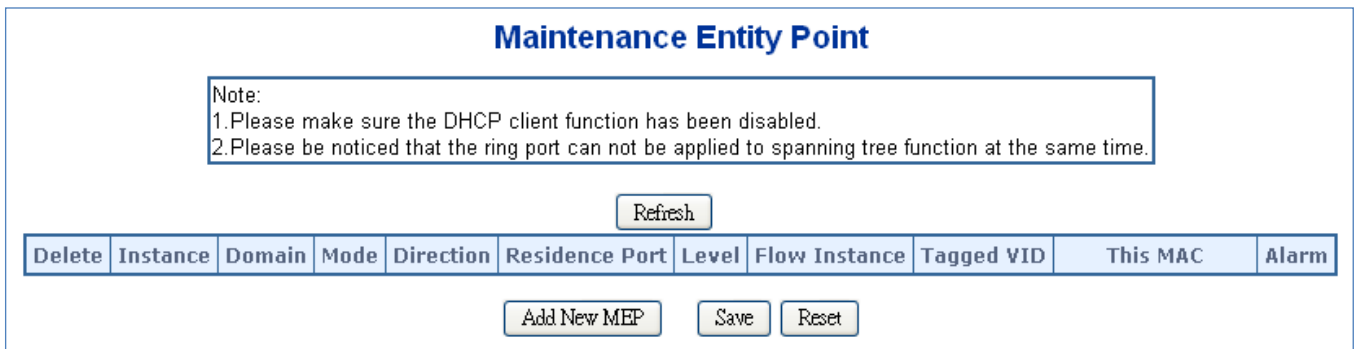

**Figure 4-6-1-1:** MEP configuration page screenshot

The page includes the following fields:

Object	Description
• <b>Delete</b>	This box is used to mark a MEP for deletion in next Save operation.
• <b>Instance</b>	The ID of the MEP. Click on the ID of a MEP to enter the configuration page.
• <b>Domain</b>	<b>Port:</b> This is a MEP in the Port Domain. 'Flow Instance' is a Port. <b>Esp:</b> Future use <b>Evc:</b> This is a MEP in the EVC Domain. 'Flow Instance' is a EVC <b>Mpls:</b> Future use
• <b>Mode</b>	<b>MEP:</b> This is a Maintenance Entity End Point. <b>MIP:</b> This is a Maintenance Entity Intermediate Point.
• <b>Direction</b>	<b>Ingress:</b> This is a Ingress (down) MEP - monitoring ingress traffic on 'Residence

	Port'. <b>Egress:</b> This is a Egress (up) MEP - monitoring egress traffic on 'Residence Port'.
• <b>Residence Port</b>	The port where MEP is monitoring - see 'Direction'.
• <b>Level</b>	The MEG level of this MEP.
• <b>Flow Instance</b>	The MEP is related to this flow - See 'Domain'.
• <b>Tagged VID</b>	<b>Port MEP:</b> An outer C/S-tag (depending on VLAN Port Type) is added with this VID. Entering '0' means no TAG added.
• <b>This MAC</b>	The MAC of this MEP - can be used by other MEP when unicast is selected (Info only).
• <b>Alarm</b>	There is an active alarm on the MEP.

**Buttons**

**Add New MEP**: Click to add a new MEP entry

**Refresh**: Click to refresh the page immediately.

**Save**: Click to save changes.

**Reset**: Click to undo any changes made locally and revert to previously saved values.

### 4.6.1.2 Detailed MEP Configuration

This page allows the user to inspect and configure the current MEP Instance.; screen in [Figure 4-6-1-2](#) appears.

#### MEP Configuration

#### Instance Data

Instance	Domain	Mode	Direction	Residence Port	Flow Instance	Tagged VID	EPS Instance	This MAC
1	Port	Mep	Down	1	1	0	0	00-01-C1-00-00-01

#### Instance Configuration

Level	Format	Domain Name	MEG ID	MEP ID	Tagged VID	cLevel	cMEG	cMEP	cAIS	cLCK	cSSF	aBLK	aTSF
0	ITU ICC		ICC000MEG0000	1	0	<input checked="" type="checkbox"/>	<input checked="" type="checkbox"/>	<input checked="" type="checkbox"/>	<input checked="" type="checkbox"/>	<input checked="" type="checkbox"/>	<input checked="" type="checkbox"/>	<input checked="" type="checkbox"/>	<input checked="" type="checkbox"/>

#### Peer MEP Configuration

Delete	Peer MEP ID	Unicast Peer MAC	cLOC	cRDI	cPeriod	cPriority
No Peer MEP Added						

#### Functional Configuration

Continuity Check				APS Protocol				
Enable	Priority	Frame rate	TLV	Enable	Priority	Cast	Type	Last Octet
<input checked="" type="checkbox"/>	0	1 f/sec	<input type="checkbox"/>	<input checked="" type="checkbox"/>	0	Multi	R-APS	1

#### TLV Configuration

Organization Specific TLV (Global)				
OUI First	OUI Second	OUI Third	Sub-Type	Value
0	0	12	1	2

#### TLV Status

Peer MEP ID	CC Organization Specific						CC Port Status		CC Interface Status	
	OUI First	OUI Second	OUI Third	Sub-Type	Value	Last RX	Value	Last RX	Value	Last RX
4	0	0	0	0	0		0		0	

#### Link State Tracking

Figure 4-6-1-2: Detail MEP configuration page screenshot

The page includes the following fields:

#### Instance Data:

Object	Description
• Instance	The ID of the MEP.
• Domain	See help on MEP create WEB.

• <b>Mode</b>	See help on MEP create WEB.
• <b>Direction</b>	See help on MEP create WEB.
• <b>Residence Port</b>	See help on MEP create WEB.
• <b>Flow Instance</b>	See help on MEP create WEB.
• <b>Tagged VID</b>	See help on MEP create WEB.
• <b>This MAC</b>	See help on MEP create WEB.

**Instance Configuration:**

<b>Object</b>	<b>Description</b>
• <b>Level</b>	See help on MEP create WEB.
• <b>Format</b>	<p>This is the configuration of the two possible Maintenance Association Identifier formats.</p> <ul style="list-style-type: none"> <li>■ <b>ITU ICC:</b> This is defined by ITU (Y1731 Fig. A3). 'Domain Name' is not used. 'MEG id' must be max. 13 char.</li> <li>■ <b>IEEE String:</b> This is defined by IEEE (802.1ag Section 21.6.5). 'Domain Name' can be max. 16 char. 'MEG id' (Short MA Name) can be max. 16 char.</li> <li>■ <b>ITU CC ICC:</b> This is defined by ITU (Y1731 Fig. A5). 'Domain Name' is not used. 'MEG id' must be max. 15 char.</li> </ul>
• <b>Domain Name</b>	This is the IEEE Maintenance Domain Name and is only used in case of 'IEEE String' format. This string can be empty giving Maintenance Domain Name Format 1 - Not present. This can be max 16 char.
• <b>MEG Id</b>	<p>This is either ITU MEG ID or IEEE Short MA Name - depending on 'Format'. See 'Format'. In case of ITU ICC format this must be 13 char. In case of ITU CC ICC format this must be 15 char.</p> <p>In case of IEEE String format this can be max 16 char.</p>
• <b>MEP Id</b>	This value will become the transmitted two byte CCM MEP ID.
• <b>Tagged VID</b>	This value will be the VID of a TAG added to the OAM PDU.
• <b>cLevel</b>	Fault Cause indicating that a CCM is received with a lower level than the configured for this MEP.
• <b>cMEG</b>	Fault Cause indicating that a CCM is received with a MEG ID different from configured for this MEP.
• <b>cMEP</b>	Fault Cause indicating that a CCM is received with a MEP ID different from all 'Peer MEP ID' configured for this MEP.
• <b>cAIS</b>	Fault Cause indicating that AIS PDU is received.

• <b>cLCK</b>	Fault Cause indicating that LCK PDU is received.
• <b>cSSF</b>	Fault Cause indicating that server layer is indicating Signal Fail.
• <b>aBLK</b>	The consequent action of blocking service frames in this flow is active.
• <b>aTSF</b>	The consequent action of indicating Trail Signal Fail to-wards protection is active.

**Peep MEP Configuration:**

Object	Description
• <b>Delete</b>	This box is used to mark a Peer MEP for deletion in next Save operation.
• <b>Peer MEP ID</b>	This value will become an expected MEP ID in a received CCM - see 'cMEP'.
• <b>Unicast Peer MAC</b>	This MAC will be used when unicast is selected with this peer MEP. Also this MAC is used to create HW checking of receiving CCM PDU (LOC detection) from this MEP.
• <b>cLOC</b>	Fault Cause indicating that no CCM has been received (in 3,5 periods) - from this peer MEP.
• <b>cRDI</b>	Fault Cause indicating that a CCM is received with Remote Defect Indication - from this peer MEP.
• <b>cPeriod</b>	Fault Cause indicating that a CCM is received with a period different what is configured for this MEP - from this peer MEP.
• <b>cPriority</b>	Fault Cause indicating that a CCM is received with a priority different what is configured for this MEP - from this peer MEP.

**Buttons**

: Click to add a new peer MEP.

Functional Configuration

Continuity Check:

Functional Configuration

Continuity Check				APS Protocol				
Enable	Priority	Frame rate	TLV	Enable	Priority	Cast	Type	Last Octet
<input checked="" type="checkbox"/>	0	1 f/sec ▼	<input type="checkbox"/>	<input checked="" type="checkbox"/>	0	Multi ▼	R-APS ▼	1

Fault Management    Performance Monitoring

Object	Description
<ul style="list-style-type: none"> <li>• <b>Enable</b></li> </ul>	Continuity Check based on transmitting/receiving CCM PDU can be enabled/disabled. The CCM PDU is always transmitted as Multi-cast Class 1.
<ul style="list-style-type: none"> <li>• <b>Priority</b></li> </ul>	The priority to be inserted as PCP bits in TAG (if any). In case of enable of Continuity Check and Loss Measurement both implemented on SW based CCM, 'Priority' has to be the same.
<ul style="list-style-type: none"> <li>• <b>Frame rate</b></li> </ul>	<p>Selecting the frame rate of CCM PDU. This is the inverse of transmission period as described in Y.1731. This value has the following uses:</p> <ul style="list-style-type: none"> <li>* The transmission rate of the CCM PDU.</li> <li>* Fault Cause cLOC is declared if no CCM PDU has been received within 3.5 periods - see 'cLOC'.</li> <li>* Fault Cause cPeriod is declared if a CCM PDU has been received with different period - see 'cPeriod'.</li> </ul> <p>Selecting 300f/sec or 100f/sec will configure HW based CCM (if possible).            Selecting other frame rates will configure SW based CCM. In case of enable of Continuity Check and Loss Measurement both implemented on SW based CCM, 'Frame Rate' has to be the same.</p>

APS Protocol:

Object	Description
<ul style="list-style-type: none"> <li>• <b>Enable</b></li> </ul>	Automatic Protection Switching protocol information transportation based on transmitting/receiving R-APS/L-APS PDU can be enabled/disabled. Must be enabled to support ERPS/ELPS implementing APS. This is only valid with one Peer MEP configured.
<ul style="list-style-type: none"> <li>• <b>Priority</b></li> </ul>	The priority to be inserted as PCP bits in TAG (if any).

<ul style="list-style-type: none"> <li>• <b>Cast</b></li> </ul>	Selection of APS PDU transmitted unicast or multi-cast. The unicast MAC will be taken from the 'Unicast Peer MAC' configuration. Unicast is only valid for L-APS - see 'Type'. The R-APS PDU is always transmitted with multi-cast MAC described in G.8032.
<ul style="list-style-type: none"> <li>• <b>Type</b></li> </ul>	<p><b>R-APS:</b> APS PDU is transmitted as R-APS - this is for ERPS.</p> <p><b>L-APS:</b> APS PDU is transmitted as L-APS - this is for ELPS.</p>
<ul style="list-style-type: none"> <li>• <b>Last Octet</b></li> </ul>	This is the last octet of the transmitted and expected RAPS multi-cast MAC. In G.8031 (03/2010) a RAPS multi-cast MAC is defined as 01-19-A7-00-00-XX. In current standard the value for this last octet is '01' and the usage of other values is for further study.

**Buttons**

: Click to go to Fault Management page.

: Click to go to Performance Monitor page.

**TLV Configuration:**

Configuration of the OAM PDU TLV. Currently only TLV in the CCM is supported.

### TLV Configuration

Organization Specific TLV (Global)				
OUI First	OUI Second	OUI Third	Sub-Type	Value
0	0	12	1	2

### TLV Status

Peer MEP ID	CC Organization Specific						CC Port Status		CC Interface Status	
	OUI First	OUI Second	OUI Third	Sub-Type	Value	Last RX	Value	Last RX	Value	Last RX
4	0	0	0	0	0	<span style="color: red;">●</span>	0	<span style="color: red;">●</span>	0	<span style="color: red;">●</span>

### Link State Tracking

Organization Specific TLV(Global)

Object	Description
• <b>OUI First</b>	The transmitted first value in the OS TLV OUI field.
• <b>OUI Second</b>	The transmitted second value in the OS TLV OUI field.
• <b>OUI Third</b>	The transmitted third value in the OS TLV OUI field.
• <b>Sub-Type</b>	he transmitted value in the OS TLV Sub-Type field.



• Value	The transmitted value in the OS TLV Value field.
---------	--

**TLV Status:**

Display of the last received TLV. Currently only TLV in the CCM is supported.

Object	Description
• OUI First	The last received first value in the OUI field.
• OUI Second	The last received second value in the OS TLV OUI field.
• OUI Third	The last received third value in the OS TLV OUI field.
• Sub-Type	The last received value in the OS TLV Sub-Type field.
• Value	The last received value in the OS TLV Value field.
• Last RX	OS TLV was received in the last received CCM PDU.
• CC Port Status - Value	The last received value in the PS TLV Value field.
• CC Port Status - Last RX	PS TLV was received in the last received CCM PDU.
• CC Interface Status - Value	The last received value in the IS TLV Value field.
• CC Interface Status - Last RX	IS TLV was received in the last received CCM PDU.
• Link State Tracking • Enable	When LST is enabled in an instance, Local SF or received 'isDown' in CCM Interface Status TLV, will bring down the residence port.  Only valid in Up-MEP. The CCM rate must be 1 f/s or faster.

: Click to refresh the page immediately.

: Click to save changes.

: Click to undo any changes made locally and revert to previously saved values.

### 4.6.1.3 Ethernet Ring Protocol Switch

The Ethernet Ring Protection Switch instances are configured here; screen in [Figure 4-6-1-3](#) appears.

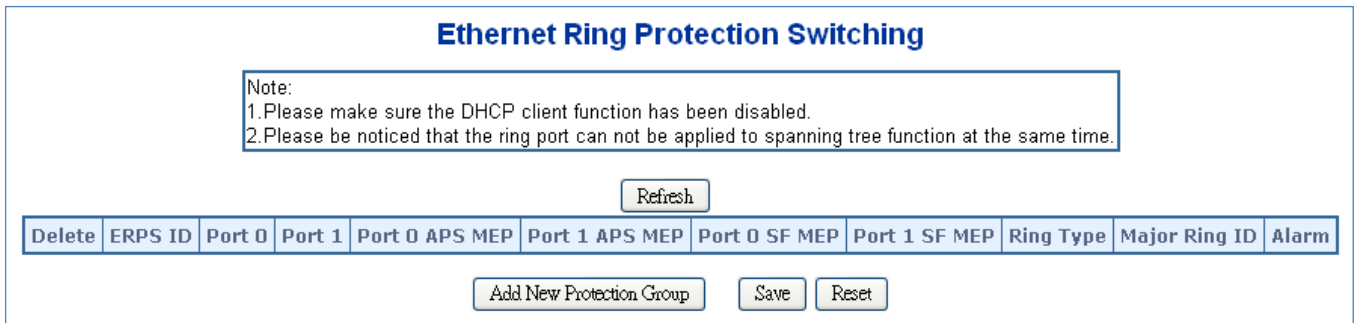

**Figure 4-6-1-3:** Ethernet Ring Protocol Switch page screenshot

The page includes the following fields:

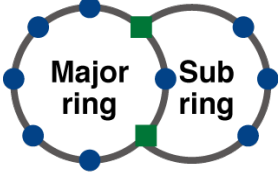
Object	Description
• <b>Delete</b>	This box is used to mark an ERPS for deletion in next Save operation.
• <b>Port 0</b>	This will create a Port 0 of the switch in the ring.
• <b>Port 1</b>	This will create "Port 1" of the switch in the Ring. As interconnected sub-ring will have only one ring port, "Port 1" is configured as "0" for interconnected sub-ring. "0" in this field indicates that no "Port 1" is associated with this instance
• <b>Port 0 SF MEP</b>	The Port 0 Signal Fail reporting MEP.
• <b>Port 1 SF MEP</b>	The Port 1 Signal Fail reporting MEP. As only one SF MEP is associated with interconnected sub-ring without virtual channel, it is configured as "0" for such ring instances. "0" in this field indicates that no Port 1 SF MEP is associated with this instance.
• <b>Port 0 APS MEP</b>	The Port 0 APS PDU handling MEP.
• <b>Port 1 APS MEP</b>	The Port 1 APS PDU handling MEP. As only one APS MEP is associated with interconnected sub-ring without virtual channel, it is configured as "0" for such ring instances. "0" in this field indicates that no Port 1 APS MEP is associated with this instance.
• <b>Ring Type</b>	Type of Protecting ring. It can be either <b>major ring</b> or <b>sub-ring</b> .  <div style="display: flex; justify-content: space-around; align-items: center;"> <div style="text-align: center;">  <p><b>Major ring</b></p> <p>Single-ring Network</p> </div> <div style="text-align: center;">  <p><b>Major ring</b>      <b>Sub ring</b></p> <p>Major-ring + Sub-ring Network</p> </div> </div>
• <b>Major Ring ID</b>	Major ring group ID for the interconnected sub-ring. It is used to send topology change updates on major ring. If ring is major, this value is same as the protection group ID of this ring.

---

• Alarm	There is an active alarm on the ERPS.
---------	---------------------------------------

---

**Buttons**

: Click to add a new Protection group entry.



: Click to refresh the page immediately.



: Click to save changes.



: Click to undo any changes made locally and revert to previously saved values.

#### 4.6.1.4 Ethernet Ring Protocol Switch Configuration

This page allows the user to inspect and configure the current ERPS Instance; screen in [Figure 4-6-1-4](#) appears.

**ERPS Configuration 1**

Auto-refresh

**Instance Data**

ERPS ID	Port 0	Port 1	Port 0 SF MEP	Port 1 SF MEP	Port 0 APS MEP	Port 1 APS MEP	Ring Type
1	1	2	1	2	1	2	Major Ring

**Instance Configuration**

Configured	Guard Time	WTR Time	Hold Off Time	Version	Revertive	VLAN config
<span style="color: green;">●</span>	500	1min	0	v2	<input checked="" type="checkbox"/>	VLAN Config

**RPL Configuration**

RPL Role	RPL Port	Clear
None	None	<input type="checkbox"/>

**Instance Command**

Command	Port
None	None

**Instance State**

Protection State	Port 0	Port 1	Transmit APS	Port 0 Receive APS	Port 1 Receive APS	WTR Remaining	RPL Un-blocked	No APS Received	Port 0 Block Status	Port 1 Block Status	FOP Alarm
Protected	SF	SF	SF DNF BPRQ			0	<span style="color: green;">●</span>	<span style="color: red;">●</span>	Blocked	Blocked	<span style="color: green;">●</span>

Figure 4-6-1-4: Ethernet Ring Protocol Switch Configuration page screenshot

The page includes the following fields:

##### Instance Data:

Object	Description
• <b>ERPS ID</b>	The ID of the Protection group.
• <b>Port 0</b>	See help on ERPS create WEB.
• <b>Port 1</b>	See help on ERPS create WEB.
• <b>Port 0 SF MEP</b>	See help on ERPS create WEB.
• <b>Port 1 SF MEP</b>	See help on ERPS create WEB.
• <b>Port 0 APS MEP</b>	See help on ERPS create WEB.
• <b>Port 1 APS MEP</b>	See help on ERPS create WEB.
• <b>Ring Type</b>	Type of Protecting ring. It can be either major ring or sub-ring.

##### Instance Configuration:

Object	Description
• <b>Configuration</b>	<p><b>Red:</b> This ERPS is only created and has not yet been configured - is not active.</p> <p><b>Green:</b> This ERPS is configured - is active.</p>

<ul style="list-style-type: none"> <li>• <b>Guard Time</b></li> </ul>	<p>Guard timeout value to be used to prevent ring nodes from receiving outdated R-APS messages.</p> <p>The period of the guard timer can be configured in 10 ms steps between 10 ms and 2 seconds, with a default value of 500 ms</p>
<ul style="list-style-type: none"> <li>• <b>WTR Time</b></li> </ul>	<p>The Wait To Restore timing value to be used in revertive switching.</p> <p>The period of the WTR time can be configured by the operator in 1 minute steps between 5 and 12 minutes with a default value of 5 minutes.</p>
<ul style="list-style-type: none"> <li>• <b>Hold Off Time</b></li> </ul>	<p>The timing value to be used to make persistent check on Signal Fail before switching.</p> <p>The range of the hold off timer is 0 to 10 seconds in steps of 100 ms</p>
<ul style="list-style-type: none"> <li>• <b>Version</b></li> </ul>	<p>ERPS Protocol Version - v1 or v2</p>
<ul style="list-style-type: none"> <li>• <b>Revertive</b></li> </ul>	<p>In Revertive mode, after the conditions causing a protection switch has cleared, the traffic channel is restored to the working transport entity, i.e., blocked on the RPL.</p> <p>In Non-Revertive mode, the traffic channel continues to use the RPL, if it is not failed, after a protection switch condition has cleared.</p>
<ul style="list-style-type: none"> <li>• <b>VLAN Config</b></li> </ul>	<p>VLAN configuration of the Protection Group. Click on the "VLAN Config" link to configure VLANs for this protection group.</p>



**PRL Configuration:**

Object	Description
<ul style="list-style-type: none"> <li>• <b>PRL Role</b></li> </ul>	<p>It can be either RPL owner or RPL Neighbor.</p>
<ul style="list-style-type: none"> <li>• <b>PRL Port</b></li> </ul>	<p>This allows to select the east port or west port as the RPL block.</p>
<ul style="list-style-type: none"> <li>• <b>Clear</b></li> </ul>	<p>If the owner has to be changed, then the clear check box allows to clear the RPL owner for that ERPS ring.</p>

**Instance Command:**

Object	Description
<ul style="list-style-type: none"> <li>• <b>Command</b></li> </ul>	<p>Administrative command. A port can be administratively configured to be in either manual switch or forced switch state.</p>
<ul style="list-style-type: none"> <li>• <b>Port</b></li> </ul>	<p>Port selection - Port0 or Port1 of the protection Group on which the command is applied.</p>

**Instance State:**

Instance State											
Protection State	Port 0	Port 1	Transmit APS	Port 0 Receive APS	Port 1 Receive APS	WTR Remaining	RPL Un-blocked	No APS Received	Port 0 Block Status	Port 1 Block Status	FOP Alarm
Protected	SF	SF	SF DNF BPRO			0			Blocked	Blocked	

Object	Description
• <b>Protection State</b>	ERPS state according to State Transition Tables in G.8032.
• <b>Port 0</b>	<b>OK:</b> State of East port is ok <b>SF:</b> State of East port is Signal Fail
• <b>Port 1</b>	<b>OK:</b> State of West port is ok <b>SF:</b> State of West port is Signal Fail
• <b>Transmit APS</b>	The transmitted APS according to State Transition Tables in G.8032.
• <b>Port 0 Receive APS</b>	The received APS on Port 0 according to State Transition Tables in G.8032.
• <b>Port 1 Receive APS</b>	The received APS on Port 1 according to State Transition Tables in G.8032.
• <b>WTR Remaining</b>	Remaining WTR timeout in milliseconds.
• <b>RPL Un-blocked</b>	APS is received on the working flow.
• <b>No APS Received</b>	RAPS PDU is not received from the other end.
• <b>Port 0 Block Status</b>	Block status for Port 0 (Both traffic and R-APS block status). R-APS channel is never blocked on sub-rings without virtual channel.
• <b>Port 1 Block Status</b>	Block status for Port 1 (Both traffic and R-APS block status). R-APS channel is never blocked on sub-rings without virtual channel.
• <b>FOP Alarm</b>	Failure of Protocol Defect(FOP) status. If FOP is detected, red LED glows; else green LED glows.

**Buttons**

: Click to save changes.

Auto-refresh  : Check this box to refresh the page automatically. Automatic refresh occurs every 6 seconds.

: Click to refresh the page immediately.

: Click to undo any changes made locally and revert to previously saved values.

### 4.6.1.5 Ethernet Ring Protocol Switch

This page allows the user to configure the ERPS by wizard; screen in [Figure 4-6-1-5](#) appears.

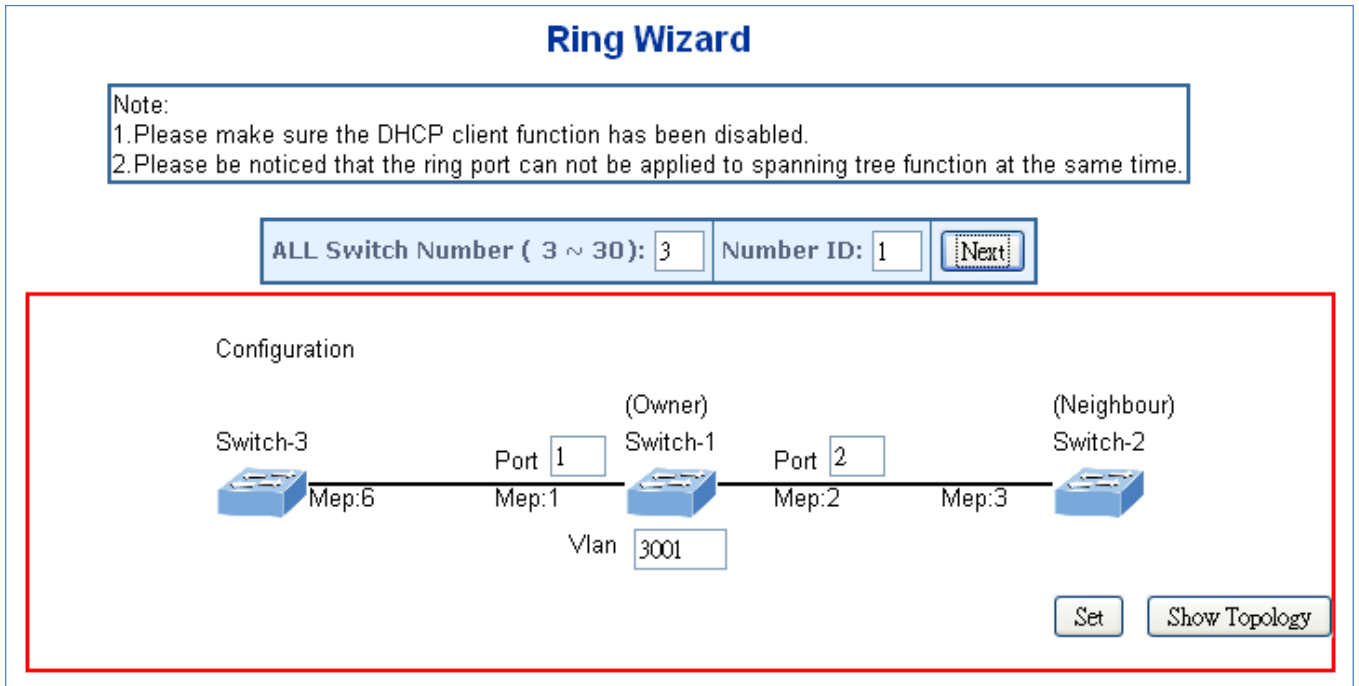



Figure 4-6-1-5: Ring Wizard page screenshot

The page includes the following fields:

Object	Description
<ul style="list-style-type: none"> <li>• <b>All Switch Numbers</b></li> </ul>	Set all the switch numbers for the ring group. The default number is 3 and maximum number is 30.
<ul style="list-style-type: none"> <li>• <b>Number ID</b></li> </ul>	The switch where you are requesting ERPS.
<ul style="list-style-type: none"> <li>• <b>Port</b></li> </ul>	Configures the port number for the MEP.
<ul style="list-style-type: none"> <li>• <b>VLAN</b></li> </ul>	Set the ERPS VLAN.

#### Buttons

: Click to configure ERPS.

: Click to save changes.

: Click to show the ring topology.

#### 4.6.1.6 Ring Wizard Example

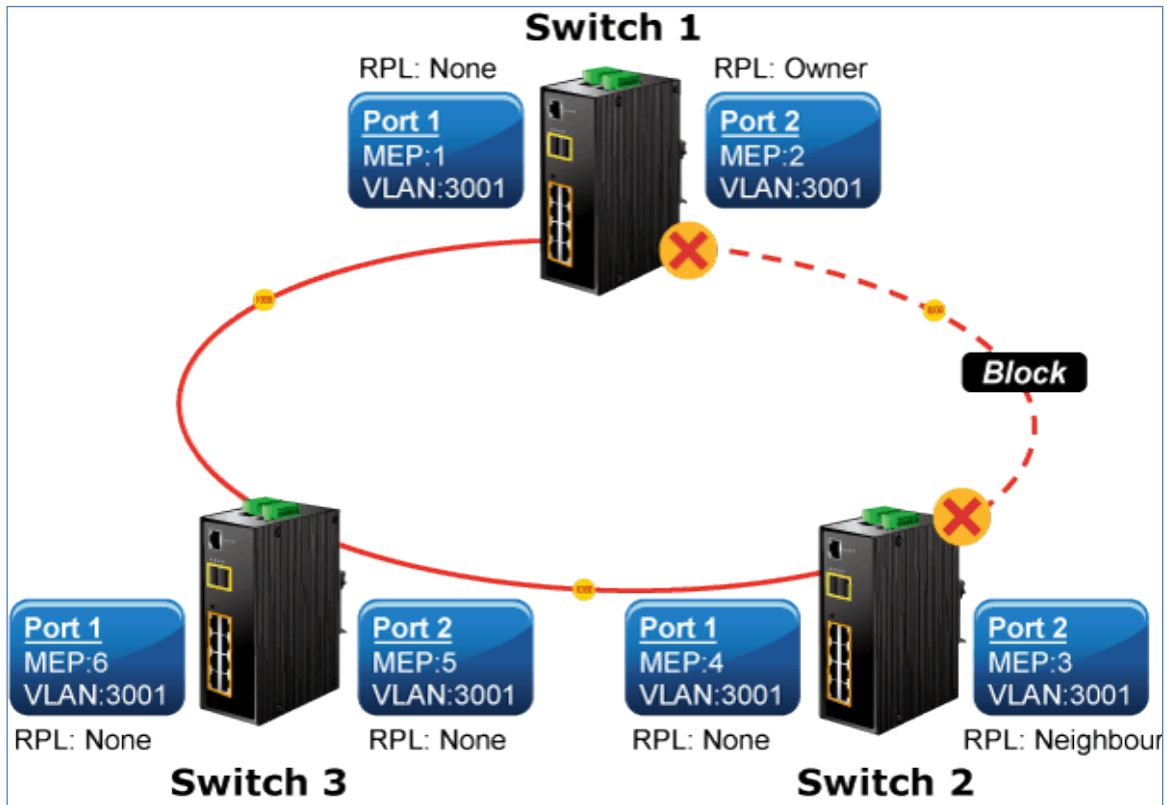

Figure 4-6-1-6: Ring Example Diagram

The above topology often occurs on using ERPS protocol. The multi switch constitutes a single ERPS ring; all of the switches only are configured as an ERPS in VLAN 3001, thereby constituting a single MRPP ring.

Switch ID	Port	MEP ID	RPL Type	VLAN Group
Switch 1	Port 1	1	None	3001
	Port 2	2	<b>Owner</b>	3001
Switch 2	Port 1	4	None	3001
	Port 2	3	<b>Neighbor</b>	3001
Switch 3	Port 1	6	None	3001
	Port 2	5	None	3001

Table 4-6-1-1: ERPS Configuration Table

The scenario described as follows:

1. Disable DHCP client and set proper static IP for Switch 1, 2 & 3. In this example, switch 1 is 192.168.0.101; switch 2 is 192.168.0.102 and switch 3 is 192.168.0.103.
2. On switch 1, 2 & 3, disable spanning tree protocol to avoid confliction with ERPS.



**Setup steps**

**Set ERPS Configuration on Switch 1**

Connect PC to switch 1 directly; don't connect to port 1 & 2

Logging on the Switch 1 and click "Ring > Ring Wizard"

Set "All Switch Number" = 3 and "Number ID" = 1; click "Next" button to set the ERPS configuration for Switch 1.



Set "MEP1" = Port1, "MEP2" = Port2 and VLAN ID = 3001; click "Set" button to save the ERPS configuration for Switch 1.

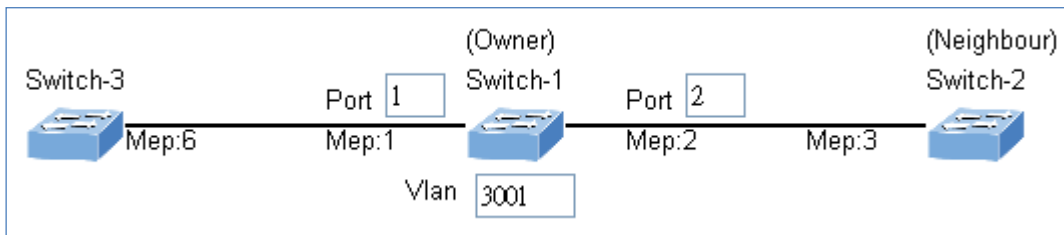

**Set ERPS Configuration on Switch 2**

Connect PC to switch 2 directly; don't connect to port 1 & 2

Logging on the Switch 2 and click "Ring > Ring Wizard"

Set "All Switch Number" = 3 and "Number ID" = 2; click "Next" button to set the ERPS configuration for Switch 2.

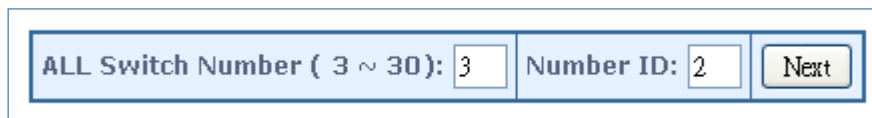

Set "MEP3" = Port2, "MEP4" = Port1 and VLAN ID = 3001; click "Set" button to save the ERPS configuration for Switch 2.

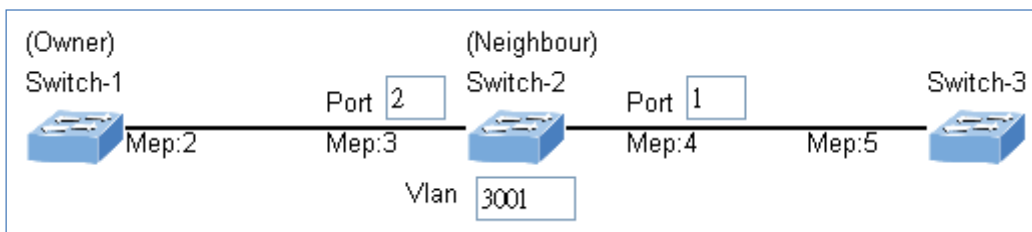

**Set ERPS Configuration on Switch 3**

Connect PC to switch 3 directly; don't connect to port 1 & 2

Logging on the Switch 3 and click "Ring > Ring Wizard"

Set "All Switch Number" = 3 and "Number ID" = 3; click "Next" button to set the ERPS configuration for Switch 3.

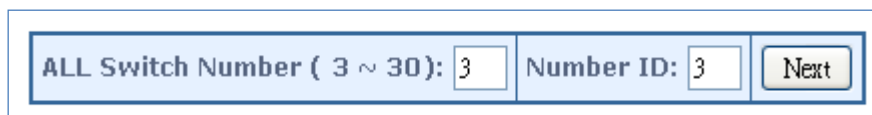

Set "MEP5" = Port2, "MEP6" = Port1 and VLAN ID = 3001; click "Set" button to save the ERPS configuration for Switch 3.

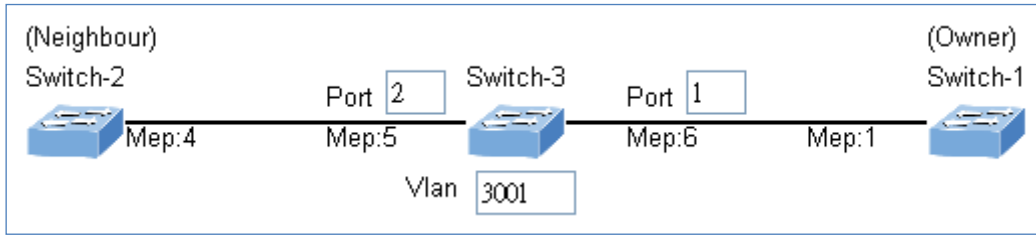

To avoid loop, please don't connect switch 1, 2 & 3 together in the ring topology before configuring the end of ERPS .

**Follow the configuration or ERPS wizard to connect the Switch 1, 2 and 3 together to establish ERPS application:**

MEP2 ↔ MEP3 = Switch1 / Port2 ↔ Switch2 / Port2

MEP4 ↔ MEP5 = Switch2 / Port1 ↔ Switch3 / Port2

MEP1 ↔ MEP6 = Switch1 / Port1 ↔ Switch3 / Port1.

## 4.7 Maintenance

### 4.7.1 Switch Maintenance

This chapter is teaching how to upgrade the firmware, how to save the switch running configure and how to download/upload the configure file and etc.

#### 4.7.1.1 Web Firmware Upgrade

This page facilitates an update of the firmware controlling the switch. The Web Firmware Upgrade screen in [Figure 4-7-1-1](#) appears.



Figure 4-7-1-1: Web Firmware Upgrade Page Screenshot

To open **Firmware Upgrade** screen, perform the following:

1. Click **Maintenance** -> **Web Firmware Upgrade**.
2. The Firmware Upgrade screen is displayed as in [Figure 4-7-1-1](#)
3. Click the "**Choose File**" button of the Main page; the system would pop up the file selection menu to choose firmware.
4. Select on the firmware and then click "**Upload**". The **Software Upload Progress** would show the file with upload status.
5. Once the software is loaded to the system successfully, the following screen appears. The system will load the new software after reboot.

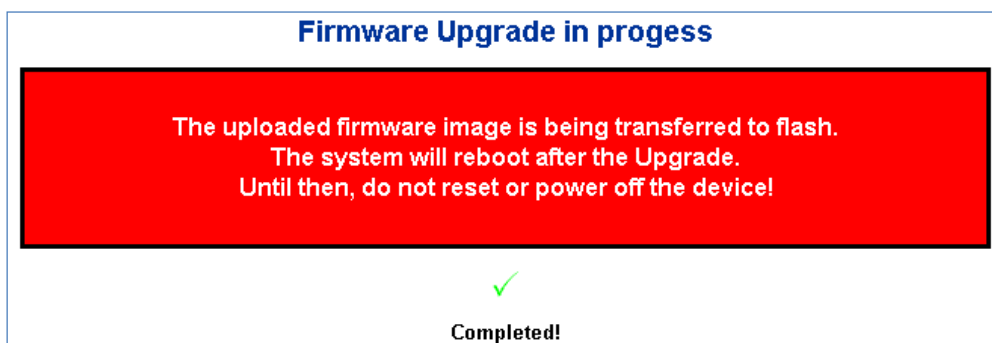

Figure 4-7-1-2: Software Successfully Loaded Notice Screen



**DO NOT Power OFF** the **Industrial Managed Switch** until the update progress is complete.



Do not quit the Firmware Upgrade page without pressing the "OK" button after the image is loaded. Or the system won't apply the new firmware. User has to repeat the firmware upgrade processes.

#### 4.7.1.2 Save Startup Config

This function allows to save the current configuration, thereby ensuring that the current active configuration can be used at the next reboot as the screen in [Figure 4-7-1-3](#) appears. After saving the configuration, the screen in [Figure 4-7-1-4](#) will appear.



Figure 4-7-1-3: Configuration Save Page Screenshot



Figure 4-7-1-4: Finish Saving Page Screenshot

#### 4.7.1.3 Configuration Download

The switch stores its configuration in a number of text files in CLI format. The files are either virtual (RAM-based) or stored in flash on the switch.

There are three system files:

- running-config: A virtual file that represents the currently active configuration on the switch. This file is volatile.
- startup-config: The startup configuration for the switch, read at boot time.
- default-config: A read-only file with vendor-specific configuration. This file is read when the system is restored to default settings.

It is also possible to store up to two other files and apply them to running-config, thereby switching configuration.

Configuration Download page allows the download the running-config, startup-config and default-config on the switch. Please refer to the [Figure 4-7-1-5](#) shown below.

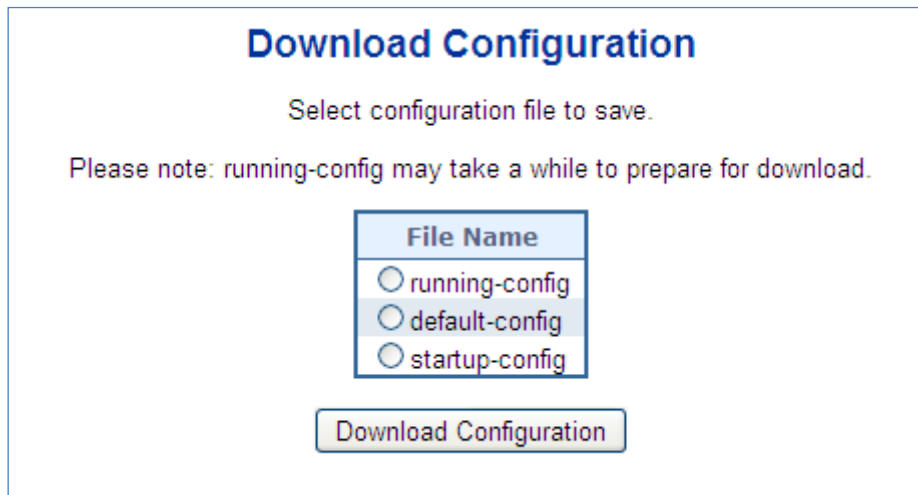

Figure 4-7-1-5: Configuration Download Page Screenshot

#### 4.7.1.4 Configuration Upload

Configuration Upload page allows the upload the running-config and startup-config on the switch. Please refer to the Figure 4-7-1-6 shown below.

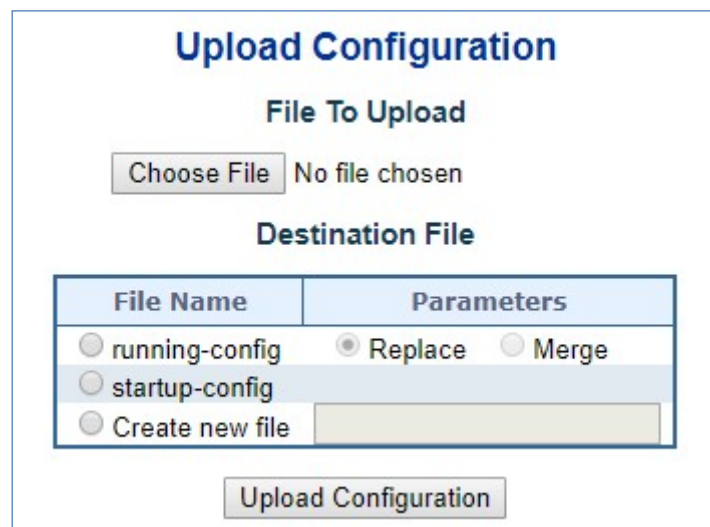

Figure 4-7-1-6: Configuration Upload Page Screenshot

If the destination is running-config, the file will be applied to the switch configuration. This can be done in two ways:

- Replace mode: The current configuration is fully replaced with the configuration in the uploaded file.
- Merge mode: The uploaded file is merged into *running-config*.

If the file system is full (i.e. contains the three system files mentioned above plus two other files), it is not possible to create new files, but an existing file must be overwritten or another deleted first.

#### 4.7.1.5 Configuration Activate

The Configure Activate page allows to activate the startup-config and default-config files present on the switch. Please refer to the Figure 4-7-1-7 shown below.

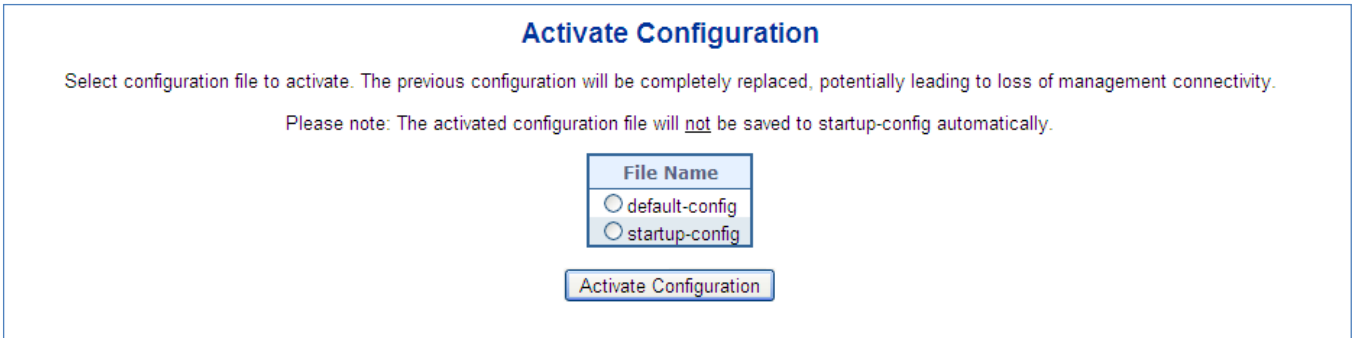



Figure 4-7-1-7: Configuration Activate Page Screenshot

It is possible to activate any of the configuration files present on the switch, except for *running-config* which represents the currently active configuration.

Select the file to activate and click . This will initiate the process of completely replacing the existing configuration with that of the selected file.

#### 4.7.1.6 Configuration Delete

The Configure Delete page allows to delete the startup-config and default-config files which are stored in FLASH. If this is done and the switch is rebooted without a prior Save operation, this effectively resets the switch to default configuration. Please refer to the Figure 4-7-1-8 shown below.

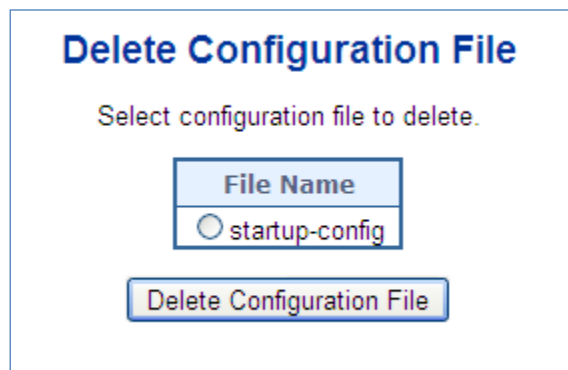

Figure 4-7-1-8: Configuration Delete Page Screenshot

#### 4.7.1.7 Image Select

This page provides information about the active and alternate (backup) firmware images in the device, and allows you to revert to the alternate image. The web page displays two tables with information about the active and alternate firmware images. The Image Select screen in [Figure 4-7-1-9](#) appears.



In case the active firmware image is the alternate image, only the "Active Image" table is shown. In this case, the Activate Alternate Image button is also disabled.



1. If the alternate image is active (due to a corruption of the primary image or by manual intervention), uploading a new firmware image to the device will automatically use the primary image slot and activate this.
2. The firmware version and date information may be empty for older firmware releases. This does not constitute an error.

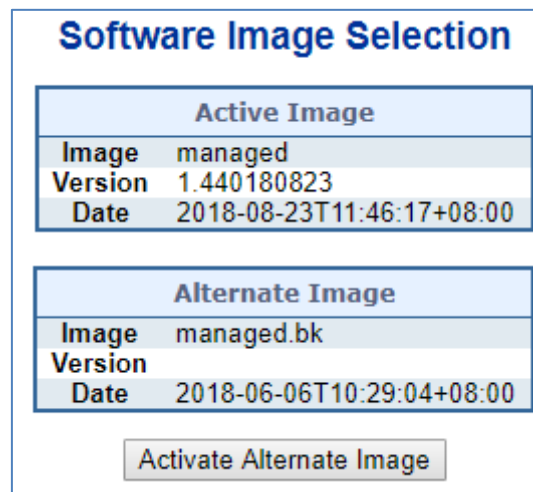
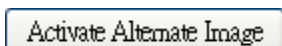

Figure 4-7-1-9: Software Image Selection Page Screenshot

The page includes the following fields:

Object	Description
• <b>Image</b>	The flash index name of the firmware image. The name of primary (preferred) image is image, the alternate image is named image.bk.
• <b>Version</b>	The version of the firmware image.
• <b>Date</b>	The date when the firmware was produced.

#### Buttons



: Click to use the alternate image. This button may be disabled depending on system state.

### 4.7.1.8 Factory Default

You can reset the configuration of the **Industrial Managed Switch** on this page. Only the IP configuration is retained. The new configuration is available immediately, which means that no restart is necessary. The Factory Default screen in [Figure 4-7-1-10](#) appears.

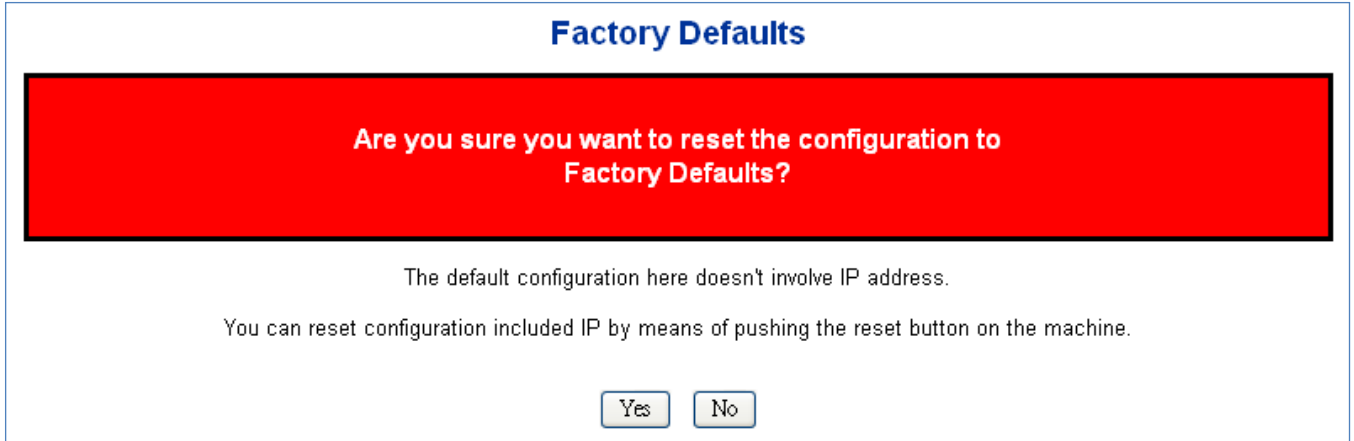

Figure 4-7-1-10: Factory Default Page Screenshot

#### Buttons

: Click to reset the configuration to Factory Defaults.

: Click to return to the Port State page without resetting the configuration.



To reset the **Industrial Managed Switch** to the Factory default setting, you can also press the hardware reset button at the front panel about 10 seconds. After the device is rebooted, you can login the management Web interface within the same subnet of 192.168.0.xx.

### 4.7.1.9 System Reboot

The **Reboot** page enables the device to be rebooted from a remote location. Once the Reboot button is pressed, user has to re-login the Web interface about 60 seconds later; the System Reboot screen in [Figure 4-7-1-11](#) appears.

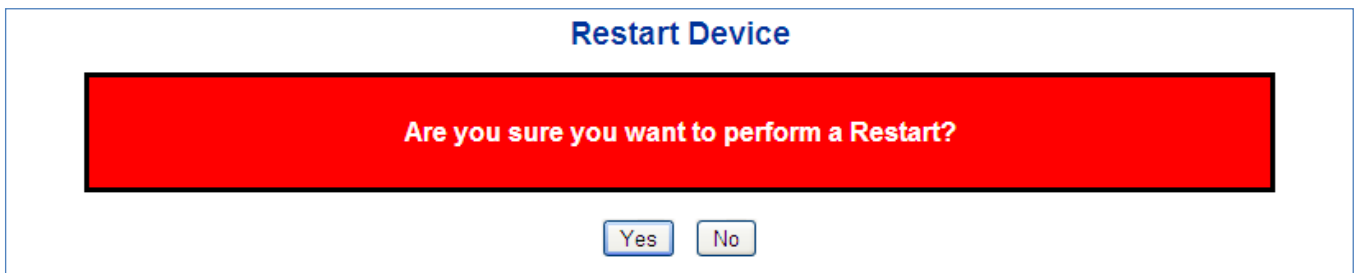



Figure 4-7-1-11: System Reboot Page Screenshot



## Buttons

: Click to reboot the system.

: Click to return to the Port State page without rebooting the system.



You can also check the **SYS LED** on the front panel to identify whether the System is loaded completely or not. If the SYS LED is blinking, then it is in the firmware load stage; if the SYS LED light is on, you can use the Web browser to login the **Industrial Managed Switch**.

## 4.7.2 Diagnostics

This section provide the Physical layer and IP layer network diagnostics tools for troubleshoot. The diagnostic tools are designed for network manager to help them quickly diagnose problems between point to point and better service customers.

Use the Diagnostics menu items to display and configure basic administrative details of the Industrial Managed Switch. Under System the following topics are provided to configure and view the system information:

This section has the following items:

- **Ping**
- **IPv6 Ping**
- **Remote IP Ping**
- **Cable Diagnostics**

### Ping

The ping and IPv6 ping allow you to issue ICMP PING packets to troubleshoot IP connectivity issues. The Industrial Managed Switch transmit ICMP packets, and the sequence number and roundtrip time are displayed upon reception of a reply.

### Cable Diagnostics

The Cable Diagnostics performing tests on copper cables. These functions have the ability to identify the cable length and operating conditions, and to isolate a variety of common faults that can occur on the Cat5 twisted-pair cabling. There might be two statuses as follow:

- If the link is established on the twisted-pair interface in 1000BASE-T mode, the Cable Diagnostics can run without disruption of the link or of any data transfer.
- If the link is established in 100BASE-TX or 10BASE-T, the Cable Diagnostics cause the link to drop while the diagnostics are running.

After the diagnostics are finished, the link is reestablished. And the following functions are available.

- Coupling between cable pairs.
- Cable pair termination
- Cable Length

### 4.7.2.1 Ping

This page allows you to issue ICMP PING packets to troubleshoot IP connectivity issues.

After you press “**Start**”, 5 ICMP packets are transmitted, and the sequence number and roundtrip time are displayed upon reception of a reply. The page refreshes automatically until responses to all packets are received, or until a timeout occurs. The ICMP Ping screen in [Figure 4-7-2-1](#) appears.

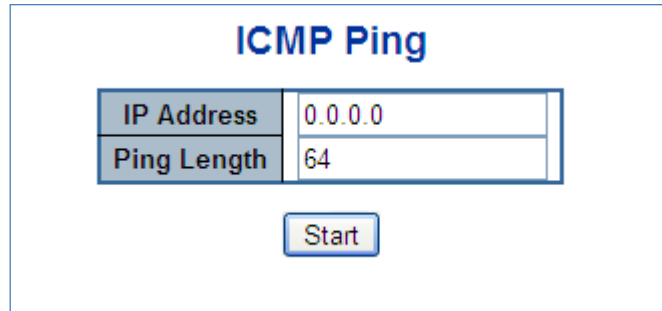

**Figure 4-7-2-1:** ICMP Ping Page Screenshot

The page includes the following fields:

Object	Description
<ul style="list-style-type: none"> <li>• <b>IP Address</b></li> </ul>	The destination IP Address.
<ul style="list-style-type: none"> <li>• <b>Ping Length</b></li> </ul>	The payload size of the ICMP packet. Values range from 2 bytes to 1452 bytes.

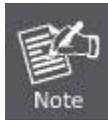

Be sure the target IP Address is within the same network subnet of the **Industrial Managed Switch**, or you had setup the correct gateway IP address.

#### Buttons

: Click to transmit ICMP packets.

: Click to re-start diagnostics with PING.

### 4.7.2.2 IPv6 Ping

This page allows you to issue ICMPv6 PING packets to troubleshoot IPv6 connectivity issues.

After you press “**Start**”, 5 ICMPv6 packets are transmitted, and the sequence number and roundtrip time are displayed upon reception of a reply. The page refreshes automatically until responses to all packets are received, or until a timeout occurs. The ICMPv6 Ping screen in [Figure 4-7-2-2](#) appears.



**Figure 4-7-2-2: ICMPv6 Ping Page Screenshot**

The page includes the following fields:

Object	Description
<ul style="list-style-type: none"> <li>• <b>IP Address</b></li> </ul>	The destination IP Address.
<ul style="list-style-type: none"> <li>• <b>Ping Length</b></li> </ul>	The payload size of the ICMP packet. Values range from 2 bytes to 1452 bytes.

#### Buttons

: Click to transmit ICMP packets.

: Click to re-start diagnostics with PING.

### 4.7.2.3 Remote IP Ping Test

This page allows you to issue ICMP PING packets to troubleshoot IP connectivity issues on special port.

After you press "Test", 5 ICMP packets are transmitted, and the sequence number and roundtrip time are displayed upon reception of a reply. The page refreshes automatically until responses to all packets are received, or until a timeout occurs. The ICMP Ping screen in [Figure 4-7-2-3](#) appears.

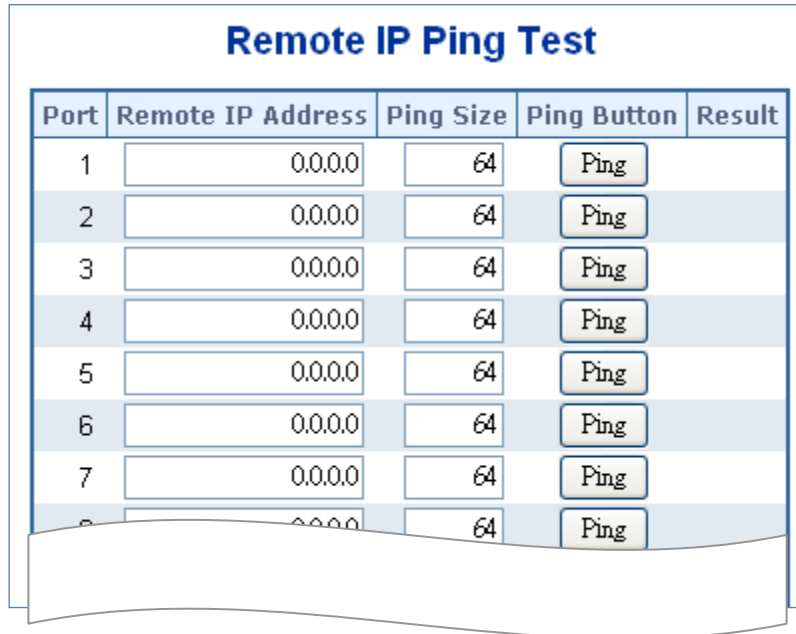



Figure 4-7-2-3: Remote IP Ping Test Page Screenshot

The page includes the following fields:

Object	Description
• Port	The logical port for the settings.
• Remote IP Address	The destination IP Address.
• Ping Size	The payload size of the ICMP packet. Values range from 8 bytes to 1400 bytes.
• Result	Display the ping result.

#### Buttons

 : Click to apply changes

 : Click to undo any changes made locally and revert to previously saved values.

 : Clears the IP Address and the result of ping value.

#### 4.7.2.4 Cable Diagnostics

This page is used for running the Cable Diagnostics.

Press to run the diagnostics. This will take approximately 5 seconds. If all ports are selected, this can take approximately 15 seconds. When completed, the page refreshes automatically, and you can view the cable diagnostics results in the cable status table. Note that Cable Diagnostics is only accurate for cables of length 7 - 140 meters.

10 and 100 Mbps ports will be linked down while running cable diagnostic. Therefore, running cable diagnostic on a 10 or 100 Mbps management port will cause the switch to stop responding until VeriPHY is complete. The VeriPHY Cable Diagnostics screen in [Figure 4-7-2-4](#) appears.

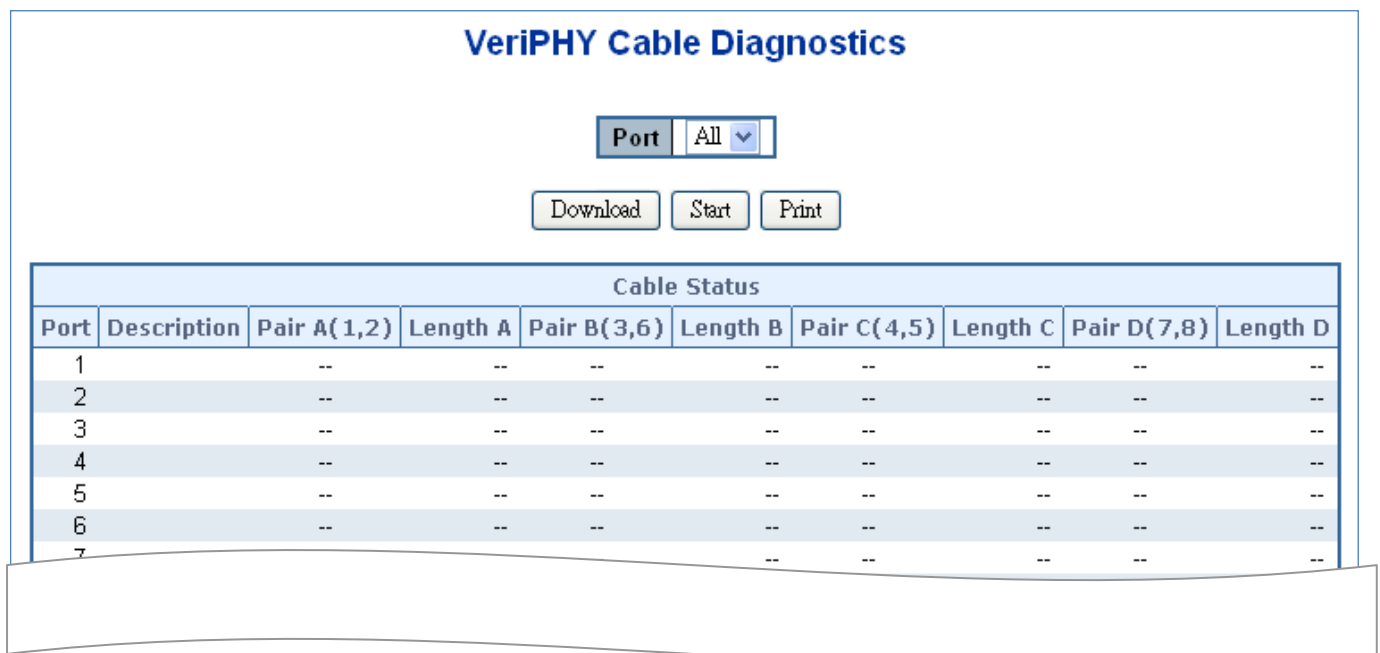

Figure 4-7-2-4 VeriPHY Cable Diagnostics Page Screenshot

The page includes the following fields:

Object	Description
• Port	The port where you are requesting Cable Diagnostics.
• Description	Display per port description.
• Cable Status	<p><b>Port:</b> Port number.</p> <p><b>Pair:</b> The status of the cable pair.</p> <p><b>OK</b> - Correctly terminated pair</p> <p><b>Open</b> - Open pair</p>

---

	<p><b>Short</b> - Shorted pair</p> <p><b>Short A</b> - Cross-pair short to pair A</p> <p><b>Short B</b> - Cross-pair short to pair B</p> <p><b>Short C</b> - Cross-pair short to pair C</p> <p><b>Short D</b> - Cross-pair short to pair D</p> <p><b>Cross A</b> - Abnormal cross-pair coupling with pair A</p> <p><b>Cross B</b> - Abnormal cross-pair coupling with pair B</p> <p><b>Cross C</b> - Abnormal cross-pair coupling with pair C</p> <p><b>Cross D</b> - Abnormal cross-pair coupling with pair D</p> <p><b>Length:</b> The length (in meters) of the cable pair. The resolution is 3 meters</p>
--	---

---

**Buttons**

: Click to run the diagnostics.

## 4.8 Power over Ethernet

### 4.8.1 PoE Switch Introduction

Providing IEEE 802.3at PoE+ or IEEE 802.3bt PoE++ in-line power interfaces, the IGS-6325 PoE Switch Series can easily build a power central-controlled IP phone system, IP Camera system, AP group for the enterprise. For instance, these cameras/APs can be easily installed around the corners of the company for surveillance demands or a wireless roaming environment in the office can be built. Without the power-socket limitation, the IGS-6325 PoE Switch Series makes the installation of cameras or WLAN AP easier and more efficient.

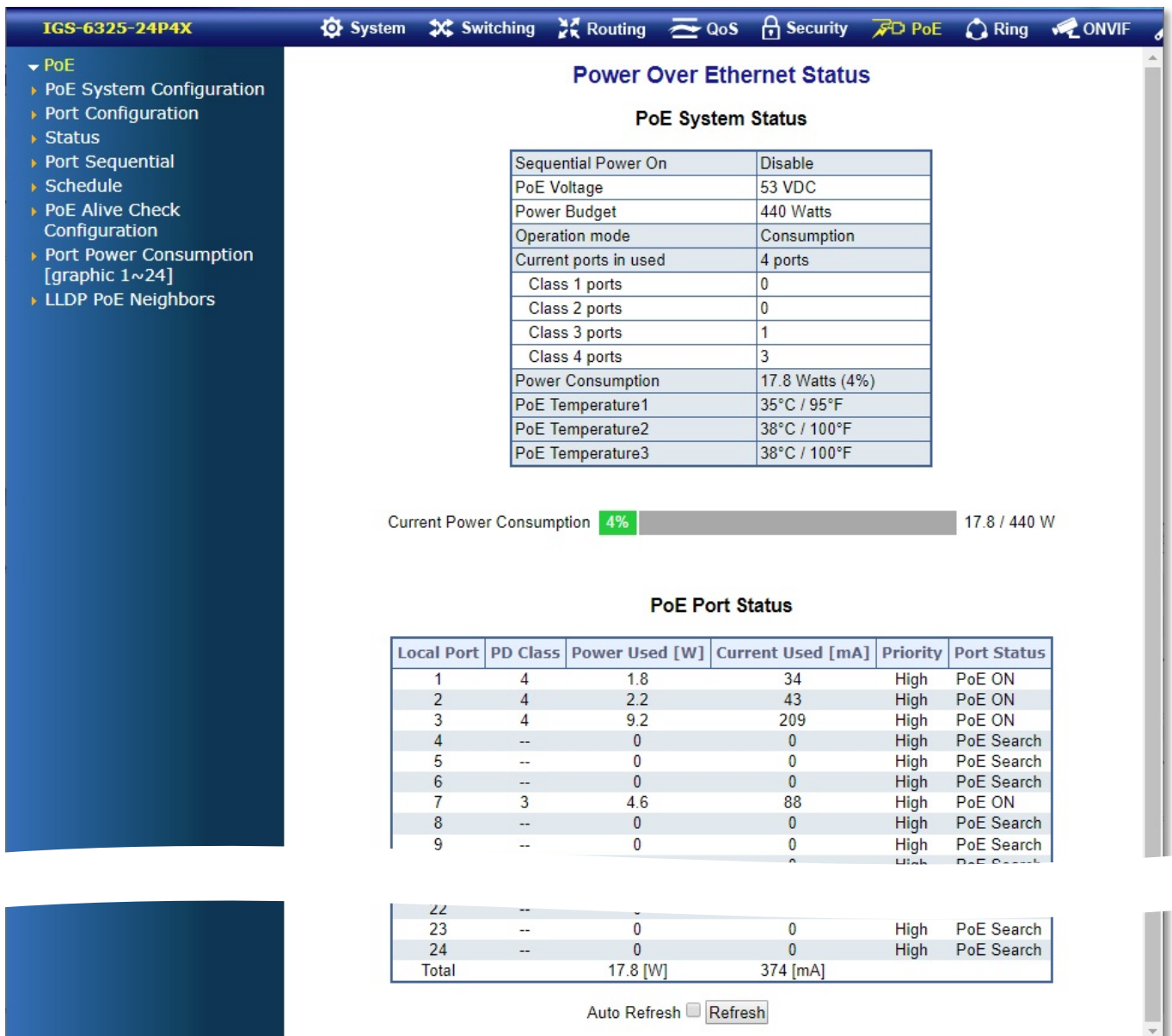







Figure 4-8-1-1: Power over Ethernet Status

## 4.8.2 Power over Ethernet Powered Device

In a power over Ethernet system, operating power is applied from a power source (PSU or -power supply unit) over the LAN infrastructure to **powered devices (PDs)**, which are connected to ports.

 <p><b>3~5 watts</b></p>	<p><b>Voice over IP phones</b></p> <p>Enterprises can install PoE VoIP phones, ATA sand other Ethernet/non-Ethernet end-devices in the center where UPS is installed for un-interruptible power system and power control system.</p>
 <p><b>6~12 watts</b></p>	<p><b>Wireless LAN Access Points</b></p> <p>Access points can be installed at museums, sightseeing sites, airports, hotels, campuses, factories, warehouses, etc.</p>
 <p><b>10~12 watts</b></p>	<p><b>IP Surveillance</b></p> <p>IP cameras can be installed at enterprises, museums, campuses, hospitals, banks, etc. without worrying about electrical outlets.</p>
 <p><b>3~12 watts</b></p>	<p><b>PoE Splitter</b></p> <p>PoE Splitter split the PoE 56V DC over the Ethernet cable into 5/12V DC power output. It frees the device deployment from restrictions due to power outlet locations, which eliminate the costs for additional AC wiring and reduces the installation time.</p>
 <p><b>3~25 watts</b></p>	<p><b>High Power PoE Splitter</b></p> <p>High PoE Splitter split the PoE 56V DC over the Ethernet cable into 24/12V DC power output. It frees the device deployment from restrictions due to power outlet locations, which eliminate the costs for additional AC wiring and reduces the installation time.</p>
 <p><b>30~90 watts</b></p>	<p><b>High Power Speed Dome</b></p> <p>Its state-of-the-art design fits in various network environments like traffic centers, shopping malls, railway stations, warehouses, airports and production facilities for the most demanding outdoor surveillance applications. No electricians are needed to install AC sockets.</p>

### PD Classifications

A PD may be classified by the PSE based on the classification information provided by the PD. The intent of PD classification is to provide information about the maximum power required by the PD during operation. However, to improve power management at the PSE, the PD provides a signature about **Class level**.



The PD is classified based on power. The classification of the PD is the maximum power that the PD will draw across all input voltages and operational modes.

A PD will return to Class 0 to 8 in accordance with the maximum power draw as specified by [Table 4-8-1-1](#).

Class	Usage	Range of maximum power used by the PD	Class Description
0	Default	0.44 to 12.95 watts	Classification unimplement
1	Optional	0.44 to 3.84 watts	Very low power
2	Optional	3.84 to 6.49 watts	Low power
3	Optional	6.49 to 12.95 watts (or to 15.4 watts)	Mid power
4	Valid for Type 2 (802.3at) devices, not allowed for 802.3af devices	12.95 to 25.5 watts	High power
5	Valid for Type 3 (802.3bt) devices	40 watts	
6		51 watts (4-pair)	
7	Valid for Type 4 (802.3bt) devices	62 watts (4-pair)	
8		71.3 watts (4-pair)	

**Table 4-8-1-1 Device Class.**

### 4.8.3 PoE System Configuration

Under some conditions, the total output power required by PDs can exceed the maximum available power provided by the PSU. The system may come with a PSU capable of supplying less power than the total potential power consumption of all the PoE ports in the system. In order to maintain the activity of the majority of ports, **PoE power management** is implemented.

The PSU input power consumption is monitored by measuring voltage and current. The input power consumption is equal to the system's aggregated power consumption. The PoE power management concept allows all ports to be active and activates additional ports, as long as the aggregated power of the system is lower than the power level at which additional PDs cannot be connected. When this value is exceeded, ports will be deactivated, according to user-defined priorities. The power budget is managed according to the following user-definable parameters: **maximum available power, ports priority, maximum allowable power per port.**

#### Reserved Power determined by

There are two modes for configuring how the ports/PDs may reserve power and when to shut down ports.

- **Classification mode**

In this mode each port automatically determines how much power to reserve according to the class the connected PD belongs to, and reserves the power accordingly. Four different port classes exist and one for 4, 7, 15.4 and 30.8 watts.

- **Allocation mode**

In this mode the user allocates the amount of power that each port may reserve. The allocated/reserved power for each port/PD is specified in the Maximum Power fields. The ports are shut down when total reserved powered exceeds the amount of power that the power supply can deliver.



---

In Allocation mode the port power will not be turned on if the PD requests more available power.

---



---

The IEEE 802.3bt PoE++ switches, IGS-6325-8UP2S and IGS-6325-8UP2S2X, support only classification mode.

---

This section allows the user to inspect and configure the current PoE configuration settings, as [Figure 4-8-1-2](#) appears.

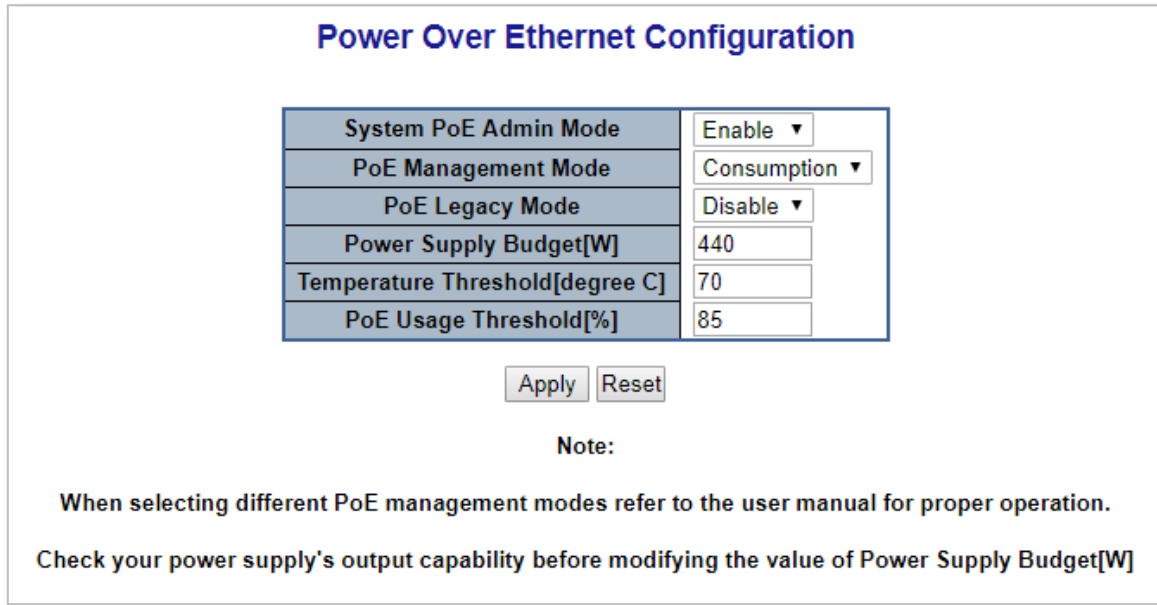



Figure 4-8-1-2: PoE Configuration Screenshot

The page includes the following fields:

Object	Description
<ul style="list-style-type: none"> <li>• <b>System PoE Admin Mode</b></li> </ul>	Allows user to enable or disable PoE function. It will causes all of PoE ports to supply or not supply power.
<ul style="list-style-type: none"> <li>• <b>PoE Temperature Protection</b></li> </ul>	Allows user to enable or disable PoE Temperature Protection.
<ul style="list-style-type: none"> <li>• <b>PoE Management Mode</b></li> </ul>	<p>There are two modes for configuring how the ports/PDs may reserve power and when to shut down ports.</p> <ul style="list-style-type: none"> <li>■ <b>Classification mode:</b> System offers PoE power according to PD real power consumption.</li> <li>■ <b>Allocation mode:</b> Users are allowed to assign how much PoE power for each port and system will reserve PoE power to PD.</li> </ul>
<ul style="list-style-type: none"> <li>• <b>PoE Legacy Mode</b></li> </ul>	In the legacy mode, the IEEE method will be tried first and if it fails to discover a valid PD, the legacy capacitance measurement with a large capacitance value will be used to detect a legacy PD. This mode is used to support legacy devices. The default mode is IEEE mode. Enabled legacy mode could damage non-PD devices.
<ul style="list-style-type: none"> <li>• <b>Power Supply Budget [W]</b></li> </ul>	Set limit value of the total PoE port providing power to the PDs.
<ul style="list-style-type: none"> <li>• <b>Temperature Threshold</b></li> </ul>	This is PoE temperature threshold for user set up a temperature parameter for alarm.
<ul style="list-style-type: none"> <li>• <b>PoE Usage Threshold</b></li> </ul>	This is a parameter for user to define that if PoE power has been consumed to the setting then a alarm log will be issued.

**Buttons**

 : Click to apply changes

 : Click to undo any changes made locally and revert to previously saved values.



Dual power input is required for maximum PoE loading.  
Check your power supply's output capability before modifying the value of Power Supply Budget[W]

---

### 4.8.4 Port Configuration

This section allows the user to inspect and configure the current PoE port settings as [Figure 4-8-1-3](#) shows.

■ **IGS-6325-16P4S 802.3at PoE+ Switch – PoE Port Configuration**

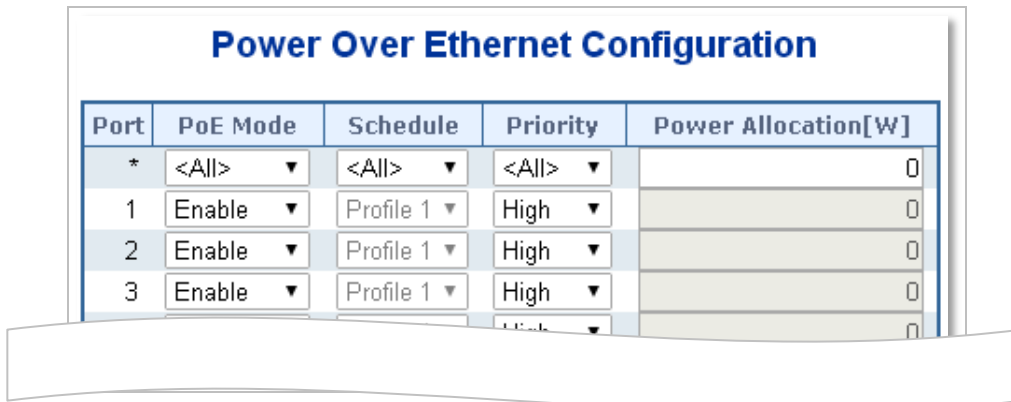

**Figure 4-8-1-3:** Power over Ethernet Configuration Screenshot

The page includes the following fields:

Object	Description
<ul style="list-style-type: none"> <li>• <b>PoE Mode</b></li> </ul>	<p>There are three modes for PoE mode.</p> <ul style="list-style-type: none"> <li>■ <b>Enable</b>: enable PoE function..</li> <li>■ <b>Disable</b>: disable PoE function.</li> <li>■ <b>Schedule</b>: enable PoE function in schedule mode.</li> </ul>
<ul style="list-style-type: none"> <li>• <b>Schedule</b></li> </ul>	<p>Indicates the schedule profile mode. Possible profiles are:</p> <ul style="list-style-type: none"> <li>■ <b>Profile1</b></li> <li>■ <b>Profile2</b></li> <li>■ <b>Profile3</b></li> <li>■ <b>Profile4</b></li> </ul>
<ul style="list-style-type: none"> <li>• <b>Priority</b></li> </ul>	<p>The Priority represents PoE ports priority. There are three levels of power priority named <b>Low</b>, <b>High</b> and <b>Critical</b>.</p> <p>The priority is used in case the total power consumption is over the total power budget. In this case, the port with the lowest priority will be turned off, and power for the port of higher priority will be offered.</p>
<ul style="list-style-type: none"> <li>• <b>Power Allocation</b></li> </ul>	<p>It can limit the port PoE supply wattage. Per port maximum value must be less than <b>36W watts</b>; total ports values must be less than the Power Reservation value. Once power overload is detected, the port will automatically shut down and continue to be in detection mode until Pad's power consumption is lower than the power limit value.</p>

■ **IGS-6325-8UP2S2X** and **IGS-6325-8UP2S** 802.3bt PoE++ Switch – PoE Port Configuration

**802.3bt PoE++ and Advanced PoE Power Output Mode Management**

To meet the demand of various powered devices consuming stable PoE power, the IGS-6325 PoE++ Switch series provides five different PoE power output modes for selection.

- 95W **UPOE/PoH** Power Output Mode (Pins 1, 2, 3, 6 + Pins 4, 5, 7, 8)
- 90W **802.3bt PoE++** Power Output Mode (Pins 1, 2, 3, 6 + Pins 4, 5, 7, 8)
- 60W **Force Power** Output Mode (Pins 1, 2, 3, 6 + Pins 4, 5, 7, 8)
- 30W **End-span PoE** Power Output Mode (Pins 1, 2, 3, 6)
- 30W **Mid-span PoE** Power Output Mode (Pins 4, 5, 7, 8)

This page allows user to set up PoE port attributes.

**Power Over Ethernet Configuration**

Port	PoE Mode	Schedule	PoE Inline Mode	Force Power	Extended Mode	Priority	Power Allocation[W]
*	<All> ▼	<All> ▼	<All> ▼	<All> ▼	<All> ▼	<All> ▼	
1	Enable ▼	Profile 1 ▼	802.3bt ▼	Off ▼	Disable ▼	High ▼	90
2	Enable ▼	Profile 1 ▼	802.3bt ▼	Off ▼	Disable ▼	High ▼	90
3	Enable ▼	Profile 1 ▼	802.3bt ▼	Off ▼	Disable ▼	High ▼	90
4	Enable ▼	Profile 1 ▼	802.3bt ▼	Off ▼	Disable ▼	High ▼	90
5	Enable ▼	Profile 1 ▼	802.3bt ▼	Off ▼	Disable ▼	High ▼	90
6	Enable ▼	Profile 1 ▼	802.3bt ▼	Off ▼	Disable ▼	High ▼	90
7	Enable ▼	Profile 1 ▼	802.3bt ▼	Off ▼	Disable ▼	High ▼	90
8	Enable ▼	Profile 1 ▼	802.3bt ▼	Off ▼	Disable ▼	High ▼	90

Apply Reset

The page includes the following fields:

Object	Description
<ul style="list-style-type: none"> <li>• <b>PoE Mode</b></li> </ul>	<p>There are three modes for PoE mode.</p> <ul style="list-style-type: none"> <li>■ <b>Enable</b>: enable PoE function..</li> <li>■ <b>Disable</b>: disable PoE function.</li> <li>■ <b>Schedule</b>: enable PoE function in schedule mode.</li> </ul>
<ul style="list-style-type: none"> <li>• <b>Schedule</b></li> </ul>	<p>Indicates the schedule profile mode. Possible profiles are:</p> <ul style="list-style-type: none"> <li>■ <b>Profile1</b></li> <li>■ <b>Profile2</b></li> <li>■ <b>Profile3</b></li> <li>■ <b>Profile4</b></li> </ul> <p>To enable this feature, <b>NTP</b> and <b>PoE schedule</b> must be enable first.</p>

<ul style="list-style-type: none"> <li>• <b>PoE Inline Mode</b></li> </ul>	<p>It allows user to select IEEE802.3at/802.3bt/Ultra PoE compatibility mode to meet all PoE PD types for various PoE applications.</p> <p>Setting the Right Power Inline Mode for Each Application:</p> <ul style="list-style-type: none"> <li>■ <b>Midspan</b>: Set inline mode to IEEE 802.3at PoE+ Mid-span PSE. Pins 4-5 (pair #1 in both T568A and T568B) form one side of the DC supply and pins 7-8 (pair #4 in both T568A and T568B) provide the return. Maximum power is <b>36.0 watts</b>.</li> <li>■ <b>Endspan</b>: Set inline mode to IEEE 802.3at PoE+ End-span PSE. Pins 1-2 (pair #2 in both T568A and T568B) form one side of the DC supply and pins 3-6 (pair #3 in both T568A and T568B) provide the return. Maximum power is <b>36.0 watts</b>.</li> <li>■ <b>802.3bt</b>: Set inline mode to IEEE 802.3bt PoE++ Type-4 or Type-3 PSE. Pins 1-2 (pair #2 in both T568A and T568B) form one side of the DC supply and pins 3-6 (pair #3 in both T568A and T568B) provide the return. Pins 4-5 (pair #1 in both T568A and T568B) form one side of the DC supply and pins 7-8 (pair #4 in both T568A and T568B) provide the return. Maximum power is <b>90-60 watts</b>.</li> <li>■ <b>UPOE</b>: Set inline mode to PoH (Power over HD-BASE-T) 4-pair PoE+ PSE Pins 1-2 (pair #2 in both T568A and T568B) form one side of the DC supply and pins 3-6 (pair #3 in both T568A and T568B) provide the return. Pins 4-5 (pair #1 in both T568A and T568B) form one side of the DC supply and pins 7-8 (pair #4 in both T568A and T568B) provide the return Maximum power is 72-60.0 watts</li> </ul>
<ul style="list-style-type: none"> <li>• <b>Force Power</b></li> </ul>	<p>It allows user to enable force power function in a specified PoE Inline mode.</p> <p>Once the force power is enabled, the PoE port will ignore the PoE classification behaviors and directly deliver power over UTP cable no matter what Ethernet device is attached, or even there is no Ethernet cable plugged.</p> <p>Please be careful when using force power function and make sure the remote device is PoE powered device (PD).</p> <p>Maximum power is <b>60 watts</b> when PoE Inline mode is configured to 8023bt or UPOE mode.</p>
<ul style="list-style-type: none"> <li>• <b>PoE Extension</b></li> </ul>	<p>For user to enable or disable per port PoE Extension function.</p>

	<p>Default setting is "Disable".</p> <p>In the Extend operation mode, the PoE port operates at <b>10Mbps duplex</b> operation but can support PoE power output over a distance of up to 160 meters overcoming the 100m limit on Ethernet UTP cable.</p>
<ul style="list-style-type: none"> <li>• <b>Priority</b></li> </ul>	<p>The Priority represents PoE ports priority. There are three levels of power priority named <b>Low, High</b> and <b>Critical</b>.</p> <p>The priority is used in case the total power consumption is over the total power budget. In this case, the port with the lowest priority will be turned off, and power for the port of higher priority will be offered.</p>
<ul style="list-style-type: none"> <li>• <b>Power Allocation</b></li> </ul>	<p>The Powe Allocation column shows per port maximum value of PoE power. Once power overload is detected, the port will automatically shut down and continue to be in detection mode until Pad's power consumption is lower than the power limit value.</p> <ul style="list-style-type: none"> <li>■ <b>95W</b> UPOE/PoH</li> <li>■ <b>90W</b> 802.3bt PoE++</li> <li>■ <b>60W</b> Force Power</li> <li>■ <b>36W</b> End-span PoE</li> <li>■ <b>36W</b> Mid-span PoE</li> </ul>

**PoE Extended Function**

In the "Extended" operation mode, the IGS-6325 series operates on a per-port basis at 10Mbps duplex operation but can support PoE power output over a distance of up to 200 meters overcoming the 100 meters limit on Ethernet UTP cable.

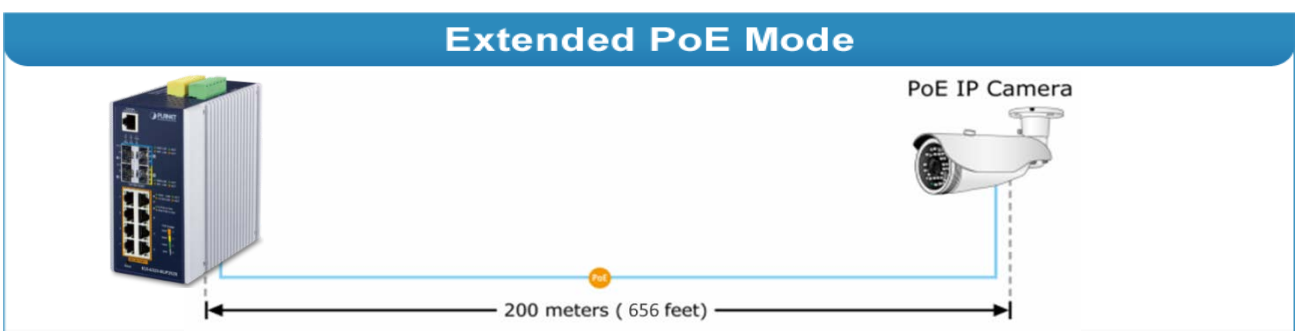
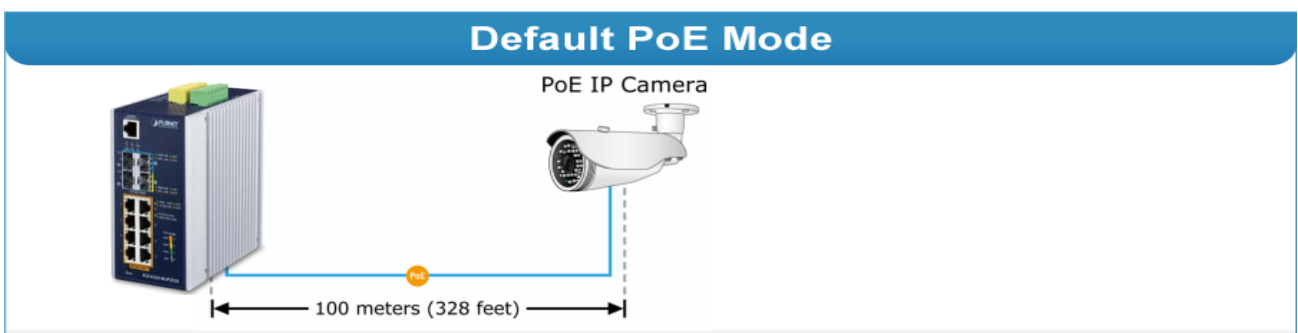



### 4.8.5 PoE Status

This page allows the user to inspect the total power consumption, total power reserved and current status for all PoE ports. The screen in [Figure 4-8-1-4](#) appears.

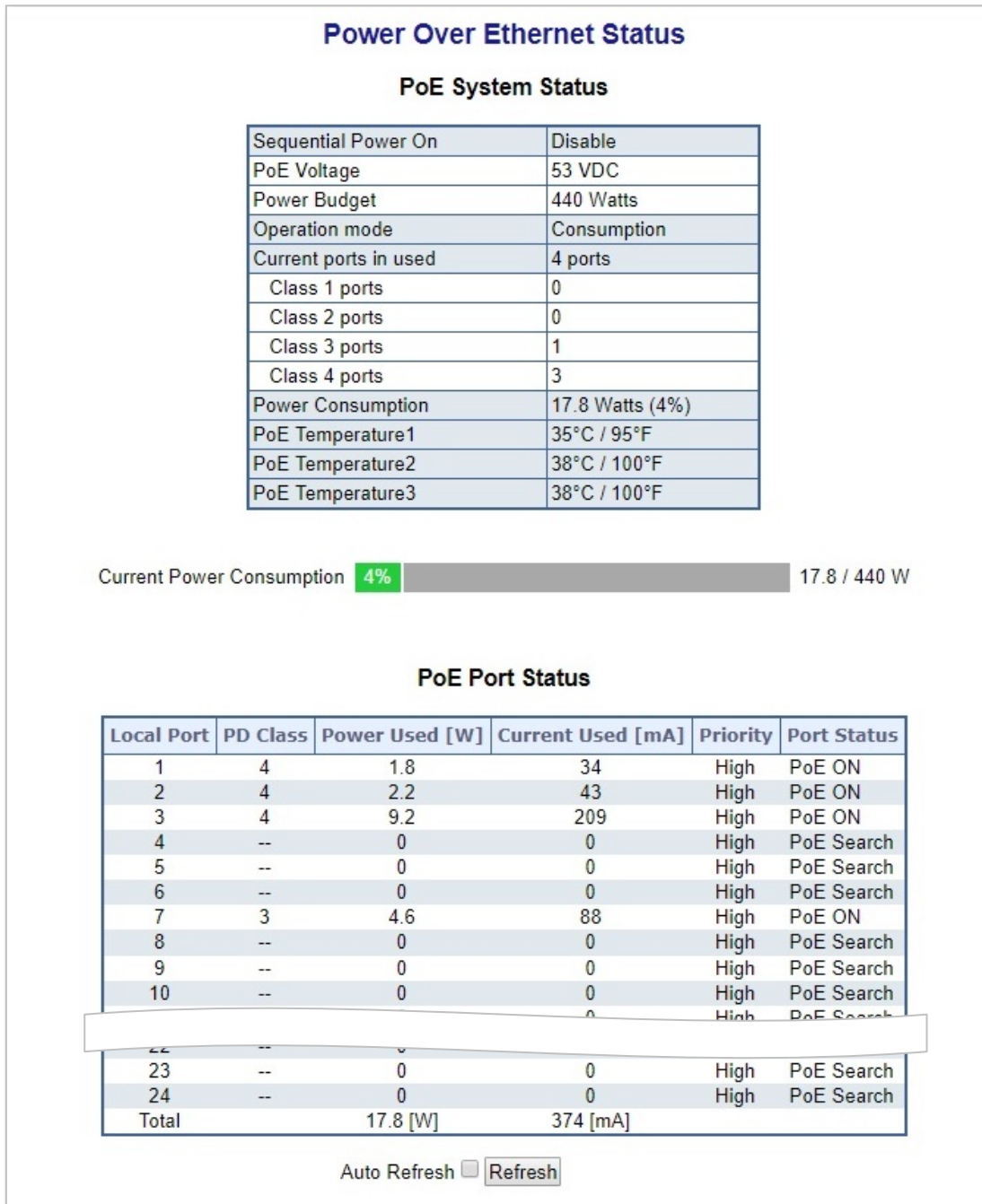

Figure 4-8-1-4:PoE Status Screenshot

The page includes the following fields:

Object	Description
• <b>Sequential Power On</b>	Displays the current sequential power on mode.
• <b>PoE Voltage</b>	Displays the current PoE voltage.

• <b>System Power Budget</b>	Displays the maximum PoE power budget.
• <b>Operation Mode</b>	Displays the current PoE operation mode.
• <b>Current Budget</b>	Displays the current maximum PoE budget.
• <b>Current Ports in Use</b>	Displays the current PoE ports in use.
• <b>Class 1 ~ 8 ports</b>	Displays the current ports of PoE class 1 ~ 8.
• <b>Power Consumption</b>	Displays the current power consumption (total watts and percentage)
• <b>PoE Temperature</b>	Displays the current operating temperature of the first PoE chip unit.
• <b>Current Power Consumption</b>	Shows the total watts usage of Managed PoE Switch.
• <b>Total Power Reserved</b>	Shows how much the total power is reserved for all PDs.
• <b>Temperature</b>	Displays the current operating temperature of the PoE chip unit.
• <b>Local Port</b>	This is the logical port number for this row.
• <b>PD Class</b>	Displays the class of the PD attached to the port, as established by the classification process. Class 0 is the default for PDs. The PD is powered based on PoE Class level if system is working in Classification mode. A PD will return Class to 0 to 4 in accordance with the maximum power draw as specified by <a href="#">Table 4-8-1-1</a> .
• <b>Power Used [W]</b>	The <b>Power Used</b> shows how much power the PD currently is using.
• <b>Current Used [mA]</b>	The <b>Power Used</b> shows how much current the PD currently is using.
• <b>Priority</b>	The <b>Priority</b> shows the port's priority configured by the user.
• <b>Port Status</b>	The <b>Port Status</b> shows the port's status.
• <b>Power Inline Mode</b>	Displays per PoE port operating in mid-span, end-span or UPoE mode.
• <b>Total</b>	Shows the total power and current usage of all PDs.

**Buttons**

Auto-refresh : Check this box to enable an automatic refresh of the page at regular intervals.

: Click to refresh the page immediately.

### 4.8.6 Port Sequential

This page allows the user to configure the PoE Ports started up interval time. The PoE Port will start up one by one as [Figure 4-8-1-5](#) shows.

### Port Sequential Power up Interval

<b>Sequential Power up Option</b>	Enable <input type="button" value="v"/>
<b>Sequential Power up Interval</b>	5 <input type="text"/> (3 ~ 30) seconds
<b>Sequential Power up Port Option</b>	By port <input type="button" value="v"/>

**Figure 4-8-1-5:** PoE Port Sequential Power Up Interval Configuration Screenshot



The PoE port will start up after the whole system program has finished running.

The page includes the following fields:

Object	Description
• <b>Sequential Power up Option</b>	Allows user to enable or disable Sequential Power up function.
• <b>Sequential Power up Interval</b>	Allows user to configure the PoE Port Start Up interval time.
• <b>Sequential Power up Port Option</b>	There are two modes for Starting Up the PoE Port <b>By Port:</b> The PoE Port will start up by following Port number. <b>By Priority:</b> The PoE Port will start up by following the PoE Priority.

#### Buttons



: Click to apply changes



: Click to undo any changes made locally and revert to previously saved values.

### 4.8.7 PoE Schedule

This page allows the user to define PoE schedule and schedule power recycle.

#### PoE Schedule

Besides being used as an IP Surveillance, the Managed PoE switch is certainly applicable to constructing any PoE network including VoIP and Wireless LAN. Under the trend of energy saving worldwide and contributing to the environmental protection on the Earth, the Managed PoE switch can effectively control the power supply besides its capability of giving high watts power.

The **"PoE schedule"** function helps you to enable or disable PoE power feeding for each PoE port during specified time intervals and it is a powerful function to help SMBs or Enterprises save power and budget.

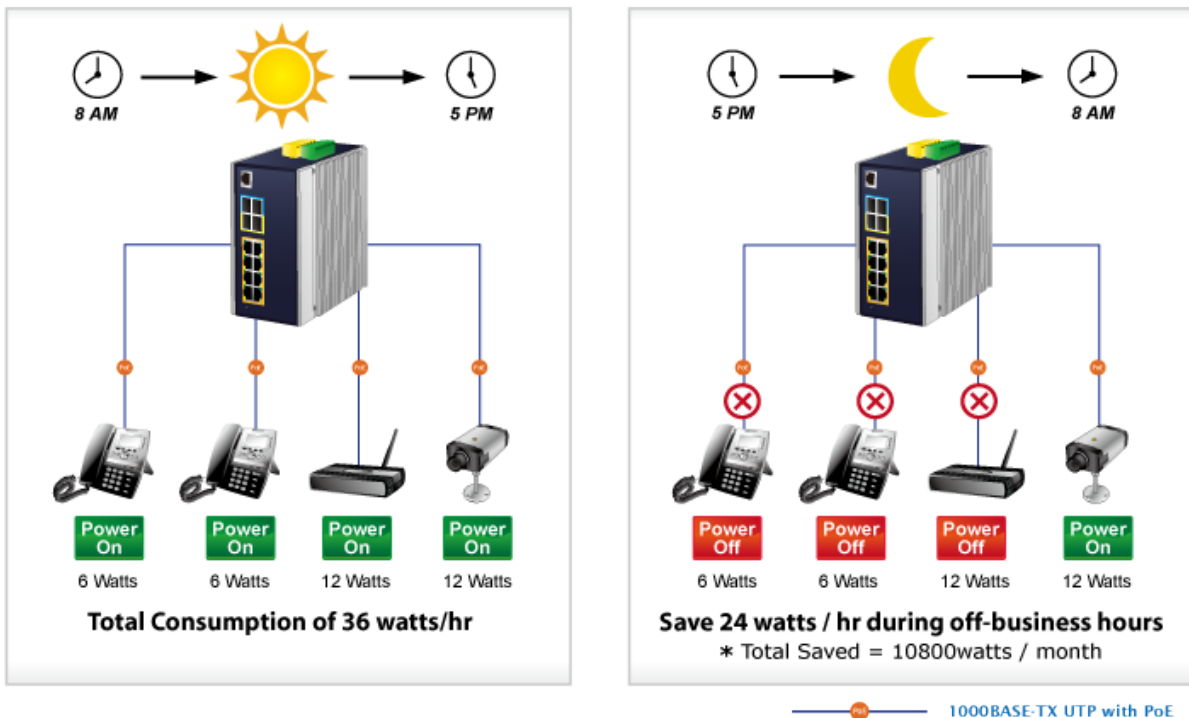

#### Scheduled Power Recycling

The Managed PoE switch allows each of the connected PoE IP cameras to reboot in a specific time each week. Therefore, it will reduce the chance of IP camera crash resulting from buffer overflow. The screen in Figure 4-8-1-6 appears.

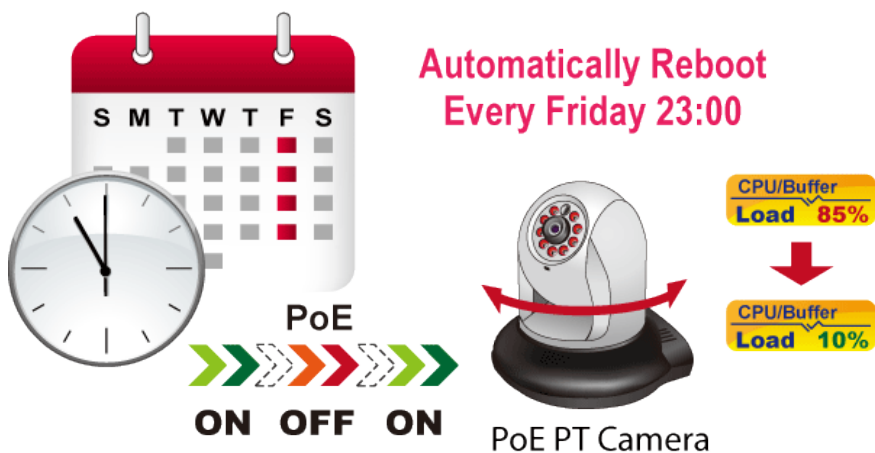

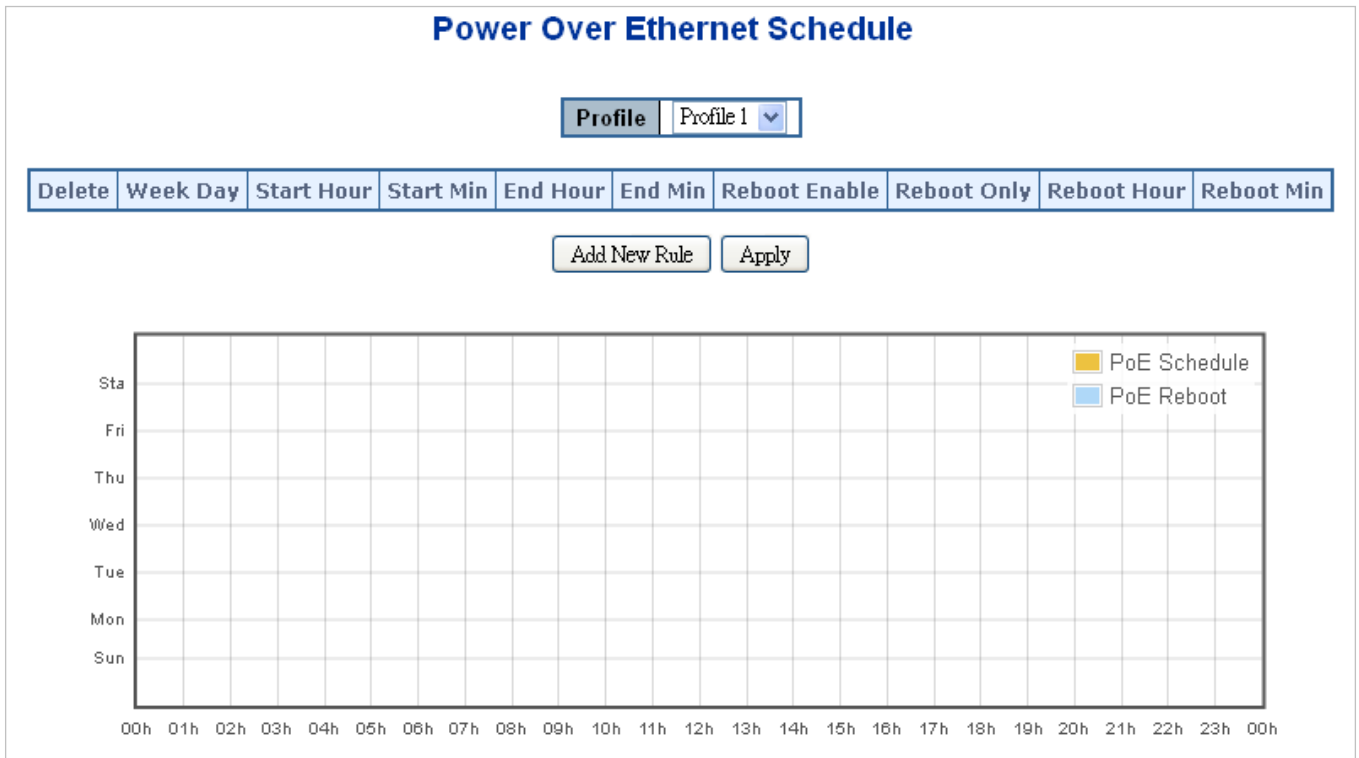

Figure 4-8-1-6: PoE Schedule Screenshot

Please press the **Add New Rule** button to start setting PoE Schedule function. You have to set PoE schedule to profile and then go back to PoE Port Configuration, and select **"Schedule"** mode from per port **"PoE Mode"** option. You can then indicate which schedule profile could be applied to the PoE port.

The page includes the following fields:

Object	Description
<ul style="list-style-type: none"> <li><b>Profile</b></li> </ul>	Set the schedule profile mode. Possible profiles are: <b>Profile1</b> <b>Profile2</b> <b>Profile3</b> <b>Profile4</b>
<ul style="list-style-type: none"> <li><b>Week Day</b></li> </ul>	Allows user to set week day for defining PoE function should be enabled on the day.
<ul style="list-style-type: none"> <li><b>Start Hour</b></li> </ul>	Allows user to set what hour does PoE function enables.
<ul style="list-style-type: none"> <li><b>Start Min</b></li> </ul>	Allows user to set what minute does PoE function enables.
<ul style="list-style-type: none"> <li><b>End Hour</b></li> </ul>	Allows user to set what hour does PoE function disables.
<ul style="list-style-type: none"> <li><b>End Min</b></li> </ul>	Allows user to set what minute does PoE function disables.
<ul style="list-style-type: none"> <li><b>Reboot Enable</b></li> </ul>	Allows user to enable or disable whole PoE port reboot by PoE reboot schedule. Please be noticed that if you want to PoE schedule and PoE reboot schedule work

	<p>at the same time, please use this function, and don't use <b>Reboot Only</b> function.</p> <p>This function offers administrator to reboot PoE device at indicate time if administrator has this kind of requirement.</p>
<ul style="list-style-type: none"> <li>• <b>Reboot Only</b></li> </ul>	<p>Allows user to reboot PoE function by PoE reboot schedule. Please be noticed that if administrator enable this function, PoE schedule will not to set time to profile. This function is just for PoE port reset at an indicated time.</p>
<ul style="list-style-type: none"> <li>• <b>Reboot Hour</b></li> </ul>	<p>Allows user to set what hour PoE reboots. This function only for PoE reboot schedule.</p>
<ul style="list-style-type: none"> <li>• <b>Reboot Min</b></li> </ul>	<p>Allows user to set what minute PoE reboots. This function only for PoE reboot schedule.</p>

**Buttons**

**Add New Rule**

: click to add new rule.

**Apply**

: Click to apply changes

**Delete**

: Check to delete the entry.

### 4.8.8 PoE Alive Check Configuration

The IGS-6325 PoE Switch can be configured to monitor connected PD's status in real-time via ping action. Once the PD stops working and without response, IGS-6325 PoE Switch is going to restart PoE port power, and bring the PD back to work. It will greatly enhance the reliability and reduces administrator management burden.

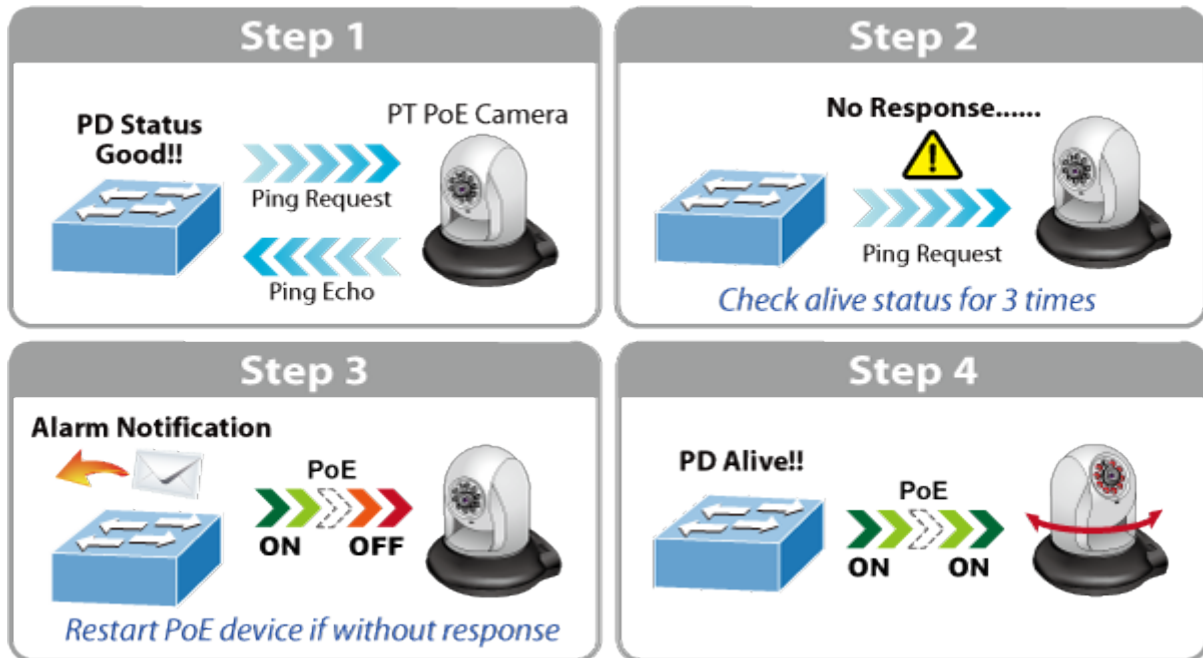

This page provides you how to configure PD Alive Check. The screen in Figure 4-8-1-7 appears.

PD Ping Alive Check									
Port	Mode	Ping PD IP Address	Interval Time(10~300s)	Retry Count(1~5)	Action	Reboot Time(30~180s)			
*	<All> ▼	0.0.0.0		30	2	<All> ▼			90
1	Disable ▼	0.0.0.0		30	2	None ▼			90
2	Disable ▼	0.0.0.0		30	2	None ▼			90

Figure 4-8-1-7: PD Alive Check Configuration Screenshot

The page includes the following fields:

Object	Description
• <b>Mode</b>	Allows user to enable or disable per port PD Alive Check function. As default value all ports are disabled.
• <b>Ping PD IP Address</b>	This column allows user to set PoE device IP address here for system making ping to the PoE device. Please be noticed that the PD's IP address must be set to the same network segment with IGS-6325 PoE Switch.

<ul style="list-style-type: none"> <li>• <b>Interval Time (10~300s)</b></li> </ul>	<p>This column allows user to set how long system should be issue a ping request to PD for detecting PD is alive or dead. Interval time range is from 10 seconds to 300 seconds.</p>
<ul style="list-style-type: none"> <li>• <b>Retry Count (1~5)</b></li> </ul>	<p>This column allows user to set how many times system rerry ping to PD. For example, if we set count 2, the meaning is that if system retry ping to the PD and the PD doesn't response continuously, the PoE port will be reset.</p>
<ul style="list-style-type: none"> <li>• <b>Action</b></li> </ul>	<p>Allows user to set which action will be apply if the PD witout any response. IGS-6325 PoE Switch offers 3 actions as following.</p> <ul style="list-style-type: none"> <li>➤ <b>PD Reboot:</b> It menas system will reset the PoE port that connected the PD.</li> <li>➤ <b>Reboot &amp; Alarm:</b> It means system will reset the PoE port and issue an alarm message via Syslog, SMTP.</li> <li>➤ <b>Alarm:</b> It means system will issue an alarm message via Syslog, SMTP.</li> </ul>
<ul style="list-style-type: none"> <li>• <b>PD Reboot Time (30~180s)</b></li> </ul>	<p>This column allows user to set the <b>PoE PD device rebooting time</b>, due to there are so many kind of PoE PD device on the market and theyhave different rebooting time. The PD Alive-check is not a defining standard, so the PoE PD device on the market doesn't report reboots done information to IGS-6325 PoE Switch, so user has to make sure <b>how long the PD will be finished to boot</b>, and then set the time value to this column.</p> <p>System is going to check the PD again according to the reboot time. If ou can not make sure precisely booting time, we suggest you to set it longer.</p>

**Buttons**

: Click it to save changes.

: Click it to reset configuration which doesn't to be saved yet.



### 4.8.9 LLDP PoE Neighbors

This page provides a status overview for all LLDP PoE neighbors. The displayed table contains a row for each port on which an LLDP PoE neighbor is detected. The columns hold the following information: The screen in Figure 4-8-1-8 appears.

LLDP Neighbor Power Over Ethernet Information				
Local Interface	Power Type	Power Source	Power Priority	Maximum Power
GigabitEthernet 1/2	PD Device	PSE	Unknown	25.5 [W]

Auto-refresh  Refresh

Figure 4-8-1-8: LLDP PoE Neighbor Screenshot

Please note that administrator has to enable LLDP port from **LLDP configuration**, please refer to the following example (The screen in Figure 4-8-1-9 appears.) To enable LLDP function from port1 to port3, administrator has to plug a PD that supports PoE LLDP function, and then administrator is going to see the PoE information of the PD from LLDP.

LLDP Configuration							
LLDP Parameters							
Tx Interval	30	seconds					
Tx Hold	4	times					
Tx Delay	2	seconds					
Tx Reinit	2	seconds					
LLDP Port Configuration							
Port	Mode	CDP Aware	Port Description	System Name	System Description	System Capabilities	Management Address
*	<All>	<input type="checkbox"/>	<input type="checkbox"/>	<input type="checkbox"/>	<input type="checkbox"/>	<input type="checkbox"/>	<input type="checkbox"/>
1	Enabled	<input type="checkbox"/>	<input checked="" type="checkbox"/>	<input checked="" type="checkbox"/>	<input checked="" type="checkbox"/>	<input checked="" type="checkbox"/>	<input checked="" type="checkbox"/>
2	Enabled	<input type="checkbox"/>	<input checked="" type="checkbox"/>	<input checked="" type="checkbox"/>	<input checked="" type="checkbox"/>	<input checked="" type="checkbox"/>	<input checked="" type="checkbox"/>
3	Enabled	<input type="checkbox"/>	<input checked="" type="checkbox"/>	<input checked="" type="checkbox"/>	<input checked="" type="checkbox"/>	<input checked="" type="checkbox"/>	<input checked="" type="checkbox"/>
4	Disabled	<input type="checkbox"/>	<input checked="" type="checkbox"/>	<input checked="" type="checkbox"/>	<input checked="" type="checkbox"/>	<input checked="" type="checkbox"/>	<input checked="" type="checkbox"/>
5	Disabled	<input type="checkbox"/>	<input checked="" type="checkbox"/>	<input checked="" type="checkbox"/>	<input checked="" type="checkbox"/>	<input checked="" type="checkbox"/>	<input checked="" type="checkbox"/>
38	Disabled	<input type="checkbox"/>	<input checked="" type="checkbox"/>	<input checked="" type="checkbox"/>	<input checked="" type="checkbox"/>	<input checked="" type="checkbox"/>	<input checked="" type="checkbox"/>

Figure 4-8-1-9: LLDP Configuration Screenshot

## 4.9 ONVIF

### 4.9.1 ONVIF Switch Introduction

ONVIF (Open Network Video Interface Forum) is a global and open industry forum with the goal of facilitating the development and use of a global open standard for the interface of physical IP-based security products – or, in other words, to create a standard for how IP products within video surveillance and other physical security areas can communicate with each other. The ONVIF specification aims to achieve interoperability between network video products regardless of manufacturer.



### 4.9.2 ONVIF Device Search

Entries in the ONVIF Devices Table are shown on this page. The ONVIF Devices Table can be sorted first by VLAN ID, model, MAC Address and then by IP Address. The ONVIF Devices Table screen in [Figure 4-9-2-1](#) appears.

### ONVIF Device Search

Query by:

<input type="checkbox"/> VLAN	<input type="text"/>
<input type="checkbox"/> Model	<input type="text"/>
<input type="checkbox"/> MAC Address	<input type="text"/>
<input type="checkbox"/> IP Address	<input type="text"/>

Please click "Search" to query or update the current list

Port	Device Type	Device Name	Manufacturer	Model	IP address	MAC address	VLAN	Select Device
2	IP camera	PLANET	PLANET	ICA-3250	192.168.0.204	00-30-4F-00-06-04	1	<input type="checkbox"/>

Auto Search

Please Select an ONVIF Device and click "Apply" for adding to the "ONVIF Device List"

Figure 4-9-2-1: ONVIF Devices Table Status Page Screenshot

#### Navigating the ONVIF Devices Table

The "Start from MAC address" and "VLAN", "Model", "MAC Address" and "IP Address" input fields allow the user to select the starting point in the ONVIF Devices Table. Clicking the "Refresh" button will update the displayed table which matches the ONVIF Devices Table.

The page includes the following fields:

Object	Description
• Port	This is the logical port number for this row.
• Device Type	Entry of the ONVIF Device's Type
• Device Name	Entry of the ONVIF Device's Name
• Manufacturer	Entry of the ONVIF Device's Manufacturer
• Model	Entry of the ONVIF Device's Model Name
• IP Address	Entry of the ONVIF Device's IP Address
• MAC Address	Entry of the ONVIF Device's MAC address
• VLAN	Entry of the ONVIF Device's VLAN ID
• Select Device	Select by ticking the ONVIF Devices to be added to the ONVIF Table List

## Buttons

: Click to search the connecting ONVIF devices.

: Click to apply changes

: Click to undo any changes made locally and revert to previously saved values.

Auto-search : Automatic search occurs every 60 seconds.

### 4.9.3 ONVIF Device List

This page provides an overview of ONVIF Device entries. Each page shows up to 10 entries from the ONVIF Device table list, default being 10, selected through the "entries per page" input field. When first visited, the web page will show the first 10 entries at the beginning of the ONVIF Device table list as the screen in [Figure 4-9-3-1](#) appears.

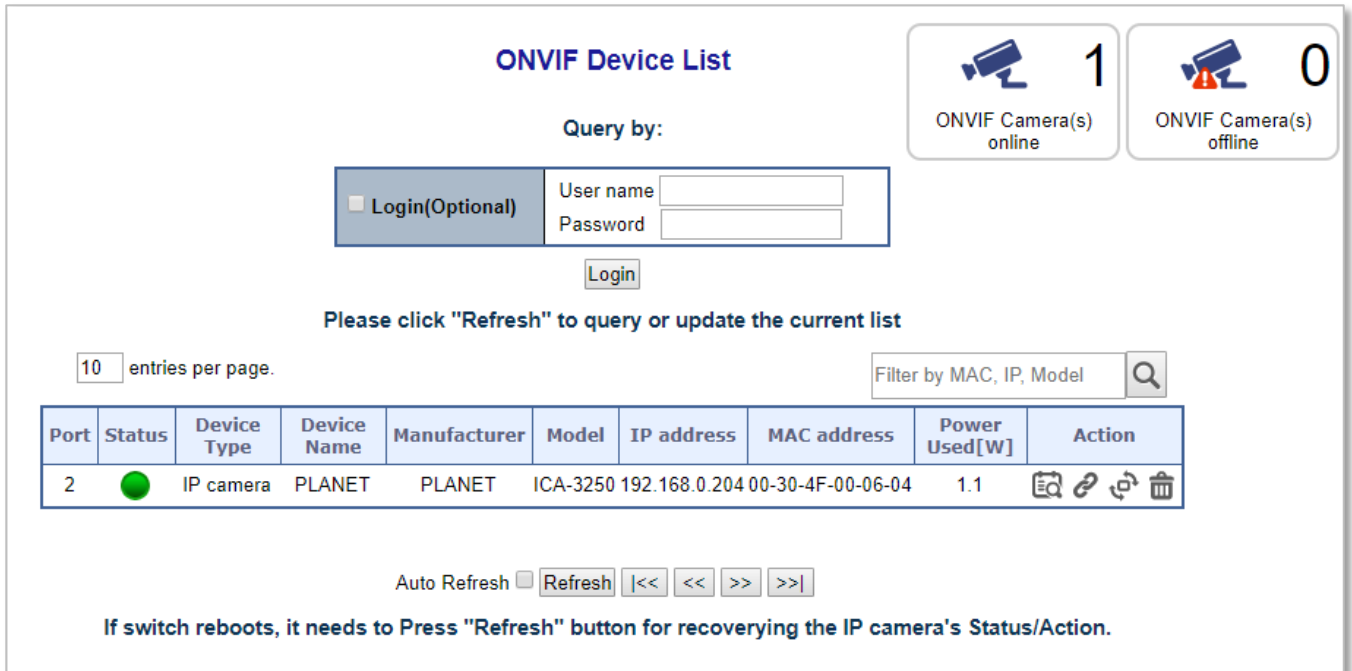

Figure 4-9-3-1: ONVIF Device List Page Screenshot

The page includes the following fields:

Object	Description
• <b>Login(Optional)</b>	Allows for filling in one set of User name and Password.
• <b>Port</b>	This is the logical port number for this row.
• <b>Status</b>	<b>Red:</b> The ONVIF device is not active. <b>Green:</b> The ONVIF device is active.Entry of the ONVIF Device's Type
• <b>Device Type</b>	Entry of the ONVIF Device's Type
• <b>Device Name</b>	Entry of the ONVIF Device's Name
• <b>Manufacturer</b>	Entry of the ONVIF Device's Manufacturer
• <b>Model</b>	Entry of the ONVIF Device's Model Name
• <b>IP Address</b>	Entry of the ONVIF Device's IP Address
• <b>MAC Address</b>	Entry of the ONVIF Device's MAC address
• <b>Power Used [W]</b>	The <b>Power Used</b> shows how much power the ONVIF device currently is using.
• <b>Action</b>	There are three actions:

---

---

	<p><b>Access:</b> Clicks for accessing the ONVIF device's Web UI.</p> <p><b>Reboot:</b> Clicks for rebooting the ONVIF device.</p> <p><b>Delete:</b> Clicks for deleting the ONVIF device from ONVIF Device List.</p>
--	---

---

---

**Buttons**

: Click to refresh the page immediately.

Auto-refresh : Check this box to refresh the page automatically. Automatic refresh occurs every 30 seconds.

: To update the ONVIF device entries, press to go to the first page.

: To update the ONVIF device entries, press to go to the front page.

: To update the ONVIF device entries, press to go to the next page.

: To update the ONVIF device entries, press to go to the final page.

### 4.9.4 Map Upload / Edit

This page allows the clients for uploading e-Map; the file size cannot be over 151k; the screen in [Figure 4-9-4-1](#) appears.

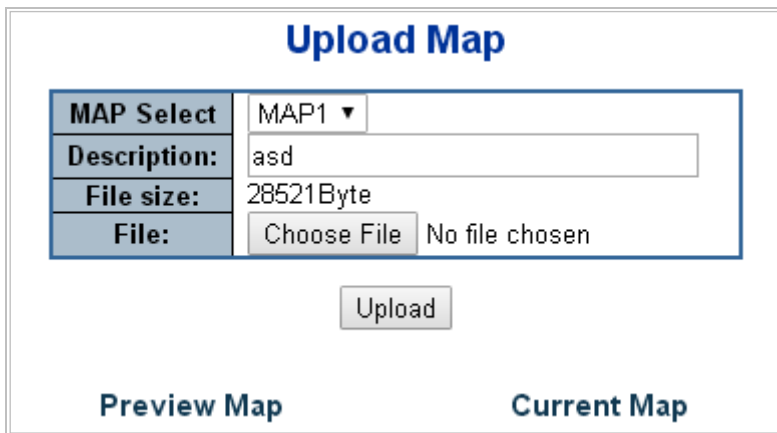

**Figure 4-9-4-1:** Map Upload / Edit Page Screenshot

The page includes the following fields:

Object	Description
• <b>MAP Select</b>	Allows to select Map1/2/3 for uploading Map.
• <b>Description</b>	Indicates the map's description.
• <b>File size</b>	Shows Map's size.
• <b>File</b>	Allows to choose and browse specific map file from laptop device.
• <b>Preview Map</b>	The Preview use of Map.
• <b>Current Map</b>	The Current use of Map.

#### Buttons

**Choose File**: Click to choose the file.

**Upload**: Click to upload the file.

### 4.9.5 Floor Map

This page allows the clients for planning the ONVIF devices with the uploaded e-Map. It can select the ONVIF devices from Device List and it also can modify the e-Map's Zoom and Scale as the screen in [Figure 4-9-5-1](#) appears.

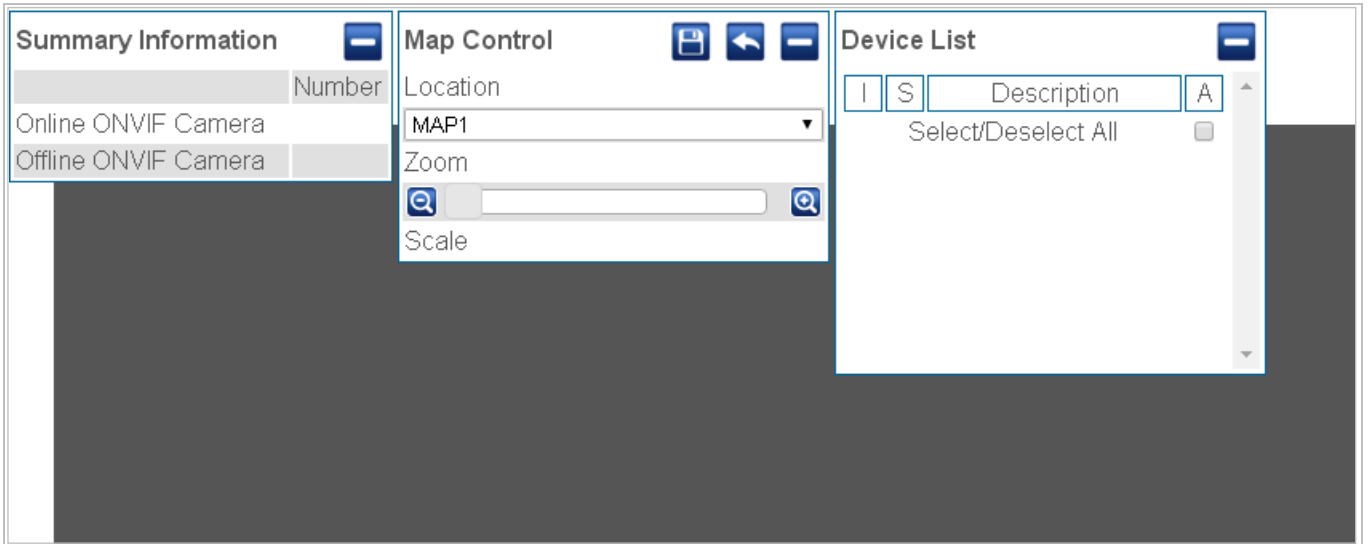

Figure 4-9-5-1: Floor Map Page Screenshot

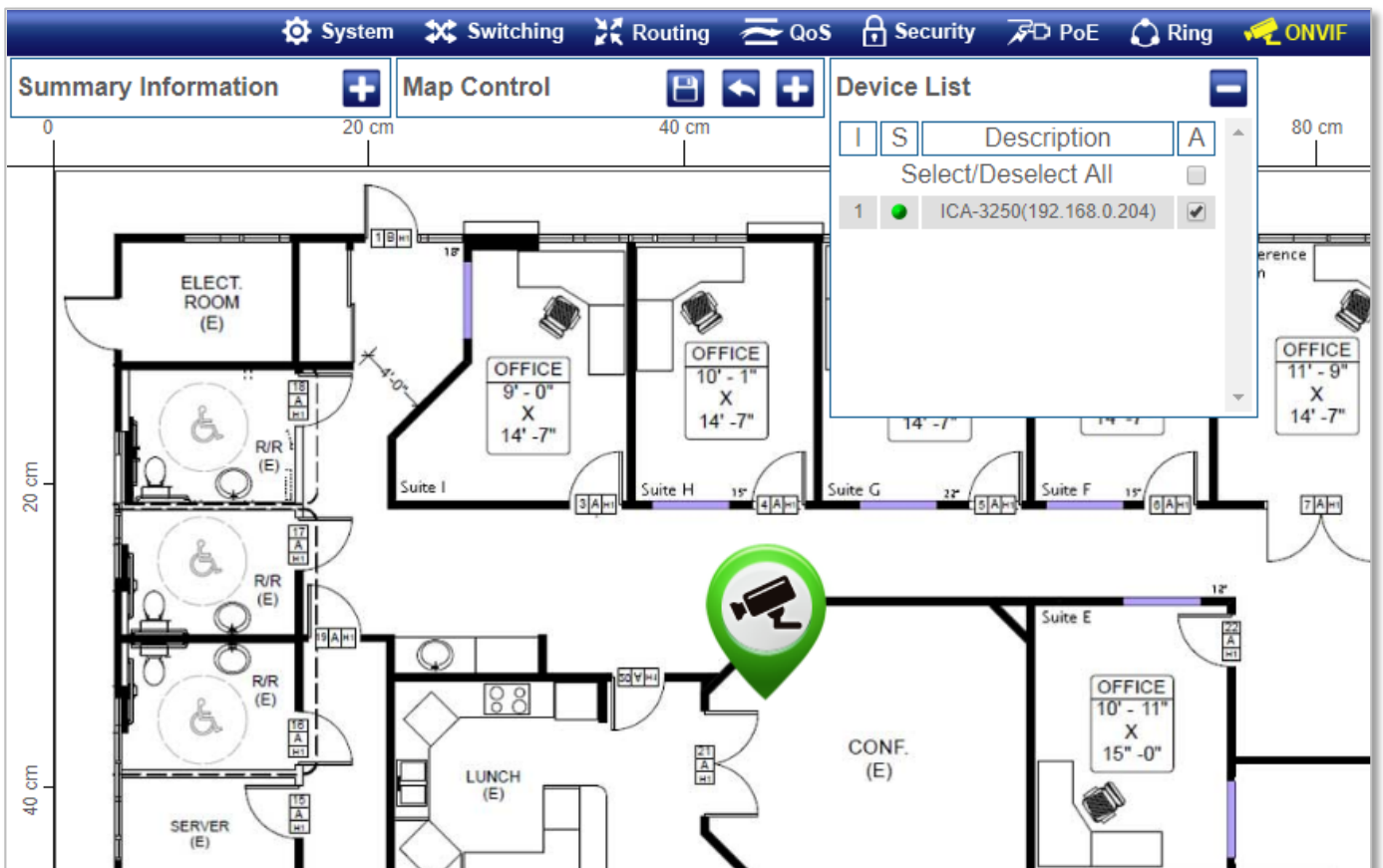

Figure 4-9-5-2: Floor Map Page Screenshot – add ONVIF IP camera from Device List





Figure 4-9-5-3: Floor Map Page Screenshot – Display device information of selected ONVIF IP camera

The page includes the following fields:

Object	Description
<ul style="list-style-type: none"> <li>• <b>Summary Information</b></li> </ul>	Shows the number of Online and Offline ONVIF cameras.
<ul style="list-style-type: none"> <li>• <b>Map Control</b></li> </ul>	Allows to choose Location of Map1/2/3 and zoom in/out of Map.
<ul style="list-style-type: none"> <li>• <b>Device List</b></li> </ul>	Allows to select ONVIF devices.

## 4.10 Routing

### 4.10.1 IP Configuration

The IP Configuration includes the IP Configuration, IP Interface and IP Routes. The configured column is used to view or change the IP configuration. The maximum number of interfaces supported is 128 and the maximum number of routes is 128. The screen in [Figure 4-10-1](#) appears.

**IP Configuration**

Domain Name	No Domain Name
Mode	Host
DNS Server	No DNS server
DNS Proxy	<input type="checkbox"/>

**IP Interfaces**

Delete	VLAN	DHCPv4			IPv4		DHCPv6			IPv6	
		Enable	Fallback	Current Lease	Address	Mask Length	Enable	Rapid Commit	Current Lease	Address	Mask Length
<input type="checkbox"/>	1	<input type="checkbox"/>	0		192.168.0.100	24	<input type="checkbox"/>	<input type="checkbox"/>			

**IP Routes**

Delete	Network	Mask Length	Gateway	Next Hop VLAN
<input type="button" value="Add Route"/>				

Figure 4-2-1: IP Configuration Page Screenshot

The current column is used to show the active IP configuration.

Object	Description	
• IP Configurations	<b>Domain Name</b>	Configure the Switch Domain Name
	<b>Mode</b>	Configure whether the IP stack should act as a Host or a Router. In Host mode, IP traffic between interfaces will not be routed. In Router mode traffic is routed between all interfaces.
	<b>DNS Server</b>	<p>This setting controls the DNS name resolution done by the switch. The following modes are supported:</p> <ul style="list-style-type: none"> <li>■ <b>No DNS server</b> No DNS server will be used..</li> <li>■ <b>Configure IPv4 or IPv6</b> Explicitly specify the name of local domain. Make sure the configured domain name meets your organization's given domain.</li> <li>■ <b>From any DHCPv6 interfaces</b> The first domain name offered from a DHCPv6 lease to a DHCPv6-enabled interface will be used.</li> <li>■ <b>From this DHCPv6 interface</b></li> </ul>

		Specify from which DHCPv6-enabled interface a provided domain name should be preferred.	
	<b>DNS Proxy</b>	When DNS proxy is enabled, system will relay DNS requests to the currently configured DNS server, and reply as a DNS resolver to the client devices on the network.	
• <b>IP Interface</b>	<b>Delete</b>	Select this option to delete an existing IP interface.	
	<b>VLAN</b>	The VLAN associated with the IP interface. Only ports in this VLAN will be able to access the IP interface. This field is only available for input when creating a new interface.	
	<b>IPv4 DHCP</b>	<b>Enabled</b>	Enable the DHCP client by checking this box.
		<b>Fallback</b>	The number of seconds for trying to obtain a DHCP lease.
		<b>Current Lease</b>	For DHCP interfaces with an active lease, this column shows the current interface address, as provided by the DHCP server.
	<b>IPv4</b>	<b>Address</b>	Provide the IP address of this Managed Switch in dotted decimal notation.
		<b>Mask Length</b>	The IPv4 network mask, in number of bits ( <i>prefix length</i> ). Valid values are between 0 and 30 bits for an IPv4 address.
	<b>DHCPv6</b>	<b>Enable</b>	Enable the DHCPv6 client by checking this box. If this option is enabled, the system will configure the IPv6 address of the interface using the DHCPv6 protocol
		<b>Rapid Commit</b>	Enable the DHCPv6 Rapid-Commit option by checking this box. If this option is enabled, the DHCPv6 client terminates the waiting process as soon as a Reply message with a Rapid Commit option is received. This option is only manageable when DHCPv6 client is enabled.
		<b>Current Lease</b>	For DHCPv6 interface with an active lease, this column shows the interface address provided by the DHCPv6 server
	<b>IPv6</b>	<b>Address</b>	Provide the IP address of this Managed Switch. An IPv6 address is in 128-bit records represented as eight fields of up to four hexadecimal digits with a colon separating each field (:).
		<b>Mask Length</b>	The IPv6 network mask, in number of bits ( <i>prefix length</i> ). Valid values are between 1 and 128 bits for an IPv6 address.
• <b>IP Routes</b>	<b>Delete</b>	Select this option to delete an existing IP route.	
	<b>Network</b>	The destination IP network or host address of this route. Valid format is dotted decimal notation or a valid IPv6 notation. A default route can use the value 0.0.0.0 or IPv6 :: notation.	
	<b>Mask Length</b>	The destination IP network or host mask, in number of bits ( <i>prefix length</i> ).	
	<b>Gateway</b>	The IP address of the IP gateway. Valid format is dotted decimal notation or a valid IPv6 notation. Gateway and Network must be of the same type.	

---

	<b>Next Hop VLAN</b>	The VLAN ID (VID) of the specific IPv6 interface associated with the gateway.
--	----------------------	---

---

**Buttons**

: Click to add a new IP interface. A maximum of 128 interfaces are supported.

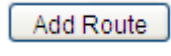
: Click to add a new IP route. A maximum of 32 routes are supported.

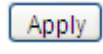
: Click to apply changes.

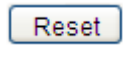
: Click to undo any changes made locally and revert to previously saved values.

### 4.10.2 IP Status

IP Status displays the status of the IP protocol layer. The status is defined by the IP interfaces, the IP routes and the neighbor cache (ARP cache) status. The screen in [Figure 4-10-2](#) appears.

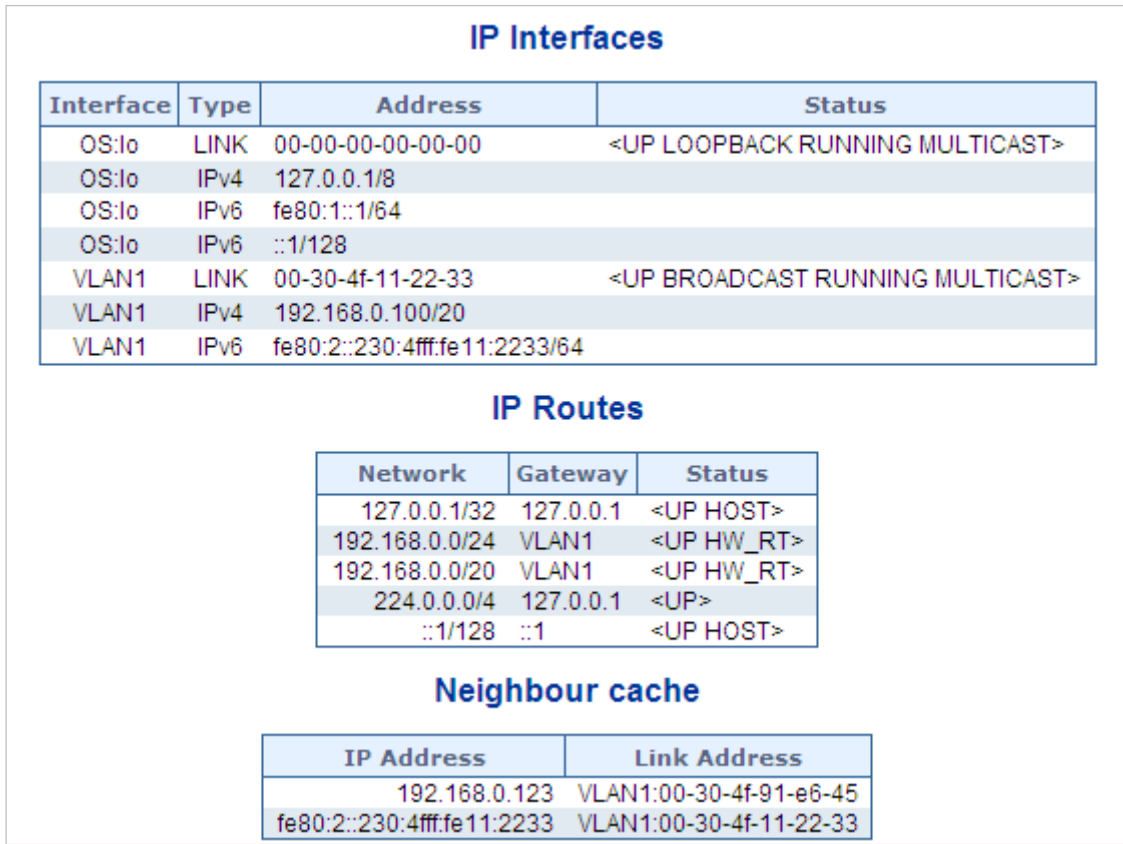

Figure 4-10-2: IP Status Page Screenshot

The page includes the following fields:

Object	Description	
• IP Interfaces	<b>Interface</b>	The name of the interface.
	<b>Type</b>	The address type of the entry. This may be <b>LINK</b> or <b>IPv4</b> .
	<b>Address</b>	The current address of the interface (of the given type).
	<b>Status</b>	The status flags of the interface (and/or address).
• IP Routes	<b>Network</b>	The destination IP network or host address of this route.
	<b>Gateway</b>	The gateway address of this route.
	<b>Status</b>	The status flags of the route.
• Neighbor Cache	<b>IP Address</b>	The IP address of the entry.
	<b>Link Address</b>	The Link (MAC) address for which a binding to the IP address given exists.

#### Buttons

Auto-refresh  : Check this box to refresh the page automatically. Automatic refresh occurs every 3 seconds.

: Click to refresh the page.

### 4.10.3 Routing Information Base

This is IPv4 route entry table. It is used to provide the route entries status information. The screen in Figure 4-10-3 appears.

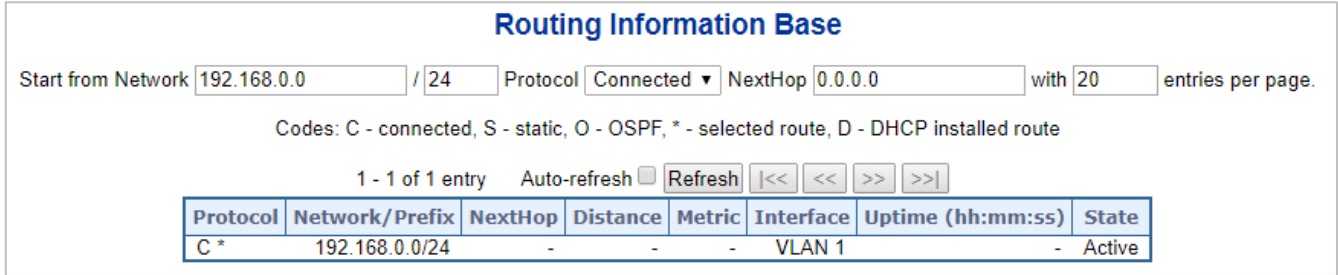

Figure 4-10-3: IP Status Page Screenshot

The page includes the following fields:

Object	Description
<b>Protocol</b>	The protocol of the route. <b>DHCP</b> : The route is created by DHCP. <b>Connected</b> : The destination network is connected directly. <b>Static</b> : The route is created by user. <b>OSPF</b> : The route is created by OSPF.
<b>Network/Prefix</b>	Network and prefix (example 10.0.0.0/16) of the given route entry.
<b>NextHop</b>	The IP address of nexthop. Value '0.0.0.0' indicates the link is directly connected.
<b>Distance</b>	The distance of the route.
<b>Metric</b>	The metric of the route.
<b>Interface</b>	The interface where the ip packet is outgoing.
<b>Uptime (hh:ss:mm)</b>	The time till the route is created. The unit is second.
<b>State</b>	Indicate if the destination network is reachable or not.

#### Buttons

: Click to refresh the page

Auto-refresh  : Check this box to refresh the page automatically. Automatic refresh occurs every 3 seconds.

: Updates the table entries, starting from the first available entry. If the first entry of the table is displayed, the button is disabled.

: Updates the table entries, ending at the entry prior to the first entry currently displayed. If the first entry of the table is displayed, the button is disabled.



Updates the table entries, starting from the entry next to the last entry currently displayed. If the last entry of the table is displayed, the button is disabled.



Updates the table entries, ending at the last available entry. If the last entry of the table is displayed, the button is disabled..

### 4.10.4 OSPF

**Open Shortest Path First (OSPF)** is a routing protocol for Internet Protocol (IP) networks. It uses a link state routing (LSR) algorithm and falls into the group of interior gateway protocols (IGPs), operating within a single autonomous system (AS).

To implement OSPF for a large network, you must first organize the network into logical areas to limit the number of OSPF routers that actively exchange **Link State Advertisements (LSAs)**. You can then define an OSPF interface by assigning an IP interface configured on this switch to one of these groups. This OSPF interface will send and receive OSPF traffic to neighboring OSPF routers. You can further optimize the exchange of OSPF traffic by specifying an area range that covers a large number of subnetwork addresses. This is an important technique for limiting the amount of traffic exchanged between **Area Border Routers (ABRs)**. And finally, you must specify a virtual link to any OSPF area that is not physically attached to the OSPF backbone. Virtual links can also be used to provide a redundant link between contiguous areas to prevent areas from being partitioned, or to merge backbone areas.

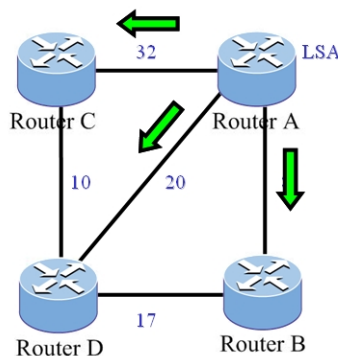
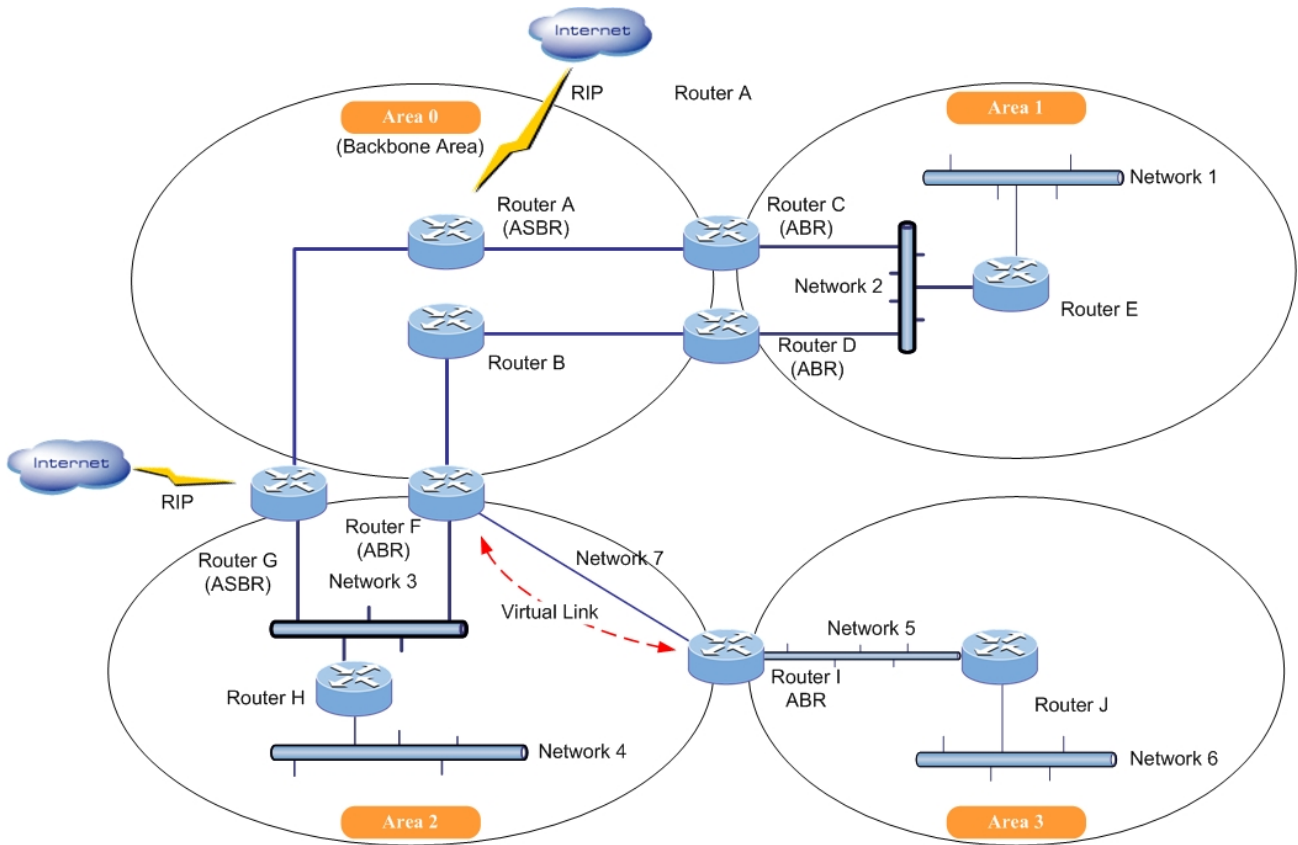

Neighbor	Metric
B	8
C	32
D	20

LSA of Router A



#### 4.10.4.1 Global Configuration

This is OSPF router configuration table. It is a general group to configure the OSPF common router parameters. The screen in Figure 4-10-4-1 appears.

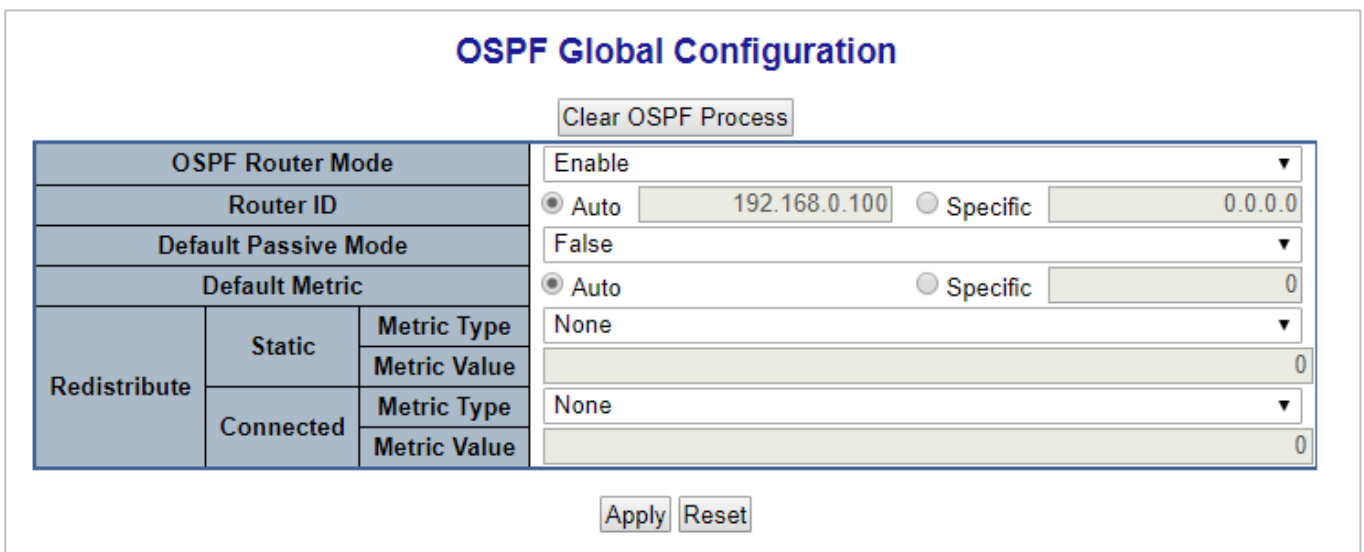
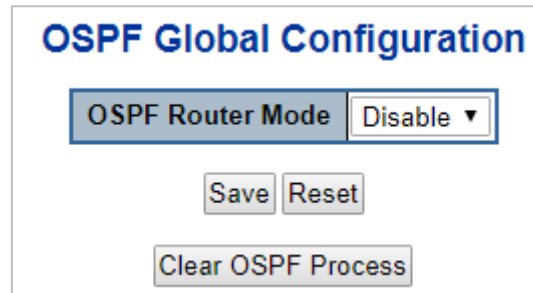

Figure 4-10-4-1: OSPF Global Configuration Page Screenshot

The page includes the following fields:

Object	Description
<b>OSPF Router Mode</b>	Enable/Disable the OSPF router mode.
<b>Router ID</b>	<p>The OSPF Router ID in IPv4 address format(A.B.C.D).</p> <p>When the router's OSPF Router ID is changed, if there is one or more fully adjacent neighbors in current OSPF area, the new router ID will take effect after restart OSPF process. Notice that the router ID should be unique in the Autonomous System and value '0.0.0.0' is invalid since it is reserved for the default algorithm.</p> <ul style="list-style-type: none"> <li>■ <b>Auto</b>: The default algorithm will choose the largest IP address assigned to the router.</li> <li>■ <b>Specific</b>: User specified router ID.</li> </ul>
<b>Default Passive Mode</b>	Configure all interfaces as passive-interface by default. When an interface is configured as a passive-interface, the OSPF routing updates sending is suppressed, therefore the interface does not establish adjacencies (No OSPF Hellos). The subnet of all interfaces (both passive and active) is advertised by the OSPF router.

<b>Default Metric</b>	<p>User specified default metric value for the OSPF routing protocol. The field is significant only when the argument 'IsSpecificDefMetric' is TRUE</p> <ul style="list-style-type: none"> <li>■ <b>Auto</b>: The default metric is calculated automatically based on the routing protocols.</li> <li>■ <b>Specific</b>: User specified default metric.</li> </ul>
<b>Static Redistribute Metric Type</b>	<ul style="list-style-type: none"> <li>■ The OSPF redistributed metric type for the connected interfaces.</li> <li>■ <b>None</b>: The static routes are not redistributed.</li> <li>■ <b>Specified Metric Value</b>: User specified metric for the static routes.</li> <li>■ <b>External Type 1</b>: External Type 1 of the static routes.</li> <li>■ <b>External Type 2</b>: External Type 2 of the static routes.</li> </ul>
<b>Static Redistribute Metric Value</b>	<p>User specified metric value for the connected interfaces. The field is significant only when the argument 'ConnectedRedistMetricType' is configured as 'metricTypeSpecified'.</p> <p>The allowed range is 0 to 1677214.</p>
<b>Connected Redistribute Metric Type</b>	<p>The OSPF redistributed metric type for the static routes.</p> <ul style="list-style-type: none"> <li>■ <b>None</b>: The connected interfaces are not redistributed.</li> <li>■ <b>Specified Metric Value</b>: User specified metric for the connected interfaces routes.</li> <li>■ <b>External Type 1</b>: External Type 1 of the connected interfaces routes.</li> <li>■ <b>External Type 2</b>: External Type 2 of the connected interfaces routes.</li> </ul>
<b>Connected Redistribute Metric Value</b>	<p>User specified metric value for the static routes. The field is significant only when the argument 'StaticRedistMetricType' is configured as 'metricTypeSpecified'.</p> <p>The allowed range is 0 to 1677214.</p>

**Buttons**

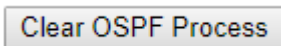
 : Click to reset the current OSPF process.

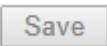
 : Click to save changes.

 : Click to undo any changes made locally and revert to previously saved values.

#### 4.10.4.2 Network Area

OSPF protocol broadcast messages (i.e., Link State Advertisements) are restricted by area to limit their impact on network performance. Before assigning an Area ID to a specific OSPF interface, you must first specify the Area ID in this table. Each entry in this table identifies a logical group of OSPF routers that actively exchange **Link State Advertisements (LSAs)** to ensure that they share an identical view of the network topology. You can configure the area as a normal one which can send and receive external **Link State Advertisements (LSAs)**, a stubby area that cannot send or receive external LSAs, or a **not-so-stubby area (NSSA)** that can import external route information into its area.

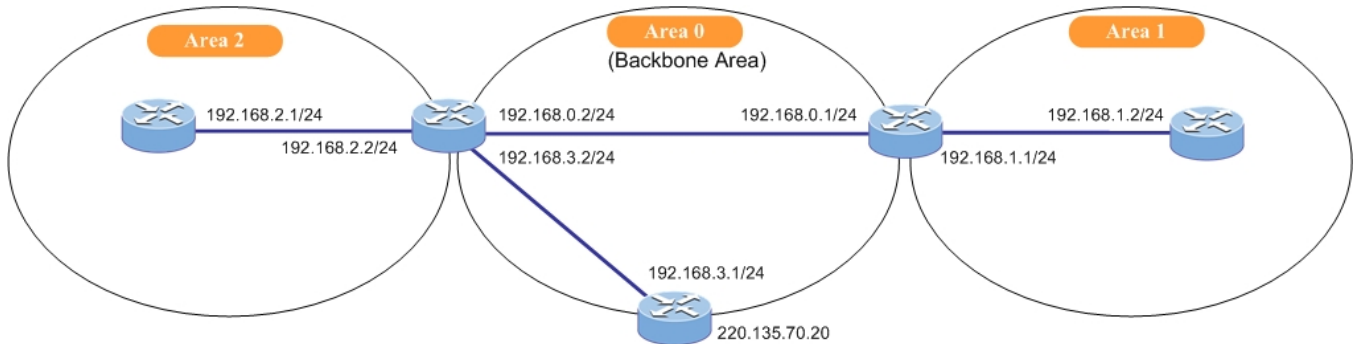

Following is OSPF area configuration table. It is used to specify the OSPF enabled interface(s). When OSPF is enabled on the specific interface(s), the router can provide the network information to the other OSPF routers via those interfaces. The screen in [Figure 4-10-4-2](#) appears.

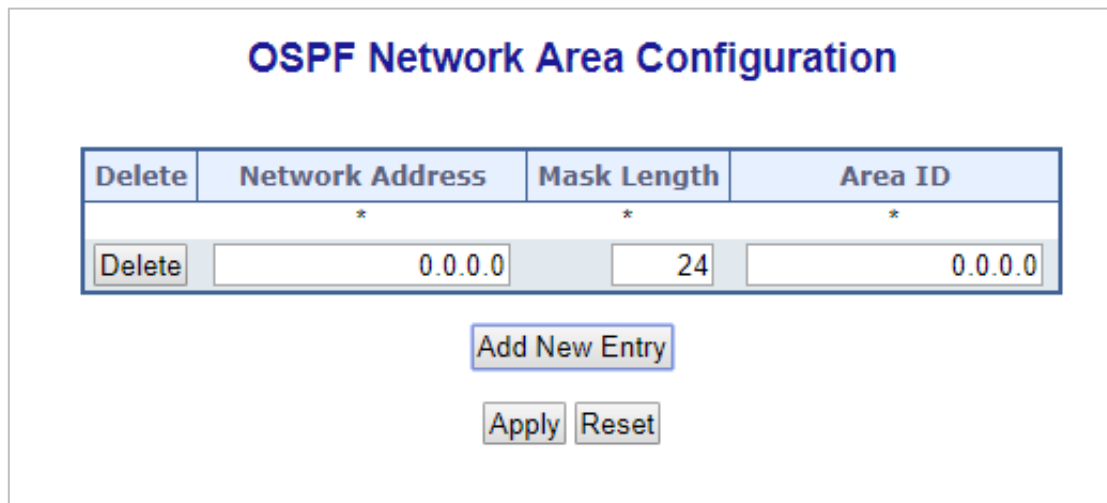

Figure 4-10-4-2: OSPF Network Area Page Screenshot

The page includes the following fields:

Object	Description
Network Address	IPv4 network address.
Mask Length	IPv4 network mask length.

<b>Area ID</b>	The OSPF area ID.
----------------	-------------------

**Buttons**

**Add New Entry** : Click to add new entry.

**Save** : Click to save changes.

**Reset** : Click to undo any changes made locally and revert to previously saved values.

**4.10.4.3 Passive Interface**

This is OSPF router interface configuration table. The screen in [Figure 4-10-4-3](#) appears.

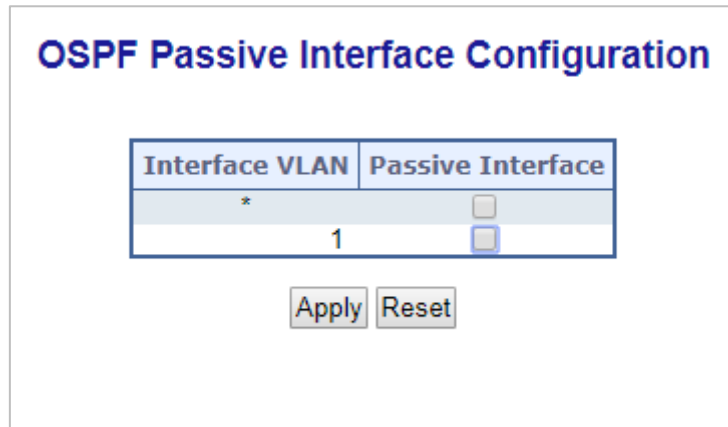

**Figure 4-10-4-3:** Passive Interface Page Screenshot

The page includes the following fields:

Object	Description
<b>Interface</b>	Interface identification.
<b>Passive Interface</b>	Enable the interface as OSPF passive-interface.

**Buttons**

**Save** : Click to save changes.

**Reset** : Click to undo any changes made locally and revert to previously saved values.

#### 4.10.4.4 Stub Area

This is OSPF stub area configuration table. The configuration is used to reduce the link-state database size and therefore the memory and CPU requirement by forbidding some LSAs. The screen in [Figure 4-10-4-10](#) appears.

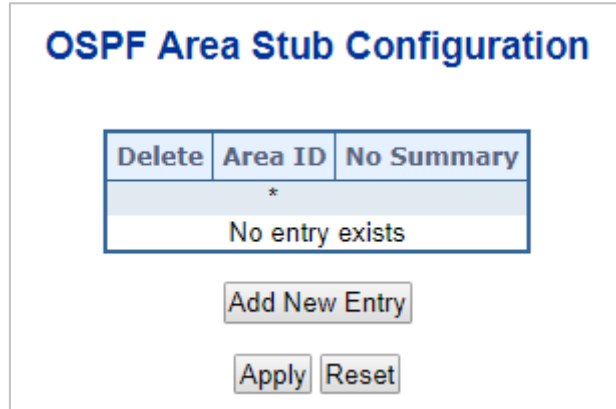

**Figure 4-10-4-10:** Stub Area Page Screenshot

The page includes the following fields:

Object	Description
<b>Area ID</b>	The OSPF area ID.
<b>No Summary</b>	<p>The value is true means the area is a totally stub area, which summary-LSAs(Type-3) except for the default route and AS-external-LSAs(Type-5) are blocked.</p> <p>The value is false means the area is a stub area, which summary-LSAs(Type-3) except for the default route are blocked.</p>

#### Buttons

**Add New Entry** : Click to add new entry.

**Save** : Click to save changes.

**Reset** : Click to undo any changes made locally and revert to previously saved values.

#### 4.10.4.5 Area Authentication

This is OSPF area authentication configuration table. It is used to applied the authentication to all the interfaces belong to the area. The screen in [Figure 4-10-4-5](#) appears.

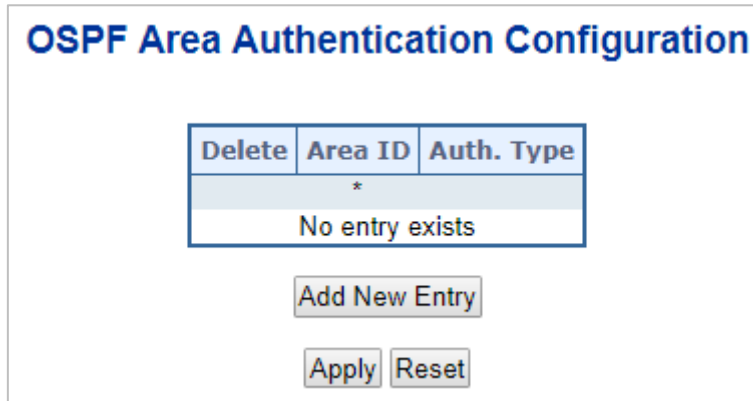

Figure 4-10-4-5: Area Authentication Page Screenshot

The page includes the following fields:

Object	Description
<b>Area ID</b>	The OSPF area ID.
<b>Auth. Type</b>	<p>The authentication type on an area is applied to all the interfaces belong to that area.</p> <p>The authentication type on an IP interface or a virtual link overrides the authentication type on an area and is useful if different interfaces in the same area use different authentication types.</p> <p>Specify the authenticaton type.</p> <p><b>Simple Password:</b> Simple password authentication.</p> <p><b>Message Digest:</b> MD5 digest authentication.</p>

#### Buttons

**Add New Entry** : Click to add new entry.

**Save** : Click to save changes.

**Reset** : Click to undo any changes made locally and revert to previously saved values.

#### 4.10.4.6 Area Range

This is OSPF area range configuration table. It is used to summarize the intra area paths from a specific address range in one summary-LSA(Type-3) and advertised to other areas or configure the address range status as 'DoNotAdvertise' which the summary-LSA(Type-3) is suppressed. The area range configuration is used for Area Border Routers (ABRs) and only router-LSAs(Type-1) and network-LSAs (Type-2) can be summarized. The AS-external-LSAs(Type-5) cannot be summarized because the scope is OSPF autonomous system (AS). The AS-external-LSAs(Type-7) cannot be summarized because the feature is not supported yet.. The screen in [Figure 4-10-4-6](#) appears.

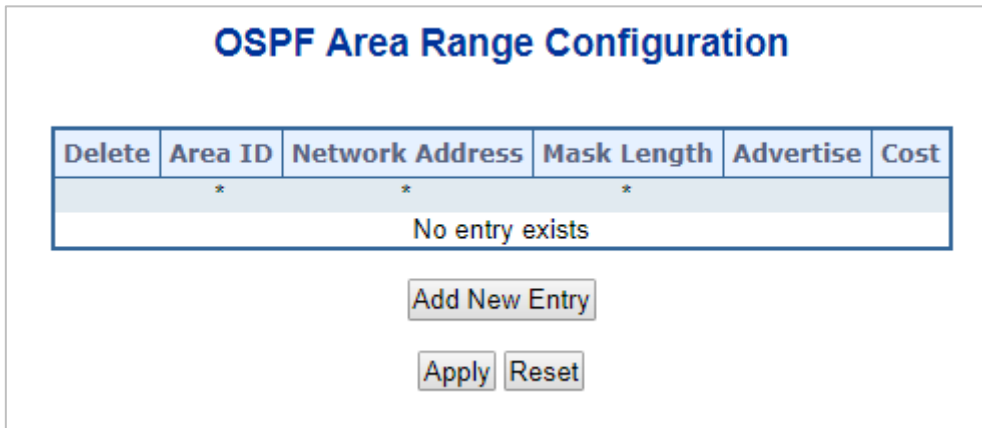

Figure 4-10-4-6: Area Range Page Screenshot

The page includes the following fields:

Object	Description
Area ID	The OSPF area ID.
Network Address	IPv4 network address.
Mask Length	IPv4 network mask length.
Advertised	When the value is true, it summarizes intra area paths from the address range in one summary-LSA(Type-3) and advertised to other areas. Otherwise, the intra area paths from the address range are not advertised to other areas.
Auto/Specific	When 'Auto' is selected, the cost value is set to 0 automatically and isn't allowed to be configured.
Cost	User specified cost (or metric) for this summary route. It is allowed to be configured only when 'Specific' is selected and the allowed range is 0 to 65535.. The allowed range is 1 to 16777215 and the default setting is 'auto cost' mode.

#### Buttons

**Add New Entry** : Click to add new entry.

**Save** : Click to save changes.

**Reset** : Click to undo any changes made locally and revert to previously saved values.

#### 4.10.4.7 Interface Configuration

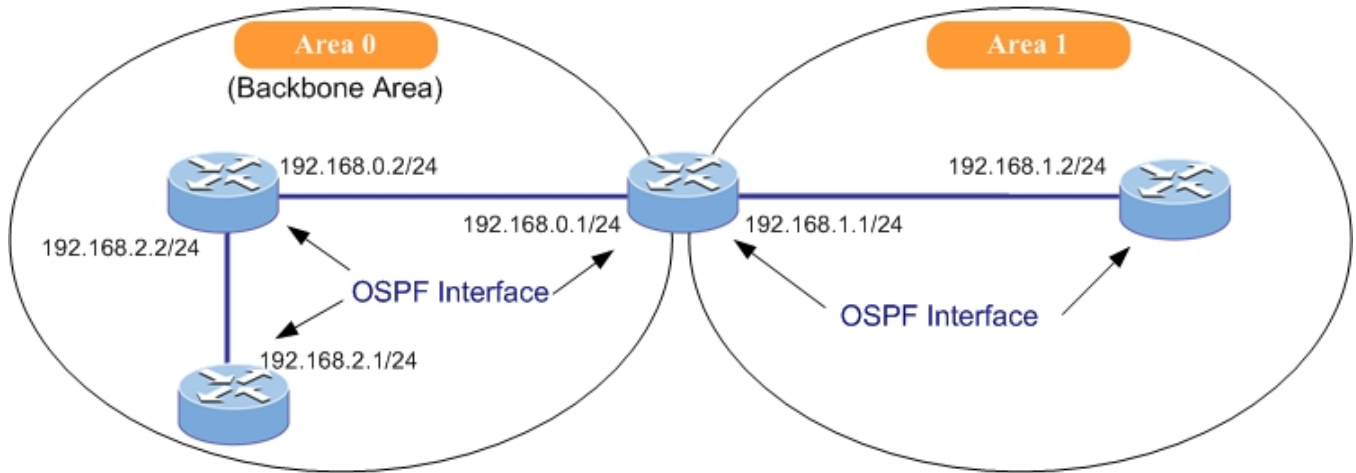

This is interface configuration parameter table. The screen in [Figure 4-10-4-7](#) appears.

Interface	Priority	Cost	FastHelloPackets	Interval			Auth. Type	Change Simple Password	MD Key		
				Hello	Dead	Retransmit					
*	1	<All>	0	<input type="checkbox"/>	2	10	40	5	<All>	*	*
VLAN 1	1	Auto	0	<input type="checkbox"/>	2	10	40	5	Area Configuration	<input type="checkbox"/>	

**Figure 4-10-4-7:** Interface Configuration Page Screenshot

The page includes the following fields:

Object	Description
<b>Interface</b>	Interface identification.
<b>Priority</b>	User specified router priority for the interface.  The allowed range is 0 to 255 and the default value is 1.
<b>Cost</b>	User specified cost for this interface. It's link state metric for the interface. The field is significant only when 'IsSpecificCost' is TRUE.  The allowed range is 1 to 65535 and the default setting is 'auto cost' mode.
<b>FastHelloPackets</b>	How many Hello packets will be sent per second.  The allowed range is 1 to 10 and the default setting is disabled.
<b>Hello Interval</b>	How many Hello packets will be sent per second.  The allowed range is 1 to 65535 and the default value is 10 (seconds).

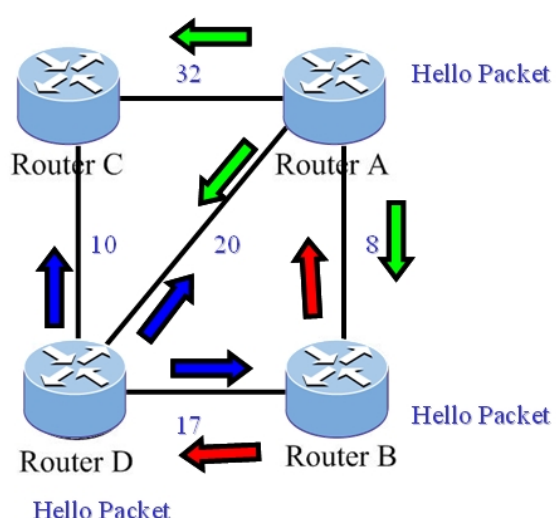

	
<p><b>Dead Interval</b></p>	<p>The time interval (in seconds) between hello packets.</p> <p>The allowed range is 1 to 65535 and the default value is 40 (seconds).</p>
<p><b>Retransmit Interval</b></p>	<p>The time interval (in seconds) between link-state advertisement(LSA) retransmissions for adjacencies.</p> <p>The allowed range is 1 to 65535 and the default value is 5 (seconds).</p>
<p><b>Auth. Type</b></p>	<p>The authentication type.</p> <ul style="list-style-type: none"> <li>■ <b>Simple Password:</b> It's using a plain text authentication. A password must be configured, but the password can be read by sniffer the packets.</li> <li>■ <b>Message Digest:</b> It's message-digest algorithm 5 (MD5) authentication. Keying material must also be configured. This is the most secure method.</li> <li>■ <b>Null Authentication:</b> No authentication.</li> <li>■ <b>Area Configuration:</b> Refer to Area authentication setting.</li> </ul>
<p><b>Change Simple Password</b></p>	<p>It is used to change the simple password (fill with plain text). The allowed input length is 1 to 8.</p>
<p><b>MD Key</b></p>	<p>Click the icon to edit the message digest key for the entry.</p>

**Buttons**

: Click to save changes.

: Click to undo any changes made locally and revert to previously saved values.

#### 4.10.4.8 Virtual Link

All OSPF areas must connect to the backbone. If an area does not have a direct physical connection to the backbone, you can configure a virtual link that provides a logical path to the backbone. To connect an isolated area to the backbone, the logical path can cross a single nonbackbone area to reach the backbone. To define the path, you must specify one endpoint on the ABR that connects the isolated area to the common nonbackbone area, and the other endpoint on the ABR that connects this common nonbackbone area and the backbone itself. (However, note that you cannot configure a virtual link that runs through a stub or NSSA area.)

Virtual links can also be used to create a redundant link between any area and the backbone to help prevent partitioning, or to connect two existing backbone areas into a common backbone.

To configure a virtual link, specify the transit area through which the endpoint routers connect, and the address of the router on this side of the link.

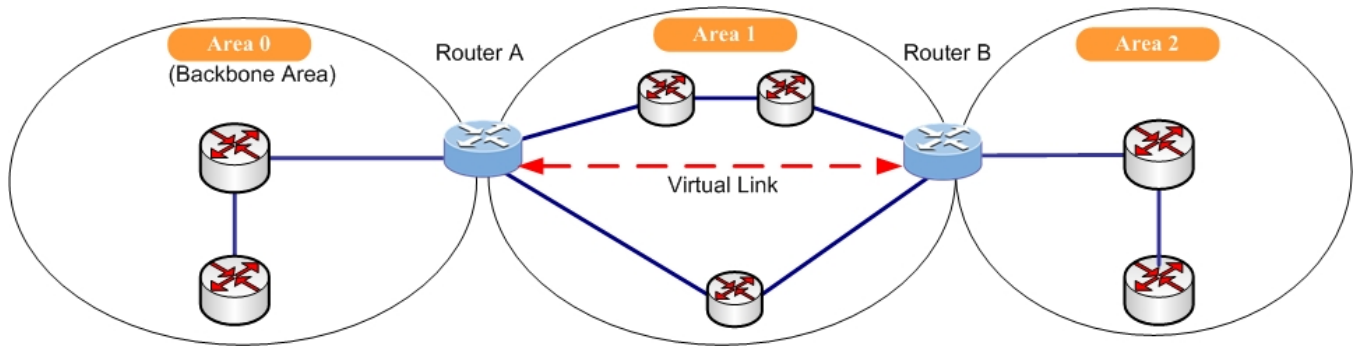

Following is OSPF virtual link configuration table. The virtual link is established between 2 ABRs to overcome that all the areas have to be connected directly to the backbone area. The screen in [Figure 4-10-4-8](#) appears.

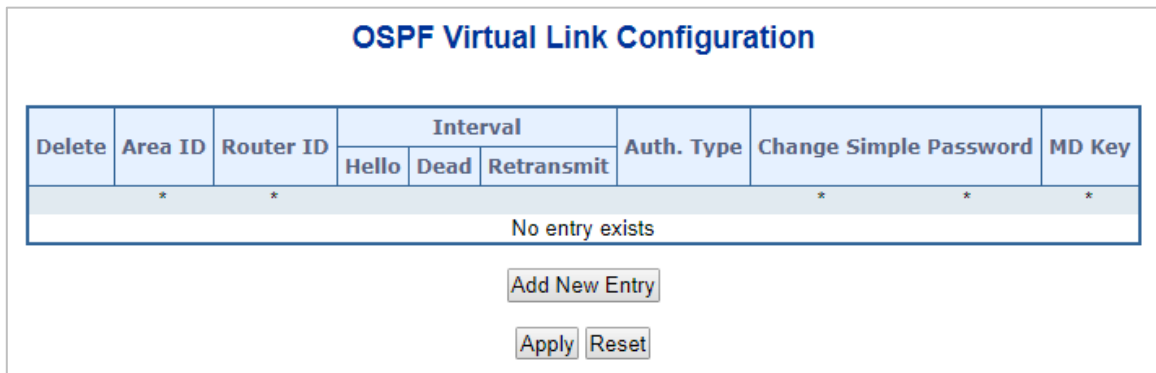

Figure 4-10-4-8: Virtual Link Page Screenshot

The page includes the following fields:

Object	Description
Area ID	OSPF Area ID.
Router ID	OSPF router ID.

<b>Hello Interval</b>	<p>The time interval (in seconds) between hello packets.</p> <p>The allowed range is 1 to 65535 and the default value is 10 (seconds).</p>
<b>Dead Interval</b>	<p>The number of seconds to wait until the neighbour is declared to be dead.</p> <p>The allowed range is 1 to 65535 and the default value is 40 (seconds).</p>
<b>Retransmit Interval</b>	<p>The time interval (in seconds) between link-state advertisement(LSA) retransmissions for adjacencies.</p> <p>The allowed range is 1 to 65535 and the default value is 5 (seconds).</p>
<b>Auth. Type</b>	<p>The authentication type on an area.</p> <ul style="list-style-type: none"> <li>■ <b>Simple Password:</b> It's using a plain text authentication. A password must be configured, but the password can be read by sniffer the packets.</li> <li>■ <b>Message Digest:</b> It's message-digest algorithm 5 (MD5) authentication. Keying material must also be configured. This is the most secure method.</li> <li>■ <b>Null Authentication:</b> No authentication.</li> <li>■ <b>Area Configuration:</b> Refer to Area authentication setting.</li> </ul>
<b>Change Simple Password</b>	<p>It is used to change the simple password (fill with plain text).</p> <p>The allowed input length is 1 to 8.</p>
<b>MD Key</b>	<p>Click the icon to edit the message digest key for the entry.</p>

**Buttons**

 : Click to add new entry.

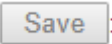
 : Click to save changes.

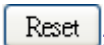
 : Click to undo any changes made locally and revert to previously saved values.

#### 4.10.4.9 Global Status

This is OSPF router status table. It is used to provide the OSPF router status information. The screen in [Figure 4-10-4-9](#) appears.

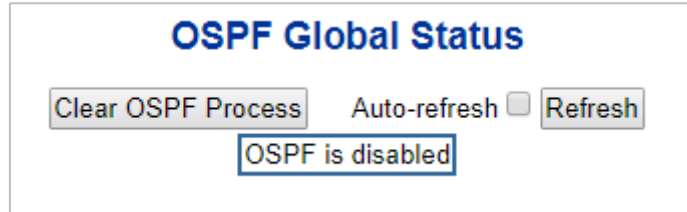

**Figure 4-10-4-9:** Virtual Link Page Screenshot

The page includes the following fields:

Object	Description
<b>Router ID</b>	OSPF router ID.
<b>SPF Delay</b>	Delay time (in seconds) of SPF calculations.
<b>SPF Hold Time</b>	Minimum hold time (in milliseconds) between consecutive SPF calculations.
<b>SPF Max. Wait Time</b>	Maximum wait time (in milliseconds) between consecutive SPF calculations.
<b>Last Executed SPF Time Stamp</b>	Time (in milliseconds) that has passed between the start of the SPF algorithm execution and the current time.
<b>Min. LSA Interval</b>	Minimum interval (in seconds) between link-state advertisements.
<b>Min. LSA Arrival</b>	Maximum arrival time (in milliseconds) of link-state advertisements.
<b>External LSA Count</b>	Number of external link-state advertisements.
<b>External LSA Checksum</b>	Number of external link-state checksum.
<b>Attached Area Count</b>	Number of areas attached for the router.

#### Buttons

**Clear OSPF Process** : Click to reset the current OSPF process.

**Auto-refresh**  Check this box to refresh the page automatically. Automatic refresh occurs every 3 seconds.

**Refresh** : Click to refresh the page immediately.

#### 4.10.4.10 Area Status

This is OSPF network area status table. It is used to provide the OSPF network area status information. The screen in [Figure 4-10-4-10](#) appears.

OSPF Area Status														
Auto-refresh <input type="checkbox"/> <input type="button" value="Refresh"/>														
Area ID	Backbone	Area Type	Active Interfaces	Auth. Type	SPF Executed Times	LSA Count	Router LSA		Network LSA		Summary LSA		ASBR Summary LSA	
							Count	Checksum	Count	Checksum	Count	Checksum	Count	Checksum
No entry exists														

Figure 4-10-4-10: Area Status Page Screenshot

The page includes the following fields:

Object	Description
Area ID	The Area ID.
Backbone	Indicate if it's backbone area or not.
Area Type	The area type.
Active Interfaces	Number of active interfaces attached in the area.
Auth. Type	The authentication type in the area.
SPF Executed Times	Number of times SPF algorithm has been executed for the particular area.
LSA Count	Number of the total LSAs for the particular area.
Router LSA Count	Number of the router-LSAs(Type-1) of a given type for the particular area.
Router LSA Checksum	The the router-LSAs(Type-1) checksum.
Network LSA Count	Number of the network-LSAs(Type-2) of a given type for the particular area.
Network LSA Checksum	The the network-LSAs(Type-2) checksum.
Summary LSA Count	Number of the summary-LSAs(Type-3) of a given type for the particular area.
Summary LSA Checksum	The the summary-LSAs(Type-3) checksum.
ASBR Summary LSA Count	Number of the ASBR-summary-LSAs(Type-4) of a given type for the particular area.
ASBR Summary LSA Checksum	The the ASBR-summary-LSAs(Type-4) checksum.

#### Buttons

**Auto-refresh**  Check this box to refresh the page automatically. Automatic refresh occurs every 3 seconds.

Click to refresh the page immediately.

#### 4.10.4.11 Neighbor Status

This is OSPF IPv4 neighbor status table. It is used to provide the OSPF neighbor status information. The screen in [Figure 4-10-4-11](#) appears.



Figure 4-10-4-11: Neighbor Status Page Screenshot

The page includes the following fields:

Object	Description
Neighbor ID	The Neighbor ID.
Priority	The priority of OSPF neighbor. It indicates the priority of the neighbor router. This item is used when selecting the DR for the network. The router with the highest priority becomes the DR.
State	The state of OSPF neighbor. It indicates the functional state of the neighbor router.
Dead Time	Dead timer. It indicates the amount of time remaining that the router waits to receive an OSPF hello packet from the neighbor before declaring the neighbor down.
Interface Address	The IP address.
Interface	The network interface.

#### Buttons

**Auto-refresh**  Check this box to refresh the page automatically. Automatic refresh occurs every 3 seconds.

**Refresh** : Click to refresh the page immediately.

#### 4.10.4.12 Interface Status

This is OSPF interface status table. It is used to provide the OSPF interface status information. The screen in [Figure 4-10-4-12](#) appears.

OSPF Interface Status																			
Auto-refresh <input type="checkbox"/> Refresh																			
Interface	Interface Address	Area ID	Router ID	State	DR		BDR		Pri	Cost	Interval Configuration(sec)				Hello Timer	Nbr Count	Adjacent Nbr Count	Passive	Transmit Delay
					ID	Address	ID	Address			Hello	Dead	Wait	Retransmit					
No entry exists																			

Figure 4-10-4-12: Interface Status Page Screenshot

The page includes the following fields:

Object	Description
<b>Interface</b>	Interface identification.
<b>Interface Address</b>	IPv4 network address.
<b>Area ID</b>	The OSPF area ID.
<b>Router ID</b>	The OSPF router ID.
<b>State</b>	The state of the link.
<b>DR ID</b>	The router ID of DR.
<b>DR Address</b>	The IP address of DR.
<b>BDR ID</b>	The router ID of BDR.
<b>BDR Address</b>	The IP address of BDR.
<b>Priority</b>	The OSPF priority. It helps determine the DR and BDR on the network to which this interface is connected.
<b>Cost</b>	The cost of the interface.
<b>Hello</b>	Hello timer. A time interval that a router sends an OSPF hello packet.
<b>Dead</b>	Dead timer. Dead timer is a time interval to wait before declaring a neighbor dead. The unit of time is the second.
<b>Wait</b>	This interval is used in Wait Timer. Wait timer is a single shot timer that causes the interface to exit waiting and select a DR on the network. Wait Time interval is the same as Dead time interval.
<b>Retransmit</b>	Retransmit timer. A time interval to wait before retransmitting a database description packet when it has not been acknowledged.
<b>Hello Timer</b>	Hello due timer. An OSPF hello packet will be sent on this interface after this due time.
<b>Nbr Count</b>	Neighbor count. This is the number of OSPF neighbors discovered on this interface.

<b>Adjacent Nbr Count</b>	Adjacent neighbor count. This is the number of routers running OSPF that are fully adjacent with this router.
<b>Passive</b>	Indicate if the interface is passive interface.
<b>Transmit Delay</b>	The estimated time to transmit a link-state update packet on the interface.

**Buttons**

**Auto-refresh**  Check this box to refresh the page automatically. Automatic refresh occurs every 3 seconds.

**Refresh** : Click to refresh the page immediately.



#### 4.10.4.13 Configuration Example of OSPFv4

This scenario takes an OSPF autonomous system consists of three switches for example.

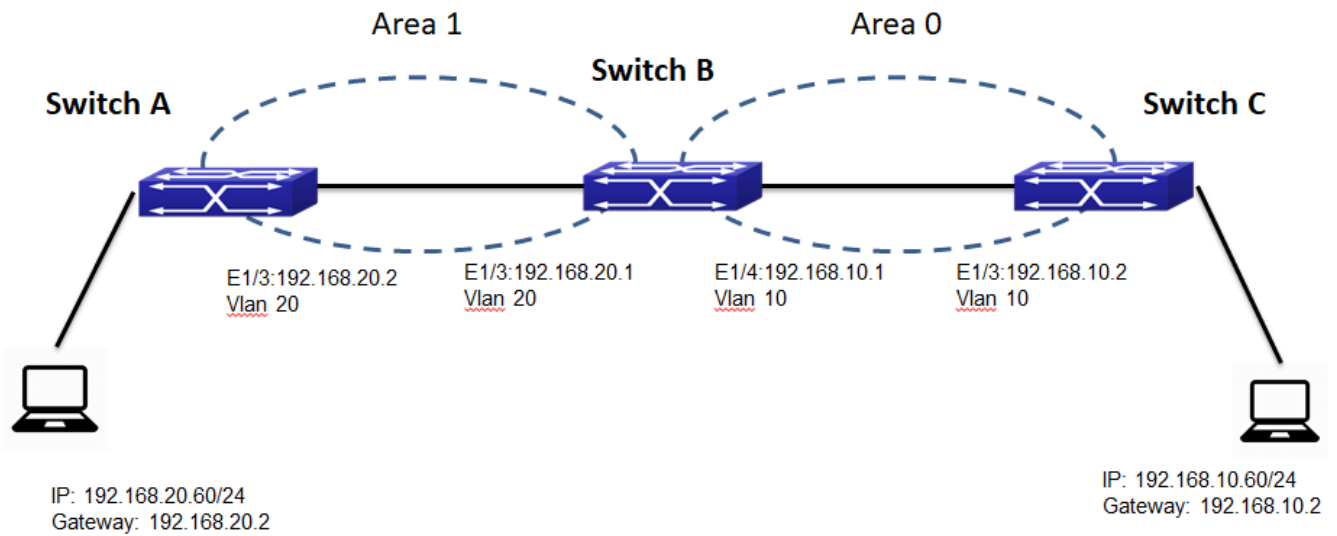

Figure 4-10-4-13 Network topology of OSPF autonomous system

The OSPF configuration is a two-step process:

- 1) Enable OSPF in the Global Mode;
- 2) Configure OSPF area for the interfaces.

The configuration step is as follows:

##### Enable OSPF protocol (required)

- (1) Enable/disable OSPF protocol (required)
- (2) Configure the ID number of the layer3 switch running OSPF (optional)
- (3) Configure the network scope for running OSPF (optional)
- (4) Configure the area for the interface (required)

The configuration for layer3 Switch A to Switch C is shown below:

##### Layer 3 Switch A

**Step 1.** Add port 3 as hybrid port allowed VLAN 1,10,20

Port	Mode	Port VLAN	Port Type	Ingress Filtering	Ingress Acceptance	Egress Tagging	Allowed VLANs	Forbidden VLANs
3	Hybrid	20	C-Port	<input type="checkbox"/>	Tagged and Untagged	Untag Port VLAN	1,10,20	

**Step 2.** Set router mode in IP configuration

##### IP Configuration

Domain Name	No Domain Name	<input type="text"/>
Mode	Router	<input type="text"/>
DNS Server	No DNS server	<input type="text"/>
DNS Proxy	<input type="checkbox"/>	

Step 3. Add interface VLAN10: 192.168.20.2/24

### IP Interfaces

Delete	VLAN	DHCPv4							IPv4		
		Enable	Client ID				Hostname	Fallback	Current Lease	Address	Mask Length
			Type	IfMac	ASCII	HEX					
<input type="checkbox"/>	20	<input type="checkbox"/>	Auto	Port 1					0	192.168.20.2	24

Step 4. Enable OSPF protocol

### OSPF Global Configuration

Clear OSPF Process

**OSPF Router Mode** Enable

Step 5. Configure area as 1

### OSPF Network Area Configuration

Delete	Network Address	Mask Length	Area ID
<input type="checkbox"/>	*	*	*
<input type="checkbox"/>	192.168.20.0	24	0.0.0.1

## Layer 3 Switch B

Step 1. Add port 3,4 as hybrid port allowed VLAN 1,10,20

Port	Mode	Port VLAN	Port Type	Ingress Filtering	Ingress Acceptance	Egress Tagging	Allowed VLANs	Forbidden VLANs
3	Hybrid	20	C-Port	<input type="checkbox"/>	Tagged and Untagged	Untag Port VLAN	1,10,20	
4	Hybrid	10	C-Port	<input type="checkbox"/>	Tagged and Untagged	Untag Port VLAN	1,10,20	

Step 2. Set router mode in IP configuration

### IP Configuration

<b>Domain Name</b>	No Domain Name	<input type="text"/>
<b>Mode</b>	Router	
<b>DNS Server</b>	No DNS server	<input type="text"/>
<b>DNS Proxy</b>	<input type="checkbox"/>	

Step 3. Add interface

VLAN10: 192.168.10.1/24

VLAN20: 192.168.20.1/24

### IP Interfaces

Delete	VLAN	DHCPv4							IPv4		
		Enable	Client ID				Hostname	Fallback	Current Lease	Address	Mask Length
			Type	IfMac	ASCII	HEX					
<input type="checkbox"/>	10	<input type="checkbox"/>	Auto	Port 1					0	192.168.10.1	24
<input type="checkbox"/>	20	<input type="checkbox"/>	Auto	Port 1					0	192.168.20.1	24

Step 4. Enable OSPF protocol

### OSPF Global Configuration

Clear OSPF Process

<b>OSPF Router Mode</b>	Enable
-------------------------	--------

Step 4. Configure 192.168.10.0 as area 0 and 192.168.20.0 as area 1

### OSPF Network Area Configuration

Delete	Network Address	Mask Length	Area ID
<input type="checkbox"/>	*	*	*
<input type="checkbox"/>	192.168.10.0	24	0.0.0.0
<input type="checkbox"/>	192.168.20.0	24	0.0.0.1

### Layer 3 Switch C

Step 1. Add port 3 as hybrid port allowed VLAN 1,10,20

Port	Mode	Port VLAN	Port Type	Ingress Filtering	Ingress Acceptance	Egress Tagging	Allowed VLANs	Forbidden VLANs
3	Hybrid	10	C-Port	<input type="checkbox"/>	Tagged and Untagged	Untag Port VLAN	1,10,20	

Step 2. Set router mode in IP configuration

### IP Configuration

<b>Domain Name</b>	No Domain Name	
<b>Mode</b>	Router	
<b>DNS Server</b>	No DNS server	
<b>DNS Proxy</b>	<input type="checkbox"/>	

Step 3. Add interface VLAN10: 192.168.10.2/24

### IP Interfaces

Delete	VLAN	Enable	DHCPv4					IPv4			
			Client ID				Hostname	Fallback	Current Lease	Address	Mask Length
			Type	IfMac	ASCII	HEX					
<input type="checkbox"/>	10	<input type="checkbox"/>	Auto	Port 1					0	192.168.10.2	24

Step 4. Enable OSPF protocol

### OSPF Global Configuration

Clear OSPF Process

<b>OSPF Router Mode</b>	Enable
-------------------------	--------

Step 5. Configure area as 0

## OSPF Network Area Configuration

Delete	Network Address	Mask Length	Area ID
<input type="checkbox"/>	*	*	*
<input type="checkbox"/>	192.168.10.0	24	0.0.0.0

Check the OSPF interface of Switch A to C

### Switch A

#### OSPF Interface Status

Auto-refresh  Refresh

Interface	Interface Address	Area ID	Router ID	State	DR		BDR		Pri	Cost	Interval Configuration(sec)				Hello Timer
					ID	Address	ID	Address			Hello	Dead	Wait	Retransmit	
VLAN 20	192.168.20.2/24	0.0.0.1	192.168.20.2	BDR	192.168.20.1	192.168.20.1	192.168.20.2	192.168.20.2	1	10	10	40	40	5	00:00:09

### Switch B

#### OSPF Interface Status

Auto-refresh  Refresh

Interface	Interface Address	Area ID	Router ID	State	DR		BDR		Pri	Cost	Interval Configuration(sec)				Hello Timer
					ID	Address	ID	Address			Hello	Dead	Wait	Retransmit	
VLAN 10	192.168.10.1/24	0.0.0.0	192.168.20.1	DR	192.168.20.1	192.168.10.1	192.168.10.2	192.168.10.2	1	10	10	40	40	5	00:00:04
VLAN 20	192.168.20.1/24	0.0.0.1	192.168.20.1	DR	192.168.20.1	192.168.20.1	192.168.20.2	192.168.20.2	1	10	10	40	40	5	00:00:04

### Switch C

#### OSPF Interface Status

Auto-refresh  Refresh

Interface	Interface Address	Area ID	Router ID	State	DR		BDR		Pri	Cost	Interval Configuration(sec)				Hello Timer
					ID	Address	ID	Address			Hello	Dead	Wait	Retransmit	
VLAN 10	192.168.10.2/24	0.0.0.0	192.168.10.2	BDR	192.168.20.1	192.168.10.1	192.168.10.2	192.168.10.2	1	10	10	40	40	5	00:00:09

Ping test from 192.168.10.60 to 192.168.20.60

```
Windows IP Configuration

Ethernet adapter GbE:

    Connection-specific DNS Suffix . . . : 
    IPv6 Address. . . . . : 2001:db8:0:1::198
    Link-local IPv6 Address . . . . . : fe80::a5d6:5d2e:18ab:9f40%7
    IPv4 Address. . . . . : 192.168.10.60
    Subnet Mask . . . . . : 255.255.255.0
    Default Gateway . . . . . : 192.168.10.2
```

```
Pinging 192.168.20.60 with 32 bytes of data:
Reply from 192.168.20.60: bytes=32 time<1ms TTL=126
Reply from 192.168.20.60: bytes=32 time<1ms TTL=126
Reply from 192.168.20.60: bytes=32 time=55ms TTL=126
Reply from 192.168.20.60: bytes=32 time=1ms TTL=126
Reply from 192.168.20.60: bytes=32 time=1ms TTL=126
Reply from 192.168.20.60: bytes=32 time=1ms TTL=126
Reply from 192.168.20.60: bytes=32 time=3ms TTL=126
Reply from 192.168.20.60: bytes=32 time=1ms TTL=126
```

## 5. SWITCH OPERATION

### 5.1 Address Table

The **Industrial Managed Switch** is implemented with an address table. This address table is composed of many entries. Each entry is used to store the address information of some nodes in the network, including MAC address, port no., etc. This information comes from the learning process of **Industrial Managed Switch**.

### 5.2 Learning

When one packet comes in from any port, the **Industrial Managed Switch** will record the source address, port no., and the other related information in address table. This information will be used to decide either forwarding or filtering for future packets.

### 5.3 Forwarding & Filtering

When one packet comes from some port of the **Industrial Managed Switch**, it will also check the destination address besides the source address learning. The **Industrial Managed Switch** will look up the address-table for the destination address. If not found, this packet will be forwarded to all the other ports except the port, which this packet comes in. And these ports will transmit this packet to the network it connected. If found, and the destination address is located at a different port from this packet comes in, the **Industrial Managed Switch** will forward this packet to the port where this destination address is located according to the information from address table. But, if the destination address is located at the same port with this packet comes in, then this packet will be filtered, thereby increasing the network throughput and availability.

### 5.4 Store-and-Forward

Store-and-Forward is one type of packet-forwarding techniques. A Store-and-Forward **Industrial Managed Switch** stores the incoming frame in an internal buffer and do the complete error checking before transmission. Therefore, no error packets occur; it is the best choice when a network needs efficiency and stability.

The **Industrial Managed Switch** scans the destination address from the packet-header, searches the routing table provided for the incoming port and forwards the packet, only if required. The fast forwarding makes the switch attractive for connecting servers directly to the network, thereby increasing throughput and availability. However, the switch is most commonly used to segment existence hubs, which nearly always improves the overall performance. An Ethernet switching can be easily configured in any Ethernet network environment to significantly boost bandwidth using the conventional cabling and adapters.

Due to the learning function of the **Industrial Managed Switch**, the source address and corresponding port number of each incoming and outgoing packet are stored in a routing table. This information is subsequently used to filter packets whose destination address is in the same segment as the source address. This confines network traffic to its respective domain and reduce the overall load on the network.

The **Industrial Managed Switch** performs "**Store and Fforward**"; therefore, no error packets occur. More reliably, it reduces the re-transmission rate. No packet loss will occur.

## 5.5 Auto-Negotiation

The STP ports on the Switch have built-in "**Auto-negotiation**". This technology automatically sets the best possible bandwidth when a connection is established with another network device (usually at Power On or Reset). This is done by detecting the modes and speeds both connected devices are capable of. Both 10BASE-T and 100BASE-TX devices can connect with the port in either half- or full-duplex mode. 1000BASE-T can be only connected in full-duplex mode.

## 6. TROUBLESHOOTING

This chapter contains information to help you solve issues. If the **Industrial Managed Switch** is not functioning properly, make sure the **Industrial Managed Switch** was set up according to instructions in this manual.

### ■ The Link LED is not lit.

**Solution:** Check the cable connection and remove duplex mode of the **Industrial Managed Switch**.

### ■ Some stations cannot talk to other stations located on the other port.

**Solution:** Please check the VLAN settings, trunk settings, or port enabled/disabled status.

### ■ Performance is bad.

**Solution:** Check the full duplex status of the **Industrial Managed Switch**. If the **Industrial Managed Switch** is set to full duplex and the partner is set to half duplex, then the performance will be poor. Please also check the in/out rate of the port.

### ■ Why the Switch doesn't connect to the network.

**Solution:**

1. Check the LNK/ACT LED on the switch.
2. Try another port on the Switch.
3. Make sure the cable is installed properly.
4. Make sure the cable is the right type.
5. Turn off the power. After a while, turn on power again.

### ■ 1000BASE-T port link LED is lit, but the traffic is irregular.

**Solution:** Check that the attached device is not set to dedicate full duplex. Some devices use a physical or software switch to change duplex modes. Auto-negotiation may not recognize this type of full-duplex setting.

### ■ Switch does not power up.

**Solution:**

1. DC wire or AC power cord is not inserted or faulty.
2. Check that the DC wire/AC power cord is inserted correctly.
3. Replace the DC wire/AC power cord if the cord is inserted correctly; check that the DC/AC power source is working

by connecting a different device in place of the switch.

4. If that device works, refer to the next step.
5. If that device does not work, check the DC/AC power.



## APPENDIX A: Networking Connection

### A.1 Switch's Data RJ45 Pin Assignments - 1000Mbps, 1000BASE-T

PIN NO	MDI	MDI-X
1	BI_DA+	BI_DB+
2	BI_DA-	BI_DB-
3	BI_DB+	BI_DA+
4	BI_DC+	BI_DD+
5	BI_DC-	BI_DD-
6	BI_DB-	BI_DA-
7	BI_DD+	BI_DC+
8	BI_DD-	BI_DC-

Implicit implementation of the crossover function within a twisted-pair cable, or at a wiring panel, while not expressly forbidden, is beyond the scope of this standard.

### A.2 10/100Mbps, 10/100BASE-TX

When connecting your Switch to another Fast Ethernet switch, a bridge or a hub, a straight or crossover cable is necessary. Each port of the Switch supports auto-MDI/MDI-X detection. That means you can directly connect the Switch to any Ethernet devices without making a crossover cable. The following table and diagram show the standard RJ45 receptacle/ connector and their pin assignments:

RJ45 Connector pin assignment		
PIN NO	MDI Media Dependent Interface	MDI-X Media Dependent Interface-Cross
1	Tx + (transmit)	Rx + (receive)
2	Tx - (transmit)	Rx - (receive)
3	Rx + (receive)	Tx + (transmit)
4, 5	Not used	
6	Rx - (receive)	Tx - (transmit)
7, 8	Not used	

The standard cable, RJ45 pin assignment

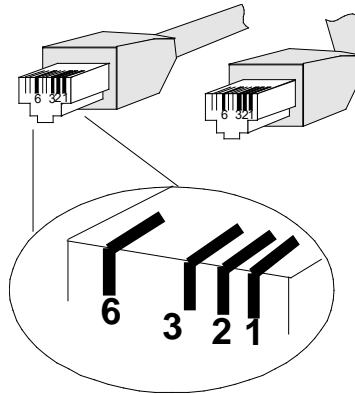

The standard RJ45 receptacle/connector

There are 8 wires on a standard UTP/STP cable and each wire is color-coded. The following shows the pin allocation and color of straight-through cable and crossover cable connection:

Straight Cable		SIDE 1	SIDE 2
	<p>SIDE 1</p> <p>SIDE 2</p>	<p>1 = White / Orange</p> <p>2 = Orange</p> <p>3 = White / Green</p> <p>4 = Blue</p> <p>5 = White / Blue</p> <p>6 = Green</p> <p>7 = White / Brown</p> <p>8 = Brown</p>	<p>1 = White / Orange</p> <p>2 = Orange</p> <p>3 = White / Green</p> <p>4 = Blue</p> <p>5 = White / Blue</p> <p>6 = Green</p> <p>7 = White / Brown</p> <p>8 = Brown</p>
Crossover Cable		SIDE 1	SIDE 2
	<p>SIDE 1</p> <p>SIDE 2</p>	<p>1 = White / Orange</p> <p>2 = Orange</p> <p>3 = White / Green</p> <p>4 = Blue</p> <p>5 = White / Blue</p> <p>6 = Green</p> <p>7 = White / Brown</p> <p>8 = Brown</p>	<p>1 = White / Green</p> <p>2 = Green</p> <p>3 = White / Orange</p> <p>4 = Blue</p> <p>5 = White / Blue</p> <p>6 = Orange</p> <p>7 = White / Brown</p> <p>8 = Brown</p>

Figure A-1: Straight-through and Crossover Cable

Please make sure your connected cables are with the same pin assignment and color as the above picture before deploying the cables into your network.

## APPENDIX B : GLOSSARY

### A

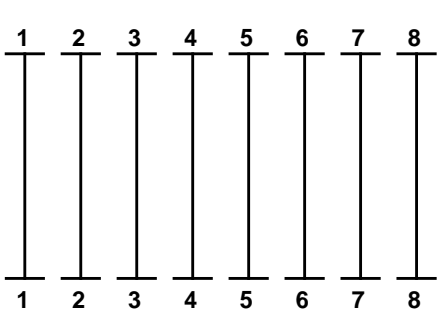
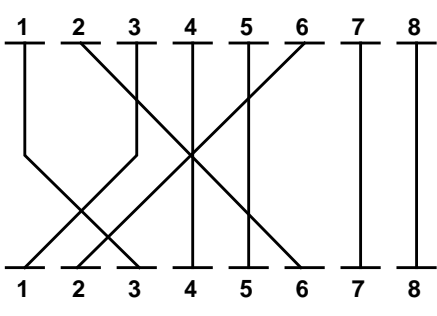
#### ACE

ACE is an acronym for Access Control Entry. It describes access permission associated with a particular ACE ID.

There are three ACE frame types (Ethernet Type, ARP, and IPv4) and two ACE actions (permit and deny).

The ACE also contains many detailed, different parameter options that are available for individual application.

#### ACL

ACL is an acronym for Access Control List. It is the list table of ACEs, containing access control entries that specify individual users or groups permitted or denied to specific traffic objects, such as a process or a program.

Each accessible traffic object contains an identifier to its ACL. The privileges determine whether there are specific traffic object access rights.

ACL implementations can be quite complex, for example, when the ACEs are prioritized for the various situation. In networking, the ACL refers to a list of service ports or network services that are available on a host or server, each with a list of hosts or servers permitted or denied to use the service. ACL can generally be configured to control inbound traffic, and in this context, they are similar to firewalls.

There are 3 web pages associated with the manual ACL configuration:

**ACL|Access Control List:** The web page shows the ACEs in a prioritized way, highest (top) to lowest (bottom). Default the table is empty. An ingress frame will only get a hit on one ACE even though there are more matching ACEs. The first matching ACE will take action (permit/deny) on that frame and a counter associated with that ACE is incremented. An ACE can be associated with a policy, 1 ingress port, or any ingress port (the whole switch). If an ACE Policy is created then that policy can be associated with a group of ports under the "Ports" web page. There are number of parameters that can be configured with an ACE. Read the web page help text to get further information for each of them. The maximum number of ACEs is 64.

**ACL|Ports:** The ACL Port configuration is used to assign a Policy ID to an ingress port. This is useful to group ports to obey the same traffic rules. Traffic Policy is created under the "Access Control List". You can you also set up specific traffic properties (Action / Rate Limiter / Port copy, etc) for each ingress port. They will though only apply if the frame gets past the ACE matching without getting matched. In that case a counter associated with that port is incremented. See the web page help text for each specific port property.

**ACL|Rate Limiters:** On this page, you can configure the rate limiters. There can be 15 different rate limiters,

each ranging from 1 to 1024K packets per second. Under "Ports" and "Access Control List", you can assign a Rate Limiter ID to the ACE(s) or ingress port(s).

## AES

AES is an acronym for Advanced Encryption Standard. The encryption key protocol is applied in 802.1x standard to improve WLAN security. It is an encryption standard by the U.S. government, which will replace DES and 3DES. AES has a fixed block size of 128 bits and a key size of 128, 192, or 256 bits.

## AMS

AMS is an acronym for Auto Media Select. AMS is used for dual media ports (ports supporting both copper (cu) and fiber (SFP) cables. AMS automatically determines if an SFP or a CU cable is inserted and switches to the corresponding media. If both SFP and cu cables are inserted, the port will select the preferred media.

## APS

APS is an acronym for Automatic Protection Switching. This protocol is used to secure switching that is done bidirectional in both ends of a protection group, as defined in G.8031.

## Aggregation

Using multiple ports in parallel to increase the link speed beyond the limits of a port and to increase the redundancy for higher availability.

*(Also Port Aggregation, Link Aggregation).*

## ARP

ARP is an acronym for Address Resolution Protocol. It is a protocol that used to convert an IP address into a physical address, such as an Ethernet address. ARP allows a host to communicate with other hosts when only the Internet address of its neighbors is known. Before using IP, the host sends a broadcast ARP request containing the Internet address of the desired destination system.

## ARP Inspection

ARP Inspection is a secure feature. Several types of attacks can be launched against a host or devices connected to Layer 2 networks by "poisoning" the ARP caches. This feature is used to block such attacks. Only valid ARP requests and responses can go through the switch device.

## Auto-Negotiation

Auto-negotiation is the process where two different devices establish the mode of operation and the speed settings that can be shared by those devices for a link.

## C

### CC

CC is an acronym for Continuity Check. It is a MEP functionality that is able to detect loss of continuity in a network by transmitting CCM frames to a peer MEP.

### CCM

CCM is an acronym for Continuity Check Message. It is a OAM frame transmitted from a MEP to its peer MEP and used to implement CC functionality.

### CDP

CDP is an acronym for Cisco Discovery Protocol.

## D

### DEI

DEI is an acronym for Drop Eligible Indicator. It is a 1-bit field in the VLAN tag.

### DES

DES is an acronym for Data Encryption Standard. It provides a complete description of a mathematical algorithm for encrypting (enciphering) and decrypting (deciphering) binary coded information.

Encrypting data converts it to an unintelligible form called cipher. Decrypting cipher converts the data back to its original form called plaintext. The algorithm described in this standard specifies both enciphering and deciphering operations which are based on a binary number called a key.

### DHCP

DHCP is an acronym for Dynamic Host Configuration Protocol. It is a protocol used for assigning dynamic IP addresses to devices on a network.

DHCP used by networked computers (clients) to obtain IP addresses and other parameters such as the default gateway, subnet mask, and IP addresses of DNS servers from a DHCP server.

The DHCP server ensures that all IP addresses are unique, for example, no IP address is assigned to a second client while the first client's assignment is valid (its lease has not expired). Therefore, IP address pool management is done by the server and not by a human network administrator.

Dynamic addressing simplifies network administration because the software keeps track of IP addresses rather than requiring an administrator to manage the task. This means that a new computer can be added to a network without the hassle of manually assigning it a unique IP address.

## DHCP Relay

DHCP Relay is used to forward and to transfer DHCP messages between the clients and the server when they are not on the same subnet domain.

The DHCP option 82 enables a DHCP relay agent to insert specific information into a DHCP request packets when forwarding client DHCP packets to a DHCP server and remove the specific information from a DHCP reply packets when forwarding server DHCP packets to a DHCP client. The DHCP server can use this information to implement IP address or other assignment policies. Specifically the option works by setting two sub-options: Circuit ID (option 1) and Remote ID (option2). The Circuit ID sub-option is supposed to include information specific to which circuit the request came in on. The Remote ID sub-option was designed to carry information relating to the remote host end of the circuit.

The definition of Circuit ID in the switch is 4 bytes in length and the format is "vlan\_id" "module\_id" "port\_no". The parameter of "vlan\_id" is the first two bytes represent the VLAN ID. The parameter of "module\_id" is the third byte for the module ID. The parameter of "port\_no" is the fourth byte and it means the port number. The Remote ID is 6 bytes in length, and the value is equal the DHCP relay agents MAC address.

## DHCP Snooping

DHCP Snooping is used to block intruder on the untrusted ports of the switch device when it tries to intervene by injecting a bogus DHCP reply packet to a legitimate conversation between the DHCP client and server.

## DNS

DNS is an acronym for **D**omain **N**ame **S**ystem. It stores and associates many types of information with domain names. Most importantly, DNS translates human-friendly domain names and computer hostnames into computer-friendly IP addresses. For example, the domain name www.example.com might translate to 192.168.0.1.

## DoS

DoS is an acronym for **D**enial of **S**ervice. In a denial-of-service (DoS) attack, an attacker attempts to prevent legitimate users from accessing information or services. By targeting at network sites or network connection, an attacker may be able to prevent network users from accessing email, web sites, online accounts (banking, etc.), or other services that rely on the affected computer.

## Dotted Decimal Notation

Dotted Decimal Notation refers to a method of writing IP addresses using decimal numbers and dots as separators between octets.

An IPv4 dotted decimal address has the form x.y.z.w, where x, y, z, and w are decimal numbers between 0 and 255.

## DSCP

DSCP is an acronym for **D**ifferentiated **S**ervices **C**ode **P**oint. It is a field in the header of IP packets for packet classification purposes.

## E

### EEE

EEE is an abbreviation for Energy Efficient Ethernet defined in IEEE 802.3az.

### EPS

EPS is an abbreviation for Ethernet Protection Switching defined in ITU/T G.8031.

### Ethernet Type

Ethernet Type, or EtherType, is a field in the Ethernet MAC header, defined by the Ethernet networking standard. It is used to indicate which protocol is being transported in an Ethernet frame.

## F

### FTP

FTP is an acronym for **F**ile **T**ransfer **P**rotocol. It is a transfer protocol that uses the Transmission Control Protocol (TCP) and provides file writing and reading. It also provides directory service and security features.

### Fast Leave

IGMP snooping Fast Leave processing allows the switch to remove an interface from the forwarding-table entry without first sending out group specific queries to the interface. The VLAN interface is pruned from the multicast tree for the multicast group specified in the original leave message. Fast-leave processing ensures optimal bandwidth management for all hosts on a switched network, even when multiple multicast groups are in use simultaneously.

## H

### HTTP

HTTP is an acronym for **H**ypertext **T**ransfer **P**rotocol. It is a protocol that used to transfer or convey information on the World Wide Web (WWW).

HTTP defines how messages are formatted and transmitted, and what actions Web servers and browsers should take in response to various commands. For example, when you enter a URL in your browser, this actually sends an HTTP command to the Web server directing it to fetch and transmit the requested web page. The other main standard that controls how the World Wide Web works is HTML, which covers how web pages are formatted and displayed.

Any Web server machine contains, in addition to the web page files it can serve, an HTTP daemon, a program that is designed to wait for HTTP requests and handle them when they arrive. The Web browser is an HTTP client, sending requests to server machines. An HTTP client initiates a request by establishing a

Transmission Control Protocol (TCP) connection to a particular port on a remote host (port 80 by default). An HTTP server listening on that port waits for the client to send a request message.

## HTTPS

HTTPS is an acronym for **H**ypertext **T**ransfer **P**rotocol over **S**ecure Socket Layer. It is used to indicate a secure HTTP connection.

HTTPS provide authentication and encrypted communication and is widely used on the World Wide Web for security-sensitive communication such as payment transactions and corporate logons.

HTTPS is really just the use of Netscape's Secure Socket Layer (SSL) as a sublayer under its regular HTTP application layering. (HTTPS uses port 443 instead of HTTP port 80 in its interactions with the lower layer, TCP/IP.) SSL uses a 40-bit key size for the RC4 stream encryption algorithm, which is considered an adequate degree of encryption for commercial exchange.

## I

## ICMP

ICMP is an acronym for **I**nternet **C**ontrol **M**essage **P**rotocol. It is a protocol that generated the error response, diagnostic or routing purposes. ICMP messages generally contain information about routing difficulties or simple exchanges such as time-stamp or echo transactions. For example, the PING command uses ICMP to test an Internet connection.

## IEEE 802.1X

IEEE 802.1X is an IEEE standard for port-based Network Access Control. It provides authentication to devices attached to a LAN port, establishing a point-to-point connection or preventing access from that port if authentication fails. With 802.1X, access to all switch ports can be centrally controlled from a server, which means that authorized users can use the same credentials for authentication from any point within the network.

## IGMP

IGMP is an acronym for **I**nternet **G**roup **M**anagement **P**rotocol. It is a communications protocol used to manage the membership of Internet Protocol multicast groups. IGMP is used by IP hosts and adjacent multicast routers to establish multicast group memberships. It is an integral part of the IP multicast specification, like ICMP for unicast connections. IGMP can be used for online video and gaming, and allows more efficient use of resources when supporting these uses.

## IGMP Querier

A router sends IGMP Query messages onto a particular link. This router is called the Querier.

## IMAP

IMAP is an acronym for **I**nternet **M**essage **A**ccess **P**rotocol. It is a protocol for email clients to retrieve email messages from a mail server.



IMAP is the protocol that IMAP clients use to communicate with the servers, and SMTP is the protocol used to transport mail to an IMAP server.

The current version of the Internet Message Access Protocol is IMAP4. It is similar to Post Office Protocol version 3 (POP3), but offers additional and more complex features. For example, the IMAP4 protocol leaves your email messages on the server rather than downloading them to your computer. If you wish to remove your messages from the server, you must use your mail client to generate local folders, copy messages to your local hard drive, and then delete and expunge the messages from the server.

## IP

IP is an acronym for **I**nternet **P**rotocol. It is a protocol used for communicating data across a internet network.

IP is a "best effort" system, which means that no packet of information sent over it is assured to reach its destination in the same condition it was sent. Each device connected to a Local Area Network (LAN) or Wide Area Network (WAN) is given an Internet Protocol address, and this IP address is used to identify the device uniquely among all other devices connected to the extended network.

The current version of the Internet protocol is IPv4, which has 32-bits Internet Protocol addresses allowing for in excess of four billion unique addresses. This number is reduced drastically by the practice of webmasters taking addresses in large blocks, the bulk of which remain unused. There is a rather substantial movement to adopt a new version of the Internet Protocol, IPv6, which would have 128-bits Internet Protocol addresses. This number can be represented roughly by a three with thirty-nine zeroes after it. However, IPv4 is still the protocol of choice for most of the Internet.

## IPMC

IPMC is an acronym for **I**P **M**ulti**C**ast.

## IP Source Guard

IP Source Guard is a secure feature used to restrict IP traffic on DHCP snooping untrusted ports by filtering traffic based on the DHCP Snooping Table or manually configured IP Source Bindings. It helps prevent IP spoofing attacks when a host tries to spoof and use the IP address of another host.

## L

### LACP

LACP is an IEEE 802.3ad standard protocol. The **L**ink **A**ggregation **C**ontrol **P**rotocol allows bundling several physical ports together to form a single logical port.

### LLDP

LLDP is an IEEE 802.1ab standard protocol.

The **L**ink **L**ayer **D**iscovery **P**rotocol(LLDP) specified in this standard allows stations attached to an IEEE 802 LAN to advertise, to other stations attached to the same IEEE 802 LAN, the major capabilities provided by the system

incorporating that station, the management address or addresses of the entity or entities that provide management of those capabilities, and the identification of the stations point of attachment to the IEEE 802 LAN required by those management entities. The information distributed via this protocol is stored by its recipients in a standard Management Information Base (MIB), making it possible for the information to be accessed by a Network Management System (NMS) using a management protocol such as the Simple Network Management Protocol (SNMP).

## LLDP-MED

LLDP-MED is an extension of IEEE 802.1ab and is defined by the telecommunication industry association (TIA-1057).

## LOC

LOC is an acronym for Loss Of Connectivity and is detected by a MEP and is indicating lost connectivity in the network. Can be used as a switch criteria by EPS

# M

## MAC Table

Switching of frames is based upon the DMAC address contained in the frame. The switch builds up a table that maps MAC addresses to switch ports for knowing which ports the frames should go to (based upon the DMAC address in the frame). This table contains both static and dynamic entries. The static entries are configured by the network administrator if the administrator wants to do a fixed mapping between the DMAC address and switch ports.

The frames also contain a MAC address (SMAC address), which shows the MAC address of the equipment sending the frame. The SMAC address is used by the switch to automatically update the MAC table with these dynamic MAC addresses. Dynamic entries are removed from the MAC table if no frame with the corresponding SMAC address have been seen after a configurable age time.

## MEP

MEP is an acronym for Maintenance Entity Endpoint and is an endpoint in a Maintenance Entity Group (ITU-T Y.1731).

## MD5

MD5 is an acronym for Message-Digest algorithm 5. MD5 is a message digest algorithm, used cryptographic hash function with a 128-bit hash value. It was designed by Ron Rivest in 1991. MD5 is officially defined in RFC 1321 - The MD5 Message-Digest Algorithm.

## Mirroring

For debugging network problems or monitoring network traffic, the switch system can be configured to mirror frames from multiple ports to a mirror port. (In this context, mirroring a frame is the same as copying the frame.)

Both incoming (source) and outgoing (destination) frames can be mirrored to the mirror port.

## MLD

MLD is an acronym for **M**ulticast **L**istener **D**iscovery for IPv6. MLD is used by IPv6 routers to discover multicast listeners on a directly attached link, much as IGMP is used in IPv4. The protocol is embedded in ICMPv6 instead of using a separate protocol.

## MVR

Multicast VLAN Registration (MVR) is a protocol for Layer 2 (IP)-networks that enables multicast-traffic from a source VLAN to be shared with subscriber-VLANs. The main reason for using MVR is to save bandwidth by preventing duplicate multicast streams being sent in the core network, instead the stream(s) are received on the MVR-VLAN and forwarded to the VLANs where hosts have requested it/them (Wikipedia).

## N

### NAS

NAS is an acronym for Network Access Server. The NAS is meant to act as a gateway to guard access to a protected source. A client connects to the NAS, and the NAS connects to another resource asking whether the client's supplied credentials are valid. Based on the answer, the NAS then allows or disallows access to the protected resource. An example of a NAS implementation is IEEE 802.1X.

### NetBIOS

NetBIOS is an acronym for **N**etwork **B**asic **I**nput/**O**utput **S**ystem. It is a program that allows applications on separate computers to communicate within a Local Area Network (LAN), and it is not supported on a Wide Area Network (WAN).

The NetBIOS giving each computer in the network both a NetBIOS name and an IP address corresponding to a different host name, provides the session and transport services described in the Open Systems Interconnection (OSI) model.

### NFS

NFS is an acronym for **N**etwork **F**ile **S**ystem. It allows hosts to mount partitions on a remote system and use them as though they are local file systems.

NFS allows the system administrator to store resources in a central location on the network, providing authorized users continuous access to them, which means NFS supports sharing of files, printers, and other resources as persistent storage over a computer network.

### NTP

NTP is an acronym for **N**etwork **T**ime **P**rotocol, a network protocol for synchronizing the clocks of computer systems. NTP uses UDP (datagrams) as transport layer.

## O

## OAM

OAM is an acronym for **O**peration **A**dministration and **M**aintenance. It is a protocol described in ITU-T Y.1731 used to implement carrier Ethernet functionality. MEP functionality like CC and RDI is based on this.

## Optional TLVs.

An LLDP frame contains multiple TLVs. For some TLVs it is configurable if the switch includes the TLV in the LLDP frame. These TLVs are known as optional TLVs. If an optional TLV is disabled the corresponding information is not included in the LLDP frame.

## OUI

OUI is the organizationally unique identifier. An OUI address is a globally unique identifier assigned to a vendor by IEEE. You can determine which vendor a device belongs to according to the OUI address which forms the first 24 bits of an MAC address.

## P

### PCP

PCP is an acronym for Priority Code Point. It is a 3-bit field storing the priority level for the 802.1Q frame. It is also known as User Priority.

### PD

PD is an acronym for **P**owered **D**evice. In a PoE system the power is delivered from a PSE (power sourcing equipment) to a remote device. The remote device is called a PD.

### PHY

PHY is an abbreviation for Physical Interface Transceiver and is the device that implement the Ethernet physical layer (IEEE-802.3).

### PING

Ping is a program that sends a series of packets over a network or the Internet to a specific computer in order to generate a response from that computer. The other computer responds with an acknowledgment that it received the packets. Ping was created to verify whether a specific computer on a network or the Internet exists and is connected.

Ping uses Internet Control Message Protocol (ICMP) packets. The Ping Request is the packet from the origin computer, and the Ping Reply is the packet response from the target.

### Policer

A policer can limit the bandwidth of received frames. It is located in front of the ingress queue.

## POP3

POP3 is an acronym for **P**ost **O**ffice **P**rotocol version 3. It is a protocol for email clients to retrieve email messages from a mail server.

POP3 is designed to delete mail on the server as soon as the user has downloaded it. However, some implementations allow users or an administrator to specify that mail be saved for some period of time. POP can be thought of as a "store-and-forward" service.

An alternative protocol is Internet Message Access Protocol (IMAP). IMAP provides the user with more capabilities for retaining e-mail on the server and for organizing it in folders on the server. IMAP can be thought of as a remote file server.

POP and IMAP deal with the receiving of e-mail and are not to be confused with the Simple Mail Transfer Protocol (SMTP). You send e-mail with SMTP, and a mail handler receives it on your recipient's behalf. Then the mail is read using POP or IMAP. IMAP4 and POP3 are the two most prevalent Internet standard protocols for e-mail retrieval. Virtually all modern e-mail clients and servers support both.

## PPPoE

PPPoE is an acronym for Point-to-Point Protocol over Ethernet. It is a network protocol for encapsulating Point-to-Point Protocol (PPP) frames inside Ethernet frames. It is used mainly with ADSL services where individual users connect to the ADSL transceiver (modem) over Ethernet and in plain Metro Ethernet networks (Wikipedia).

## Private VLAN

In a private VLAN, communication between ports in that private VLAN is not permitted. A VLAN can be configured as a private VLAN.

## PTP

PTP is an acronym for Precision Time Protocol, a network protocol for synchronizing the clocks of computer systems.

## Q

### QCE

QCE is an acronym for **Q**oS **C**ontrol **E**ntry. It describes QoS class associated with a particular QCE ID.

There are six QCE frame types: Ethernet Type, VLAN, UDP/TCP Port, DSCP, TOS, and Tag Priority. Frames can be classified by one of 4 different QoS classes: "Low", "Normal", "Medium", and "High" for individual application.

### QCL

QCL is an acronym for **Q**oS **C**ontrol **L**ist. It is the list table of QCEs, containing QoS control entries that classify to a specific QoS class on specific traffic objects.

Each accessible traffic object contains an identifier to its QCL. The privileges determine specific traffic object to specific QoS class.

## QL

QL In SyncE this is the Quality Level of a given clock source. This is received on a port in a SSM indicating the quality of the clock received in the port.

## QoS

QoS is an acronym for **Q**uality **o**f **S**ervice. It is a method to guarantee a bandwidth relationship between individual applications or protocols.

A communications network transports a multitude of applications and data, including high-quality video and delay-sensitive data such as real-time voice. Networks must provide secure, predictable, measurable, and sometimes guaranteed services.

Achieving the required QoS becomes the secret to a successful end-to-end business solution. Therefore, QoS is the set of techniques to manage network resources.

## QoS class

Every incoming frame is classified to a QoS class, which is used throughout the device for providing queuing, scheduling and congestion control guarantees to the frame according to what was configured for that specific QoS class. There is a one to one mapping between QoS class, queue and priority. A QoS class of 0 (zero) has the lowest priority.

# R

## RARP

RARP is an acronym for **R**everse **A**ddress **R**esolution **P**rotocol. It is a protocol that is used to obtain an IP address for a given hardware address, such as an Ethernet address. RARP is the complement of ARP.

## RADIUS

RADIUS is an acronym for **R**emote **A**uthentication **D**ial In **U**ser **S**ervice. It is a networking protocol that provides centralized access, authorization and accounting management for people or computers to connect and use a network service.

## RDI

RDI is an acronym for **R**emote **D**efect **I**ndication. It is an OAM functionality that is used by a MEP to indicate defect detected to the remote peer MEP

## Router Port

A router port is a port on the Ethernet switch that leads switch towards the Layer 3 multicast device.

## RSTP

In 1998, the IEEE with document 802.1w introduced an evolution of STP: the **R**apid **S**panning **T**ree **P**rotocol, which provides for faster spanning tree convergence after a topology change. Standard IEEE 802.1D-2004 now incorporates RSTP and obsoletes STP, while at the same time being backwards-compatible with STP.

## S

### SAMBA

Samba is a program running under UNIX-like operating systems that provides seamless integration between UNIX and Microsoft Windows machines. Samba acts as file and print servers for Microsoft Windows, IBM OS/2, and other SMB client machines. Samba uses the Server Message Block (SMB) protocol and Common Internet File System (CIFS), which is the underlying protocol used in Microsoft Windows networking.

Samba can be installed on a variety of operating system platforms, including Linux, most common Unix platforms, OpenVMS, and IBM OS/2.

Samba can also register itself with the master browser on the network so that it would appear in the listing of hosts in Microsoft Windows "Neighborhood Network".

### SHA

SHA is an acronym for **S**ecure **H**ash **A**lgorithm. It designed by the National Security Agency (NSA) and published by the NIST as a U.S. Federal Information Processing Standard. Hash algorithms compute a fixed-length digital representation (known as a message digest) of an input data sequence (the message) of any length.

### Shaper

A shaper can limit the bandwidth of transmitted frames. It is located after the ingress queues.

### SMTP

SMTP is an acronym for **S**imple **M**ail **T**ransfer **P**rotocol. It is a text-based protocol that uses the Transmission Control Protocol (TCP) and provides a mail service modeled on the FTP file transfer service. SMTP transfers mail messages between systems and notifications regarding incoming mail.

### SNAP

The SubNetwork Access Protocol (SNAP) is a mechanism for multiplexing, on networks using IEEE 802.2 LLC, more protocols than can be distinguished by the 8-bit 802.2 Service Access Point (SAP) fields. SNAP supports identifying protocols by Ethernet type field values; it also supports vendor-private protocol identifier.

### SNMP

SNMP is an acronym for **S**imple **N**etwork **M**anagement **P**rotocol. It is part of the Transmission Control Protocol/Internet Protocol (TCP/IP) protocol for network management. SNMP allow diverse network objects to participate in a network management architecture. It enables network management systems to learn network problems by receiving traps or change notices from network devices implementing SNMP.

## SNTP

SNTP is an acronym for **S**imple **N**etwork **T**ime **P**rotocol, a network protocol for synchronizing the clocks of computer systems. SNTP uses UDP (datagrams) as transport layer.

## SPROUT

**S**tack **P**rotocol using **R**outing **T**echnology. An advanced protocol for almost instantaneous discovery of topology changes within a stack as well as election of a master switch. SPROUT also calculates parameters for setting up each switch to perform shortest path forwarding within the stack.

## SSID

**S**ervice **S**et **I**dentifier is a name used to identify the particular 802.11 wireless LANs to which a user wants to attach. A client device will receive broadcast messages from all access points within range advertising their SSIDs, and can choose one to connect to based on pre-configuration, or by displaying a list of SSIDs in range and asking the user to select one (wikipedia).

## SSH

SSH is an acronym for **S**ecure **S**hell. It is a network protocol that allows data to be exchanged using a secure channel between two networked devices. The encryption used by SSH provides confidentiality and integrity of data over an insecure network. The goal of SSH was to replace the earlier rlogin, TELNET and rsh protocols, which did not provide strong authentication or guarantee confidentiality (Wikipedia).

## SSM

SSM In SyncE this is an abbreviation for Synchronization Status Message and is containing a QL indication.

## STP

**S**panning **T**ree **P**rotocol is an OSI layer-2 protocol which ensures a loop free topology for any bridged LAN. The original STP protocol is now obsolete by RSTP.

## SyncE

SyncE Is an abbreviation for Synchronous Ethernet. This functionality is used to make a network 'clock frequency' synchronized. Not to be confused with real time clock synchronized (IEEE 1588).

## T

### TACACS+

TACACS+ is an acronym for **T**erminal **A**ccess **C**ontroller **A**ccess **C**ontrol **S**ystem **P**lus. It is a networking protocol which provides access control for routers, network access servers and other networked computing devices via one or more centralized servers. TACACS+ provides separate authentication, authorization and accounting services.

### Tag Priority

Tag Priority is a 3-bit field storing the priority level for the 802.1Q frame.

### TCP



TCP is an acronym for **T**ransmission **C**ontrol **P**rotocol. It is a communications protocol that uses the Internet Protocol (IP) to exchange the messages between computers.

The TCP protocol guarantees reliable and in-order delivery of data from sender to receiver and distinguishes data for multiple connections by concurrent applications (for example, Web server and e-mail server) running on the same host.

The applications on networked hosts can use TCP to create connections to one another. It is known as a connection-oriented protocol, which means that a connection is established and maintained until such time as the message or messages to be exchanged by the application programs at each end have been exchanged. TCP is responsible for ensuring that a message is divided into the packets that IP manages and for reassembling the packets back into the complete message at the other end.

Common network applications that use TCP include the World Wide Web (WWW), e-mail, and File Transfer Protocol (FTP).

## TELNET

TELNET is an acronym for **T**eletype **N**etwork. It is a terminal emulation protocol that uses the Transmission Control Protocol (TCP) and provides a virtual connection between TELNET server and TELNET client.

TELNET enables the client to control the server and communicate with other servers on the network. To start a Telnet session, the client user must log in to a server by entering a valid username and password. Then, the client user can enter commands through the Telnet program just as if they were entering commands directly on the server console.

## TFTP

TFTP is an acronym for **T**rivial **F**ile **T**ransfer **P**rotocol. It is transfer protocol that uses the User Datagram Protocol (UDP) and provides file writing and reading, but it does not provides directory service and security features.

## Toss

Toss is an acronym for **T**ype **o**f **S**ervice. It is implemented as the IPv4 Toss priority control. It is fully decoded to determine the priority from the 6-bit Toss field in the IP header. The most significant 6 bits of the Toss field are fully decoded into 64 possibilities, and the singular code that results is compared against the corresponding bit in the IPv4 ToS priority control bit (0~63).

## TLV

TLV is an acronym for **T**ype **L**ength **V**alue. A LLDP frame can contain multiple pieces of information. Each of these pieces of information is known as TLV.

## TKIP

TKIP is an acronym for **T**emporal **K**ey **I**ntegrity **P**rotocol. It used in WPA to replace WEP with a new encryption algorithm. TKIP comprises the same encryption engine and RC4 algorithm defined for WEP. The key used for

encryption in TKIP is 128 bits and changes the key used for each packet.

## U

### UDP

UDP is an acronym for **U**ser **D**atagram **P**rotocol. It is a communications protocol that uses the Internet Protocol (IP) to exchange the messages between computers.

UDP is an alternative to the Transmission Control Protocol (TCP) that uses the Internet Protocol (IP). Unlike TCP, UDP does not provide the service of dividing a message into packet datagrams, and UDP doesn't provide reassembling and sequencing of the packets. This means that the application program that uses UDP must be able to make sure that the entire message has arrived and is in the right order. Network applications that want to save processing time because they have very small data units to exchange may prefer UDP to TCP.

UDP provides two services not provided by the IP layer. It provides port numbers to help distinguish different user requests and, optionally, a checksum capability to verify that the data arrived intact.

Common network applications that use UDP include the Domain Name System (DNS), streaming media applications such as IPTV, Voice over IP (VoIP), and Trivial File Transfer Protocol (TFTP).

### UPnP

UPnP is an acronym for **U**niversal **P**lug and **P**lay. The goals of UPnP are to allow devices to connect seamlessly and to simplify the implementation of networks in the home (data sharing, communications, and entertainment) and in corporate environments for simplified installation of computer components

### User Priority

User Priority is a 3-bit field storing the priority level for the 802.1Q frame.

## V

### VLAN

A method to restrict communication between switch ports. VLANs can be used for the following applications:

**VLAN unaware switching:** This is the default configuration. All ports are VLAN unaware with Port VLAN ID 1 and members of VLAN 1. This means that MAC addresses are learned in VLAN 1, and the switch does not remove or insert VLAN tags.

**VLAN aware switching:** This is based on the IEEE 802.1Q standard. All ports are VLAN aware. Ports connected to VLAN aware switches are members of multiple VLANs and transmit tagged frames. Other ports are members of one VLAN, set up with this Port VLAN ID, and transmit untagged frames.

**Provider switching:** This is also known as Q-in-Q switching. Ports connected to subscribers are VLAN unaware, members of one VLAN, and set up with this unique Port VLAN ID. Ports connected to the service provider are VLAN aware, members of multiple VLANs, and set up to tag all frames. Untagged frames received on a subscriber port are forwarded to the provider port with a single VLAN tag. Tagged frames received on a subscriber port are forwarded to the provider port with a double VLAN tag.

## VLAN ID

VLAN ID is a 12-bit field specifying the VLAN to which the frame belongs.

## Voice VLAN

Voice VLAN is VLAN configured specially for voice traffic. By adding the ports with voice devices attached to voice VLAN, we can perform QoS-related configuration for voice data, ensuring the transmission priority of voice traffic and voice quality.

# W

## WEP

WEP is an acronym for **W**ired **E**quivalent **P**rivacy. WEP is a deprecated algorithm to secure IEEE 802.11 wireless networks. Wireless networks broadcast messages using radio, so are more susceptible to eavesdropping than wired networks. When introduced in 1999, WEP was intended to provide confidentiality comparable to that of a traditional wired network (Wikipedia).

## Wi-Fi

Wi-Fi is an acronym for **W**ireless **F**idelity. It is meant to be used generically when referring of any type of 802.11 network, whether 802.11b, 802.11a, dual-band, etc. The term is promulgated by the Wi-Fi Alliance.

## WPA

WPA is an acronym for **W**i-Fi **P**rotected **A**ccess. It was created in response to several serious weaknesses researchers had found in the previous system, Wired Equivalent Privacy (WEP). WPA implements the majority of the IEEE 802.11i standard, and was intended as an intermediate measure to take the place of WEP while 802.11i was prepared. WPA is specifically designed to also work with pre-WPA wireless network interface cards (through firmware upgrades), but not necessarily with first generation wireless access points. WPA2 implements the full standard, but will not work with some older network cards (Wikipedia).

## WPA-PSK

WPA-PSK is an acronym for **W**i-Fi **P**rotected **A**ccess - **P**re **S**hared **K**ey. WPA was designed to enhance the security of wireless networks. There are two flavors of WPA: enterprise and personal. Enterprise is meant for use with an IEEE 802.1X authentication server, which distributes different keys to each user. Personal WPA utilizes less scalable 'pre-shared key' (PSK) mode, where every allowed computer is given the same passphrase. In PSK mode, security depends on the strength and secrecy of the passphrase. The design of WPA is based on a Draft 3 of the IEEE 802.11i standard (Wikipedia)

## WPA-Radius

WPA-Radius is an acronym for **W**i-Fi **P**rotected **A**ccess - Radius (802.1X authentication server). WPA was designed to enhance the security of wireless networks. There are two flavors of WPA: enterprise and personal. Enterprise is meant for use with an IEEE 802.1X authentication server, which distributes different keys to each user. Personal WPA utilizes less scalable 'pre-shared key' (PSK) mode, where every allowed computer is given the same passphrase. In PSK mode, security depends on the strength and secrecy of the passphrase. The design of WPA is based on a Draft 3 of the IEEE 802.11i standard (Wikipedia)

## WPS

WPS is an acronym for **W**i-Fi **P**rotected **S**etup. It is a standard for easy and secure establishment of a wireless home network. The goal of the WPS protocol is to simplify the process of connecting any home device to the wireless network (Wikipedia).

## WRED

WRED is an acronym for **W**eighted **R**andom **E**arly **D**etection. It is an active queue management mechanism that provides preferential treatment of higher priority frames when traffic builds up within a queue. A frame's DP level is used as input to WRED. A higher DP level assigned to a frame results in a higher probability that the frame is dropped during times of congestion.

## WTR

WTR is an acronym for **W**ait **T**o **R**estore. This is the time a fail on a resource has to be 'not active' before restoration back to this (previously failing) resource is done.